

General purpose operational amplifier

MC/SA1458/MC1558

DESCRIPTION

The MC1458 is a high-performance operational amplifier with high open-loop gain, internal compensation, high common-mode range and exceptional temperature stability. The MC1458 is short-circuit protected.

The MC1458/SA1458/MC1558 consists of a pair of 741 operational amplifiers on a single chip.

FEATURES

- Internal frequency compensation
- Short-circuit protection
- Excellent temperature stability
- High input voltage range
- No latch-up
- 1558/1458 are 2 "op amps" in space of one 741 package

PIN CONFIGURATION

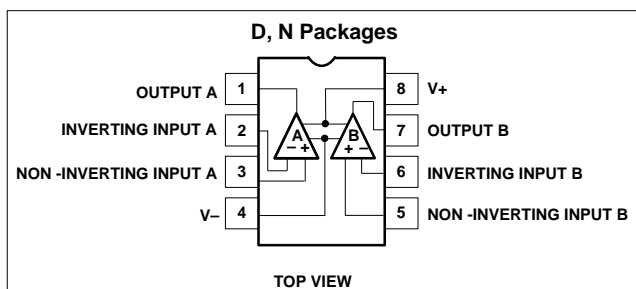

ORDERING INFORMATION

DESCRIPTION	TEMPERATURE RANGE	ORDER CODE	DWG #
8-Pin Plastic Small Outline (SO) Package	0 to +70°C	MC1458D	0174C
8-Pin Plastic Dual In-Line Package (DIP)	0 to +70°C	MC1458N	0404B
8-Pin Plastic Small Outline (SO) Package	-40°C to +85°C	SA1458D	0174C
8-Pin Plastic Dual In-Line Package (DIP)	-40°C to +85°C	SA1458N	0404B
8-Pin Plastic Dual In-Line Package (DIP)	-55°C to +125°C	MC1558N	0404B

ABSOLUTE MAXIMUM RATINGS

SYMBOL	PARAMETER	RATING	UNIT
V _S	Supply voltage		
	MC1458	±18	V
	SA1458	±18	V
	MC1558	±22	V
T _J	Junction temperature	+150	°C
P _{D MAX}	Maximum power dissipation, T _A =25°C (still-air) ¹		
	N package	1160	mW
	D package	780	mW
V _{DIFF}	Differential input voltage	±30	V
V _{IN}	Input voltage ²	±15	V
	Output short-circuit duration	Continuous	
T _A	Operating ambient temperature range		
	MC1458	0 to +70	°C
	SA1458	-40 to +85	°C
	MC1558	-55 to +125	°C
T _{STG}	Storage temperature range	-65 to +150	°C
T _{SOLD}	Lead soldering temperature (10sec max)	300	°C

NOTES:

1. The following derating factors should be applied above 25°C; N package at 9.3mW/°C; D package at 6.2mW/°C
2. For supply voltages less than ±15V, the absolute maximum input voltage is equal to the supply voltage.

General purpose operational amplifier

MC/SA1458/MC1558

EQUIVALENT SCHEMATIC

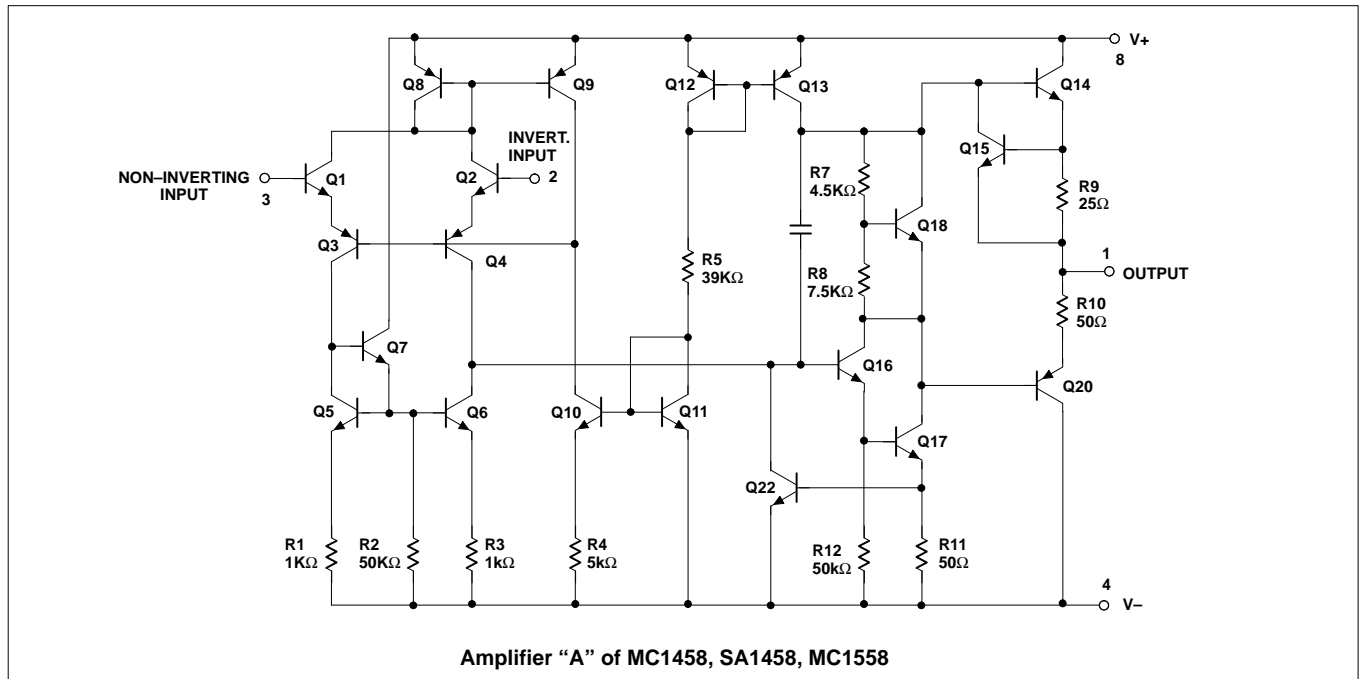

DC ELECTRICAL CHARACTERISTICS

$T_A=25^{\circ}\text{C}$, $V_S=\pm 15\text{V}$, unless otherwise specified.

SYMBOL	PARAMETER	TEST CONDITIONS	MC1558			UNIT
			Min	Typ	Max	
V_{OS}	Offset voltage	$R_S=10\text{k}\Omega$		1.0	5.0	mV
ΔV_{OS}	Offset voltage	$R_S=10\text{k}\Omega$, over temperature		10	6.0	$\mu\text{V}/^{\circ}\text{C}$
I_{OS}	Offset current	Over temperature		20	200	nA
ΔI_{OS}	Offset current	Over temperature		0.10	500	$\text{nA}/^{\circ}\text{C}$
I_{BIAS}	Input bias current	Over temperature		80	500	nA
ΔI_{BIAS}	Bias current	Over temperature		1.0	1500	$\text{nA}/^{\circ}\text{C}$
V_{OUT}	Output voltage swing	$R_L=10\text{k}\Omega$, over temperature $R_L=2\text{k}\Omega$, over temperature	± 12 ± 10	± 14 ± 13		V
A_{VOL}	Large-signal voltage gain	$R_L=2\text{k}\Omega, V_O=\pm 10\text{V}$ $R_L=2\text{k}\Omega, V_O=\pm$ temperature	50 20	100		V/mV
	Offset voltage adjustment range			± 30		mV
PSRR	Power supply rejection ratio	$R_S \leq 10\text{k}\Omega$		30	150	$\mu\text{V}/\text{V}$
CMRR	Common mode rejection ratio		70	90		dB
I_{CC}	Supply current			2.3	5.0	mA
V_{IN}	Input voltage range		± 12	± 13		V
P_D	Power consumption			70	150	mW
	Channel separation			120		dB
R_{OUT}	Output resistance			75		Ω
I_{SC}	Output short-circuit current		10	25	60	mA

General purpose operational amplifier

MC/SA1458/MC1558

DC ELECTRICAL CHARACTERISTICS (Continued)T_A=25°C V_{CC}=±15V, unless otherwise specified.

SYMBOL	PARAMETER	TEST CONDITIONS	MC1458			SA1458			UNIT
			Min	Typ	Max	Min	Typ	Max	
V _{OS}	Offset voltage	R _S =10kΩ		2.0	6.0		2.0	6.0	mV
		R _S =10kΩ, over temp.			7.5			7.5	mV
ΔV _{OS}	Offset voltage	Over temperature		12			12		μV/°C
I _{OS}	Offset current	Over temperature		20	200		20	200	nA
		Over temperature			300			500	nA
ΔI _{OS}	Offset current	Over temperature		0.10			0.10		nA/°C
I _{BIAS}	Input bias current	Over temperature		80	500		80	500	nA
		Over temperature			800			1500	nA
ΔI _{BIAS}	Bias current	Over temperature		1.0			1.0		nA/°C
V _{OUT}	Output voltage swing	R _L =10kΩ, over temp.	±12	±14		±12	±14		V
		R _L =2kΩ, over temp.	±10	±13		±10	±13		
A _{VOL}	Large-signal voltage gain	R _L =2kΩ, V _O =±10V	25	200		20	200		V/mV
		R _L =2kΩ, V _O =±10V, Over temperature	15			15			V/mV
	Offset voltage adjustment range			±30			±30		mV
PSRR	Power supply rejection ratio	R _S ≤10kΩ		30	150		30	150	μV/V
CMRR	Common-mode rejection ratio		70	90		70	90		dB
I _{CC}	Supply current			2.3	5.6		2.3	5.6	mA
V _{IN}	Input voltage range		±12	±13		±12	±13		V
R _{IN}	Input resistance		0.3	1		0.3	1		MΩ
P _D	Power consumption			70	170		70	170	mW
	Channel separation			120			120		dB
I _{SC}	Output short-circuit current			25			25		mA

AC ELECTRICAL CHARACTERISTICST_A=25°C V_S=±15V, unless otherwise specified.

SYMBOL	PARAMETER	TEST CONDITIONS	MC1458, SA1458, MC1558			UNIT
			Min	Typ	Max	
R _{IN}	Parallel input resistance	Open-loop, f=20Hz	0.3			MΩ
	Common-mode input impedance	f=20Hz		200		MΩ
	Equivalent input noise voltage	A _V =100, R _S =10kΩ, BW=1.0kHz, f=1.0kHz		30		nV/√Hz
BW	Power bandwidth	A _V =1, R _L =2.0kΩ, THD≤5%, V _{OUT} =20V _{P-P}		14		kHz
	Phase margin			65		degrees
A _V	Gain margin			11		dB
	Unity gain crossover frequency	Open loop		1.0		MHz
t _R	Transient response unity gain	V _{IN} =20mV, R _L =2kΩ, C _L ≤100pF				
	Rise time			0.3		μs
	Overshoot			5.0		%
SR	Slew rate	C _L ≤100pF, R _L ≥2kΩ, V _{IN} =±10V		0.8		V/μs

General purpose operational amplifier

MC/SA1458/MC1558

TYPICAL PERFORMANCE CHARACTERISTICS

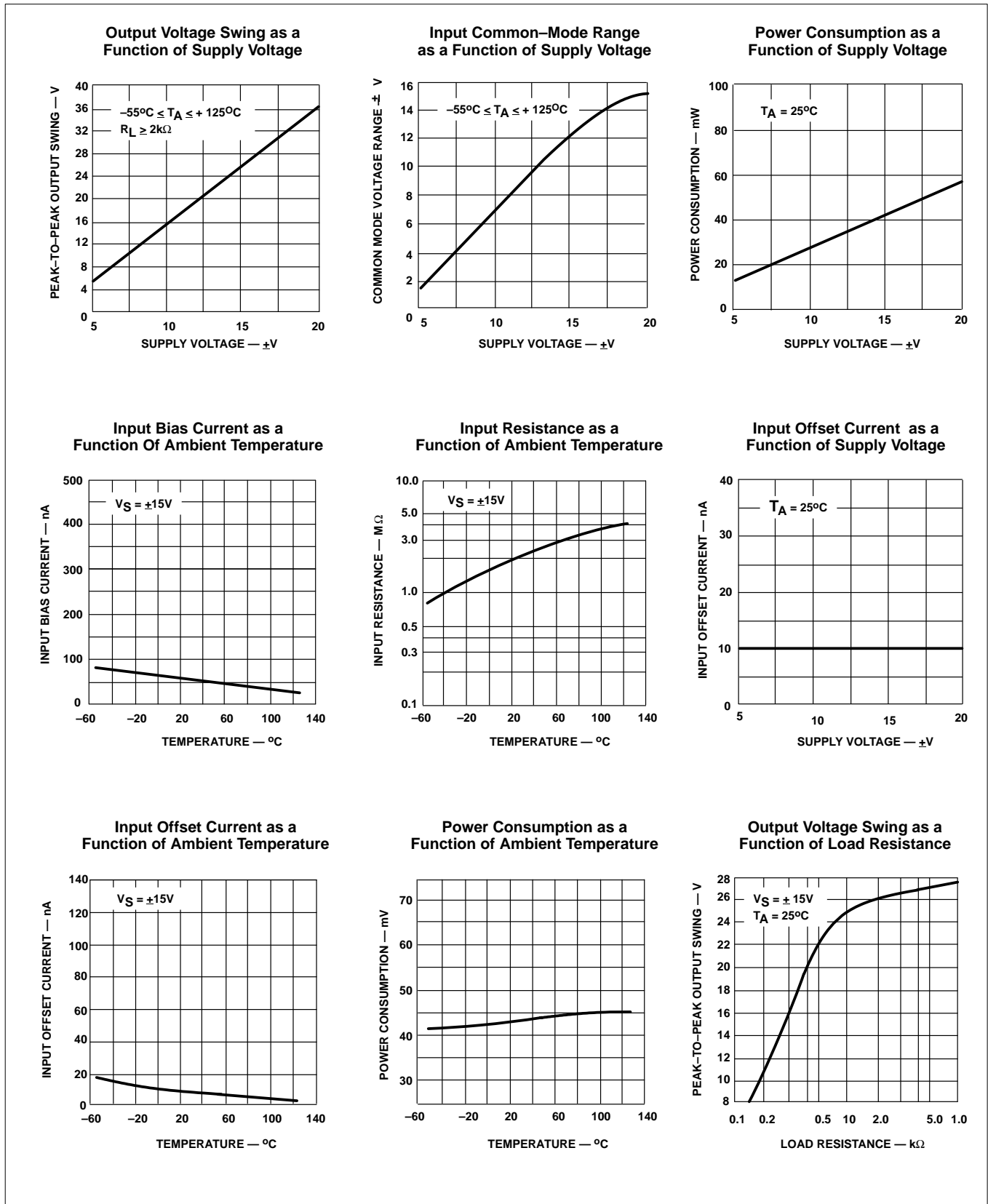

General purpose operational amplifier

MC/SA1458/MC1558

TYPICAL PERFORMANCE CHARACTERISTICS (Continued)

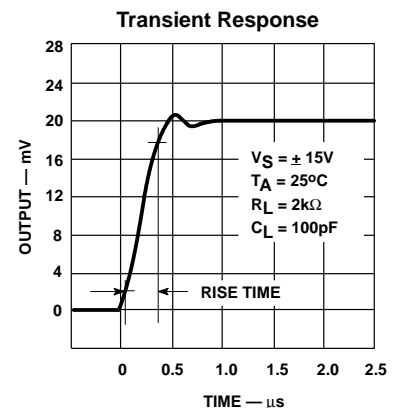
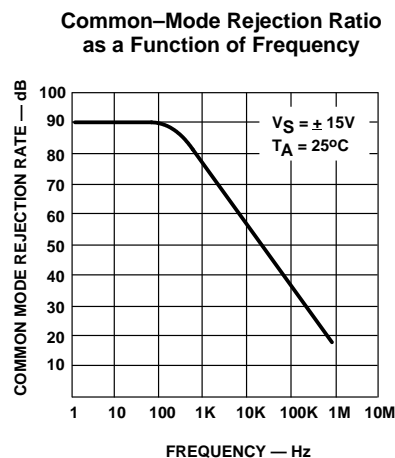
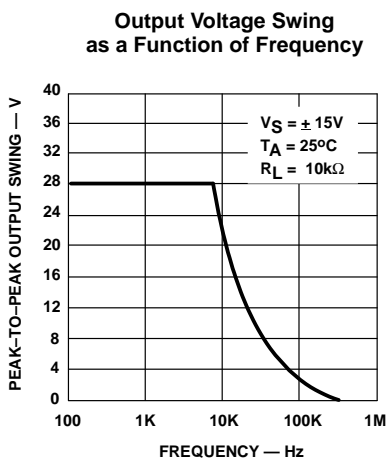
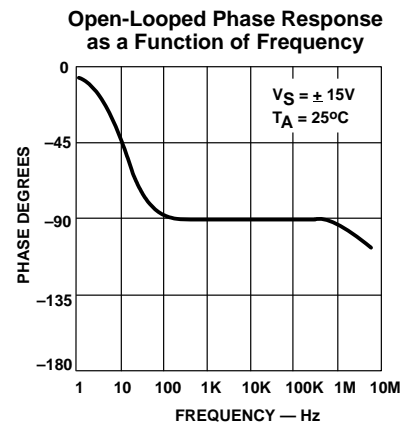
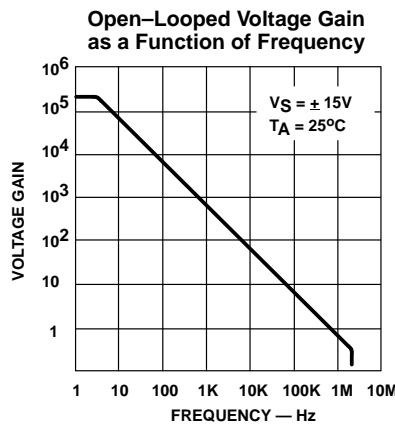
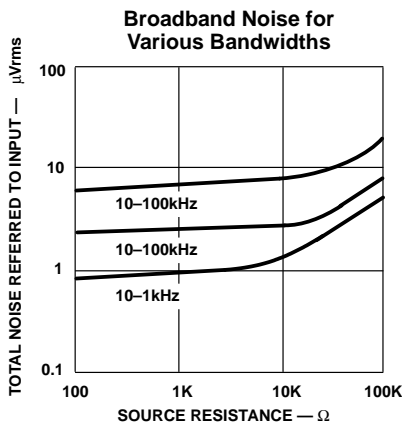
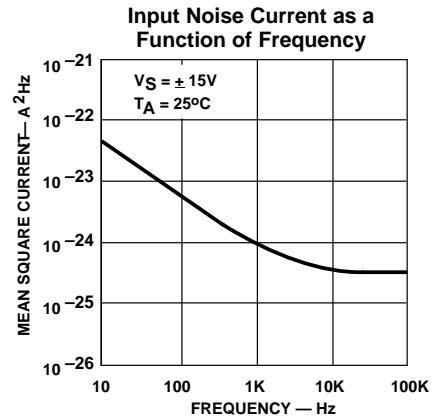
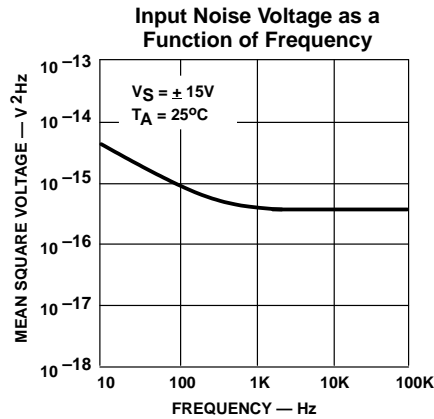
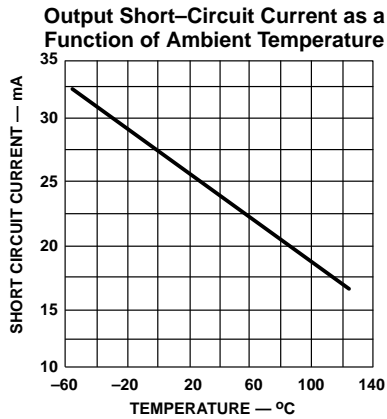

General purpose operational amplifier

MC/SA1458/MC1558

TYPICAL PERFORMANCE CHARACTERISTICS (Continued)

