

Applications

- Ku-band Communications



Product Features

- Frequency Range: 14.0 – 15.35 GHz
- P_{SAT} : 43 dBm
- PAE: 27%
- Small Signal Gain: 35 dB
- Integrated Voltage Detector
- Bias: $V_D = 25$ V, $I_{DQ} = 1.0$ A, $V_G = -2.4$ V Typical
- Package Dimensions: 11.38 X 17.33 X 3.0 mm

Functional Block Diagram

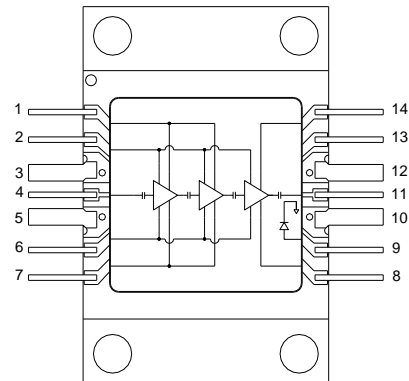

General Description

TriQuint's TGA2579-2-FL is a power amplifier operating from 14.0 to 15.35 GHz and typically provides 43 dBm of saturated output power, 27% power-added efficiency and 35 dB of small signal gain at mid band.

The TGA2579-2-FL features low loss ground-signal-ground (GSG) RF transitions designed to interface with a coplanar waveguide multilayer board.

Ideally suited for Ku-band communications, the TGA2579-2-FL supports key commercial and defense-related frequency bands.

TriQuint's 0.25um GaN on SiC process offers superior electrical performance while maintaining high reliability. In addition, the use of SiC substrates provides optimum thermal performance necessary for reliable high power operation.

Lead-free and RoHS compliant.

Pad Configuration

Pad No.	Symbol
1, 7, 8, 14	V_D
2, 6	V_G
3, 5, 10, 12	GND
4	RF IN
9	Voltage Detector
11	RF OUT
13	N/C

Ordering Information

Part	ECCN	Description
TGA2579-2-FL	3A001.b.2.b	GaN Power Amplifier

Absolute Maximum Ratings

Parameter	Value
Drain Voltage (V_D)	40 V
Drain to Gate Voltage (V_D-V_G)	100 V
Gate Voltage Range (V_G)	-5 to 0 V
Drain Current (I_D)	4.3 A
Gate Current (I_G)	-16 to 84 mA
Power Dissipation (P_{DISS})	131 W
RF Input Power, CW, 50 Ω , T = 25 °C (P_{IN})	29 dBm
Channel Temperature (T_{CH})	275 °C
Mounting Temperature (30 Seconds)	260 °C
Storage Temperature	-40 to 150 °C

Operation of this device outside the parameter ranges given above may cause permanent damage. These are stress ratings only, and functional operation of the device at these conditions is not implied.

Recommended Operating Conditions

Parameter	Value
Drain Voltage (V_D)	25 V
Drain Current (I_{DQ})	1000 mA
Drain Current Under RF Drive (I_{D_Drive})	2900 mA
Gate Voltage (V_G)	-2.4 V (Typ.)

Electrical specifications are measured at specified test conditions. Specifications are not guaranteed over all recommended operating conditions.

Electrical Specifications

Test conditions unless otherwise noted: 25 °C, $V_D = 25$ V, $I_{DQ} = 1000$ mA, $V_G = -2.4$ V Typical, CW.

Parameter	Min	Typical	Max	Units
Operational Frequency Range	14.0		15.35	GHz
Small Signal Gain @ Mid Band		35		dB
Input Return Loss		8		dB
Output Return Loss		7		dB
Gain @ Pin = 0dBm		34		dB
Output Power at Saturation (Pin = 24dBm)		43		dBm
Power-Added Efficiency (Pin = 24dBm)		27		%
Output TOI		44		dBm
Gain Temperature Coefficient		-0.05		dB/°C
Power Temperature Coefficient		-0.004		dBm/°C

Thermal and Reliability Information

Parameter	Test Conditions	Value	Units
Thermal Resistance, $\theta_{JC(1)}$	Tbaseplate = 85 °C	1.5	°C/W
Channel Temperature, T_{CH} (Under RF Drive)	Tbaseplate = 85 °C, $V_D = 25 V$, $I_{D_Drive} = 2900 mA$, $P_{OUT} = 43.0 dBm$, $P_{DISS} = 53 W$	162	°C
Median Lifetime, T_M (Under RF Drive)		4.85×10^8	Hrs
Channel Temperature, T_{CH} (Under RF Drive)	Tbaseplate = 85 °C, $V_D = 30 V$, $I_{D_Drive} = 3060 mA$, $P_{OUT} = 44.0 dBm$, $P_{DISS} = 66 W$	180	°C
Median Lifetime, T_M (Under RF Drive)		7.99×10^7	Hrs

Notes: (1) Thermal resistance measured at back of the package.

Median Lifetime

Test Conditions: $V_D = 40V$; Failure Criteria is 10% reduction in I_{D_MAX}

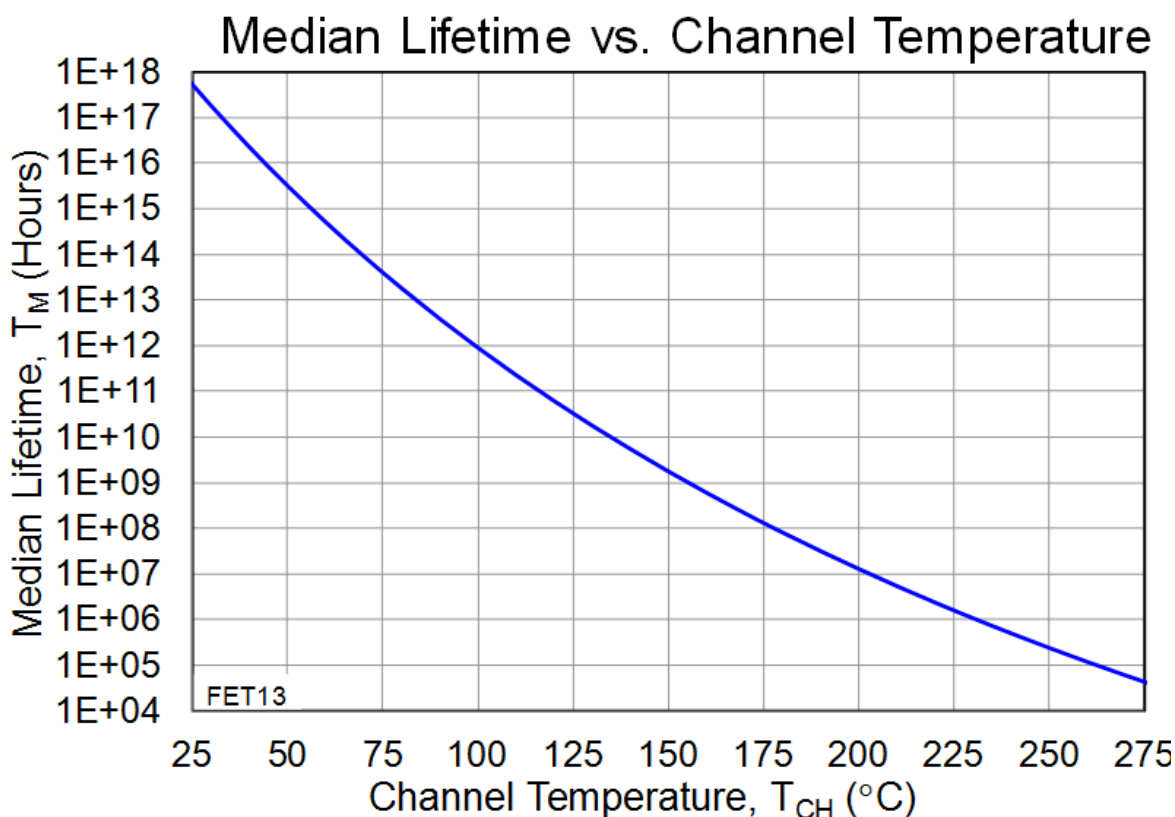

Typical Performance

Conditions unless otherwise specified: $V_D = 25\text{ V}$, $I_{DQ} = 1.0\text{ A}$, $V_G = -2.4\text{ V}$ Typical, CW

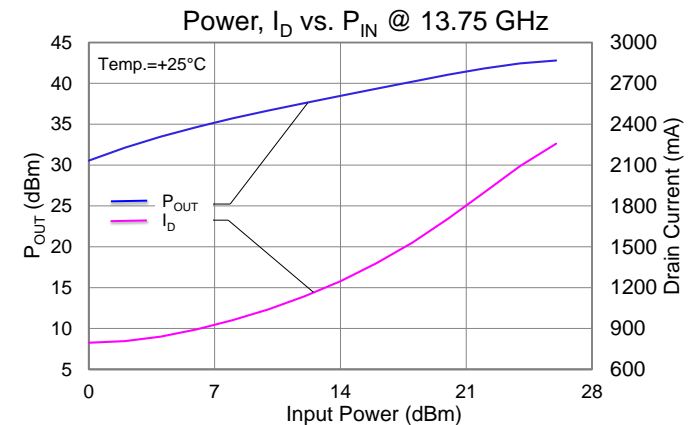
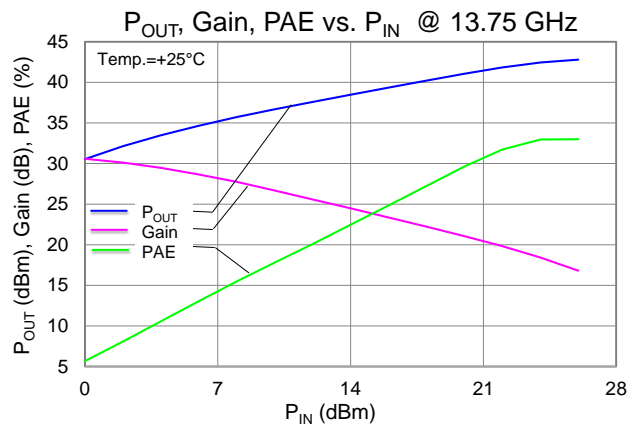
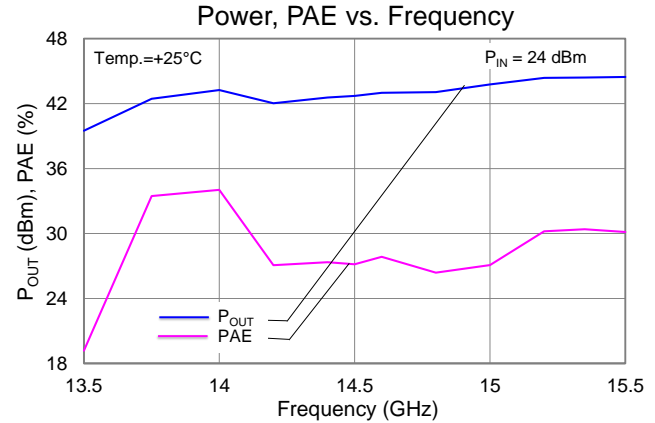
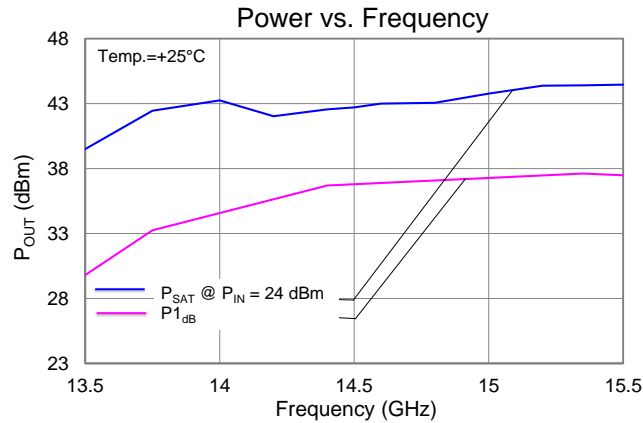
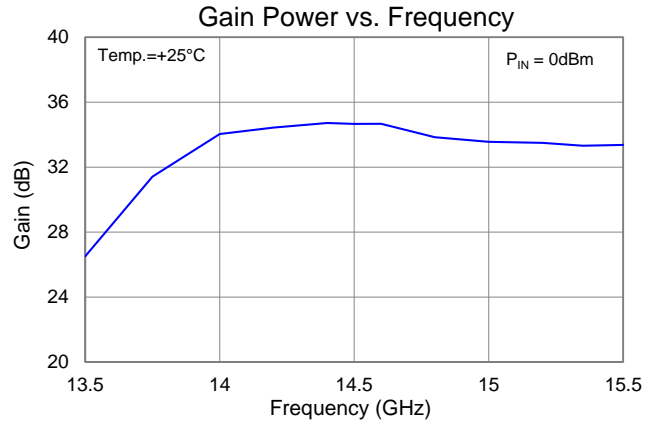
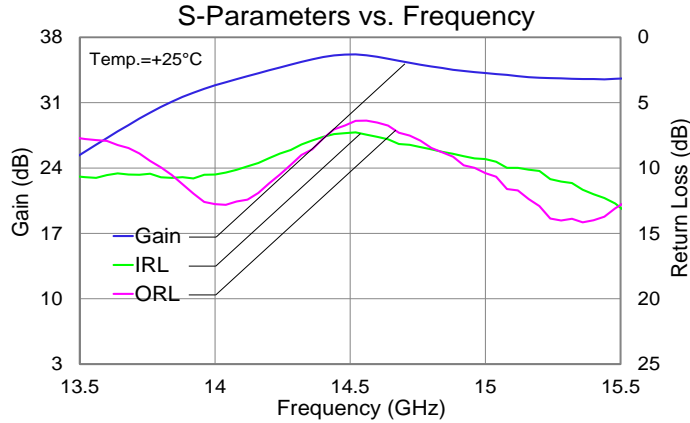

Typical Performance

Conditions unless otherwise specified: $V_D = 25\text{ V}$, $I_{DQ} = 1.0\text{ A}$, $V_G = -2.4\text{ V}$ Typical, CW

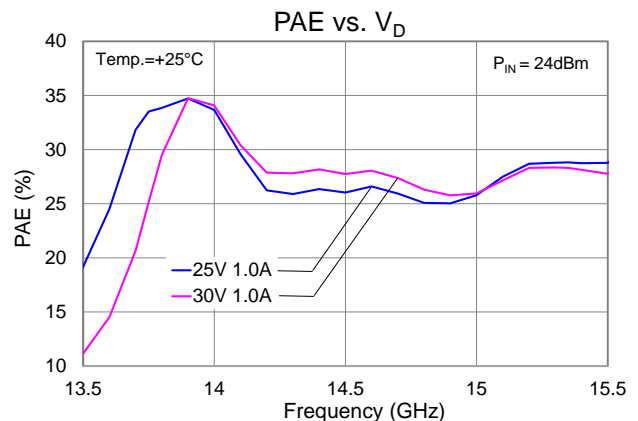
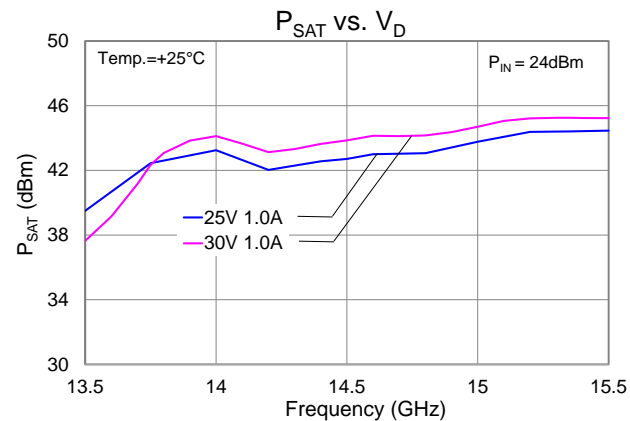
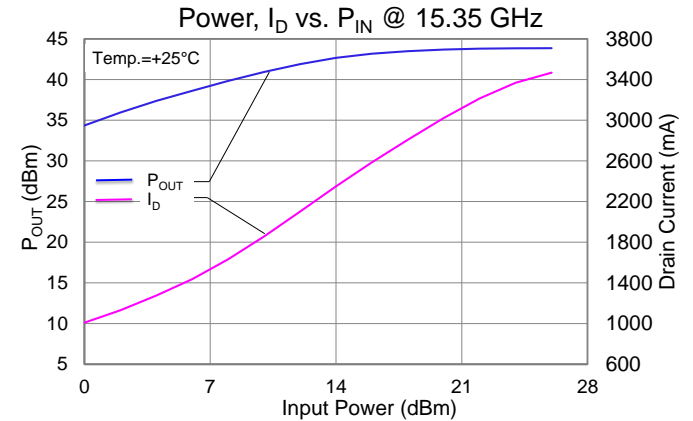
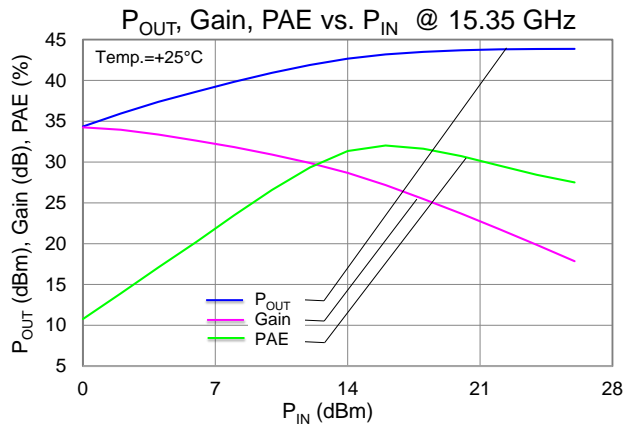
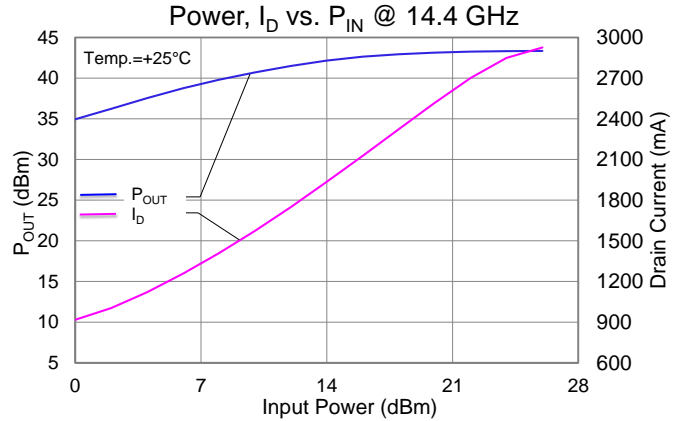
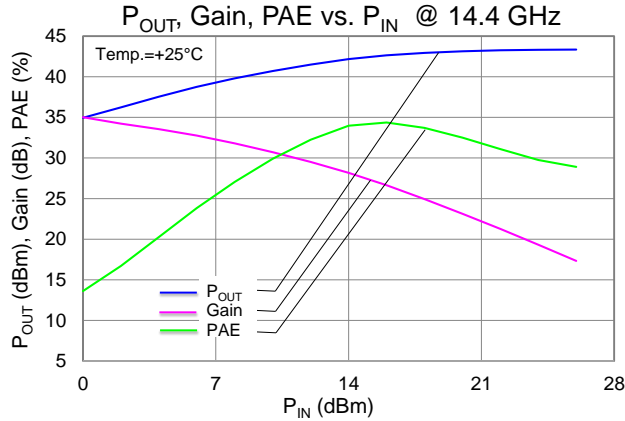

Typical Performance

Conditions unless otherwise specified: $V_D = 25\text{ V}$, $I_{DQ} = 1.0\text{ A}$, $V_G = -2.4\text{ V}$ Typical, CW

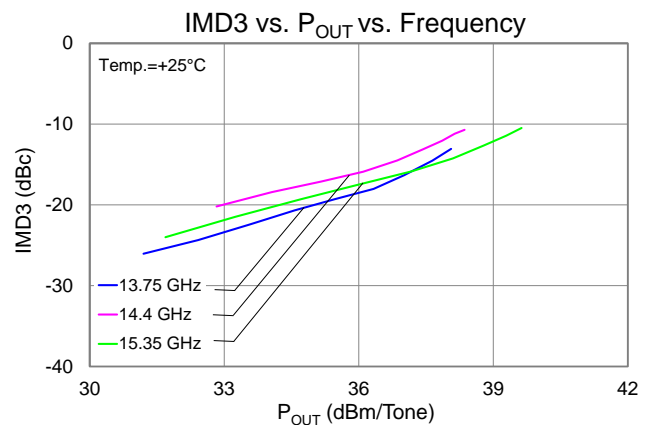
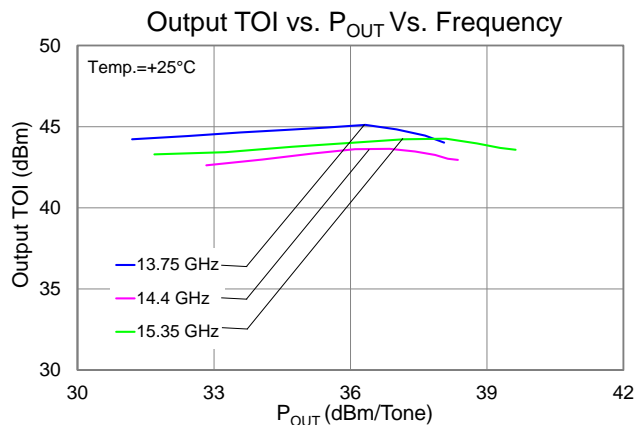
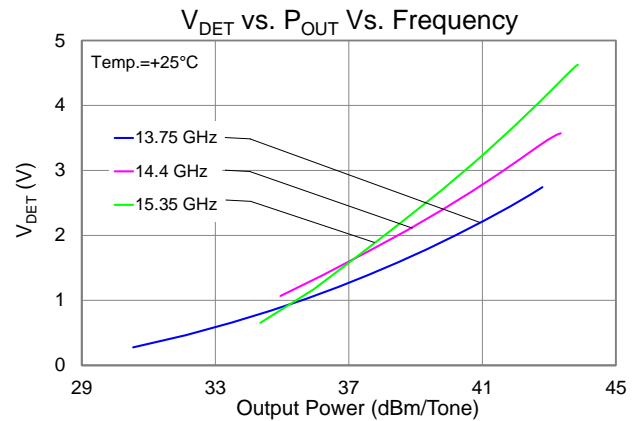
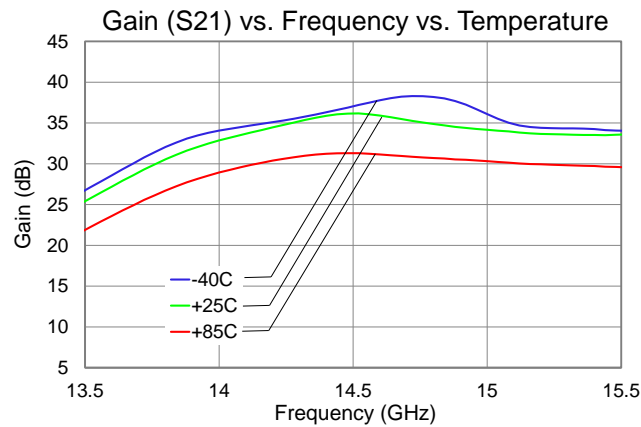
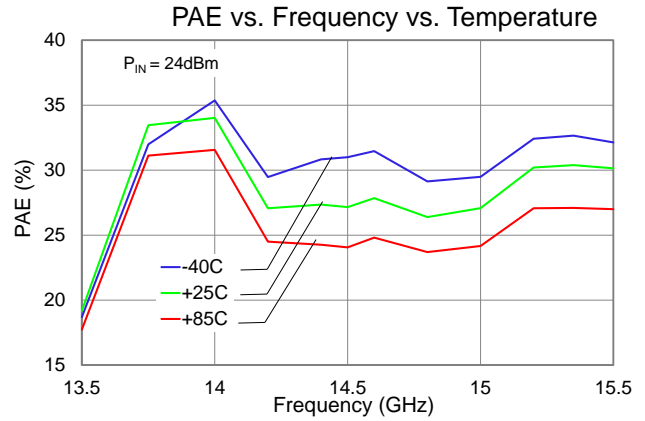
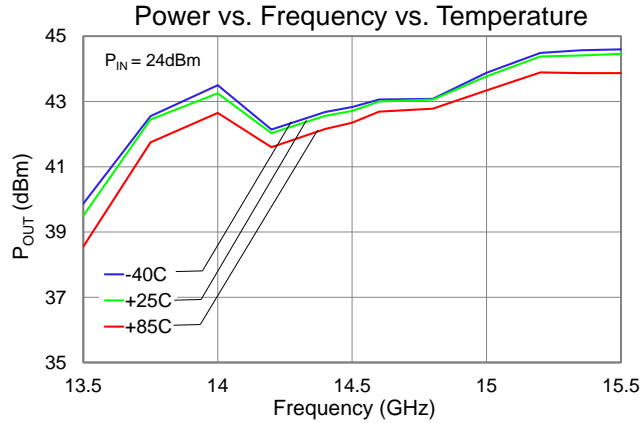

Application Circuit

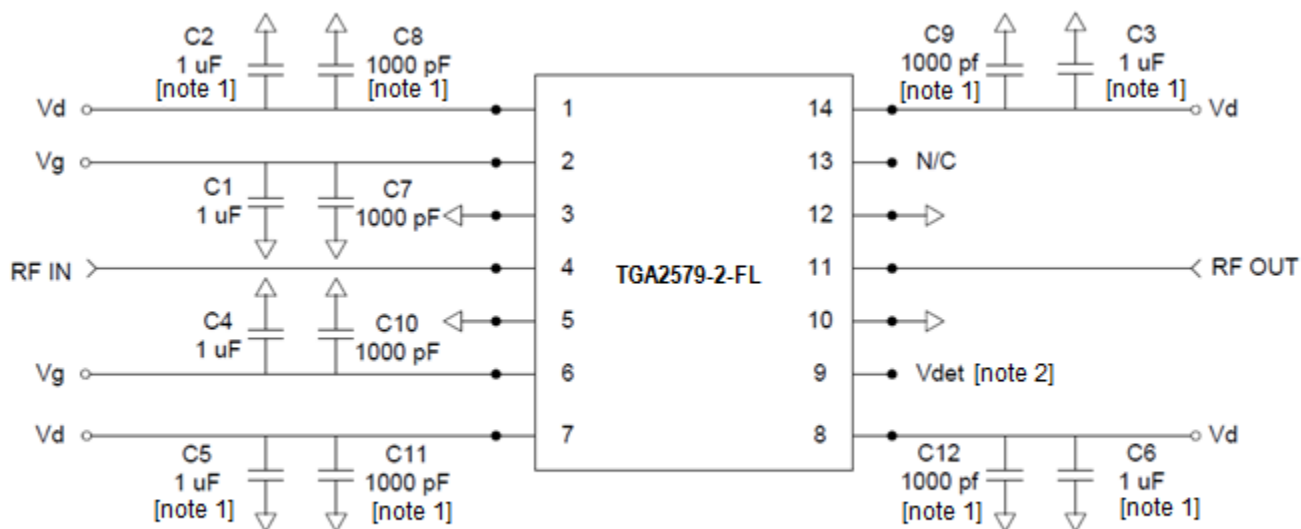

Note 1: Remove cap for pulsed drain operation

Note 2: No external load resistor or capacitor is required

Notes: To prevent damage to the device due to overshoot or oscillation issues, we recommend that current limits for all power supplies are set properly for each power supply before applying the voltage. The following are recommended current limits for each power supply:

Set 60 mA current limit to V_G

Set 4A current limit to V_D

Bias-up Procedure

1. Apply -5.0 V to V_G
2. Apply +25 V to V_D .
3. Adjust V_G until $I_{DQ} = 1000$ mA ($V_G \sim -2.4$ V Typ.)
4. Turn on RF supply.

Bias-down Procedure

1. Turn off RF supply.
2. Reduce V_G to -5.0 V. Ensure $I_{DQ} \sim 0$ mA
3. Set V_D to 0 V.
4. Set V_G to 0 V.

Evaluation Board Layout

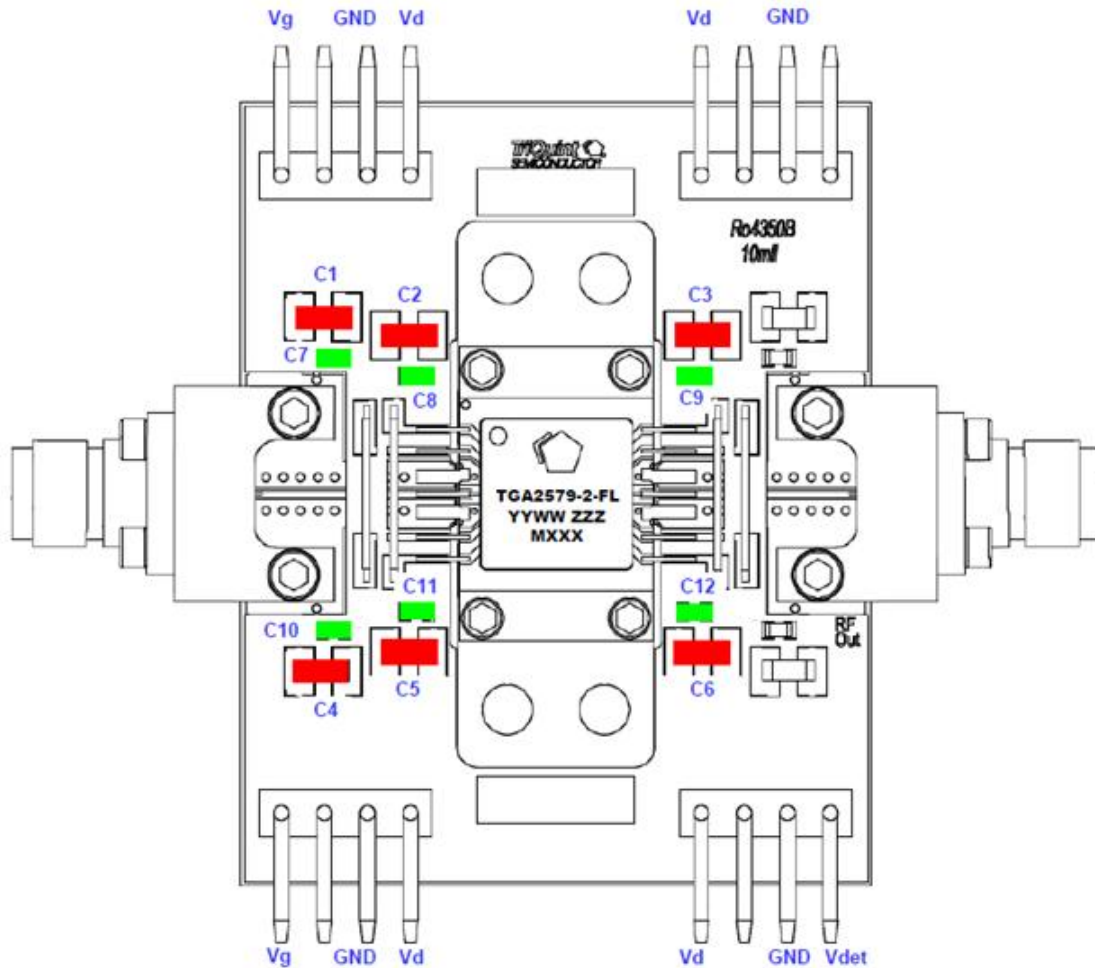

Bill of Materials

Reference Design	Value	Description	Manufacturer	Part Number
C1 – C6	1.0 uF	Cap, 1206, 50V, 10%, XR7	KEMET	C1206C105K5RACTU
C7 – C12	0.1 uF	Cap, 0603, 50V, 10%, XR7	KEMET	C0603C104K5RACTU

Pin Layout

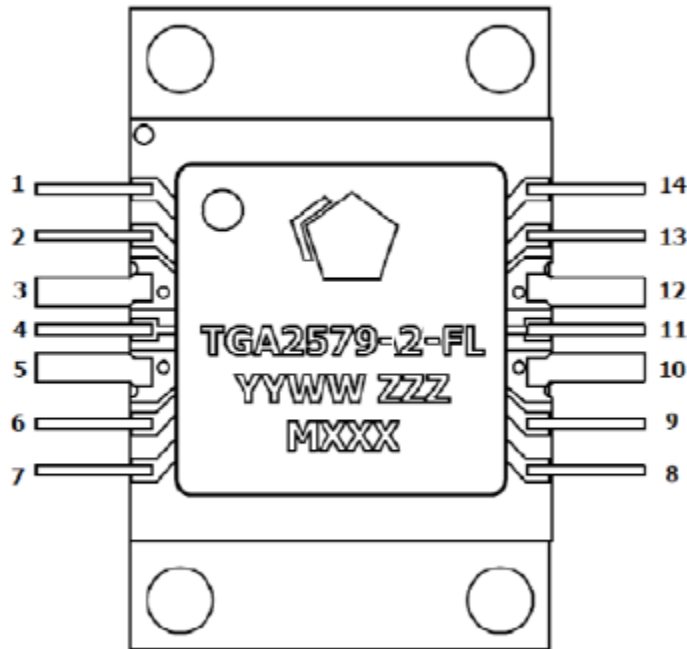

Pin Description

Pin	Symbol	Description
1, 7, 8, 14	V_D	Drain voltage. Bias network is required; must be biased from each pin; see Application Circuit on page 7 as an example.
2, 6	V_G	Gate voltage. Bias network is required; must be biased from both sides; see Application Circuit on page 7 as an example.
3, 5, 10, 12	GND	Connect to Ground; see Application Circuit on page 7 as an example..
4	RF IN	RF input.
9	V_{DET}	Voltage detector; see Application Circuit on page 7 as an example.
11	RF OUT	RF output.
13	N/C	No internal connection; can be left open or grounded.

Mechanical Information

All dimensions are in millimeter (mm). Unless specified otherwise.

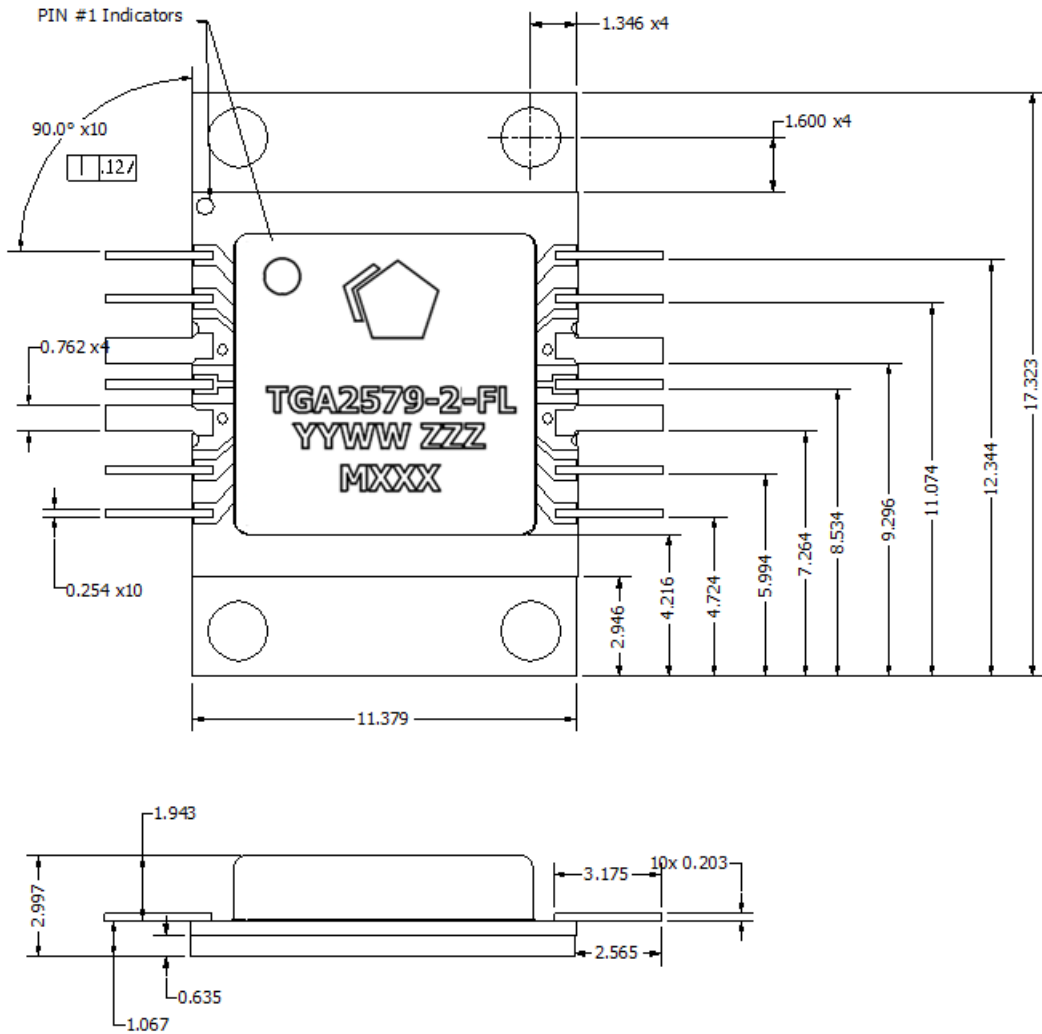

Marking: Part number – TGA2579-2-FL
 Year/Weak code – WWYY
 Serial Number - ZZZZ
 Batch ID – MXXX

Assembly Notes

1. Clean the board or module with alcohol. Allow it to dry fully.
2. Nylock screws are recommended for mounting the TGA2579-2-FL to the board.
3. To improve the thermal and RF performance, we recommend a heat sink attached to the bottom of the board and apply thermal compound or 4 mils Indium shim between the heat sink and the TGA2579-2-FL base.
4. Apply solder to each pin of the TGA2579-2-FL.
5. Clean the assembly with alcohol.

Product Compliance Information**ESD Sensitivity Ratings**

Caution! ESD-Sensitive Device

ESD Rating: Class 1B
Value: 500 V
Test: Human Body Model (HBM)
Standard: JEDEC Standard JESD22-A114

MSL Rating

Level 3 at +260°C convection reflow
The part is rated Moisture Sensitivity Level 3 at 260°C per
JEDEC standard IPC/JEDEC J-STD-020

ECCN

US Department of Commerce: 3A001.b.2.b

RoHS Compliance

This part is compliant with EU 2002/95/EC RoHS directive (Restrictions on the Use of Certain Hazardous Substances in Electrical and Electronic Equipment).

This product also has the following attributes:

- Lead Free
- Halogen Free (Chlorine, Bromine)
- Antimony Free
- TBBP-A (C₁₅H₁₂Br₄O₂) Free
- PFOS Free
- SVHC Free

Contact Information

For the latest specifications, additional product information, worldwide sales and distribution locations, and information about TriQuint:

Web: www.triquint.com
Email: info-sales@triquint.com

Tel: +1.972.994.8465
Fax: +1.972.994.8504

For technical questions and application information: Email: info-products@triquint.com

Important Notice

The information contained herein is believed to be reliable. TriQuint makes no warranties regarding the information contained herein. TriQuint assumes no responsibility or liability whatsoever for any of the information contained herein. TriQuint assumes no responsibility or liability whatsoever for the use of the information contained herein. The information contained herein is provided "AS IS, WHERE IS" and with all faults, and the entire risk associated with such information is entirely with the user. All information contained herein is subject to change without notice. Customers should obtain and verify the latest relevant information before placing orders for TriQuint products. The information contained herein or any use of such information does not grant, explicitly or implicitly, to any party any patent rights, licenses, or any other intellectual property rights, whether with regard to such information itself or anything described by such information.

TriQuint products are not warranted or authorized for use as critical components in medical, life-saving, or life-sustaining applications, or other applications where a failure would reasonably be expected to cause severe personal injury or death.