

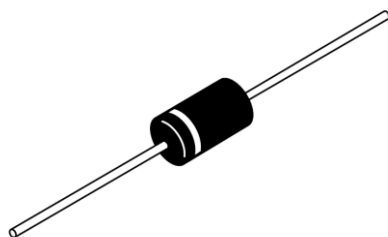

**RoHS**  
 COMPLIANT



**DO-204AR**

**DESCRIPTION**

The **50SQXXX** axial leaded Schottky rectifier series has been optimized for low reverse leakage at high temperature. The proprietary barrier technology allows for reliable operation up to 175 °C junction temperature. Typical applications are in switching power supplies, converters, freewheeling diodes, and reverse battery protection.

**FEATURES**

- 175 °C T<sub>J</sub> operation
- Low forward voltage drop
- High frequency operation
- High purity, high temperature epoxy encapsulation for enhanced mechanical strength and moisture resistance
- Guard ring for enhanced ruggedness and long term reliability
- Designed and qualified for commercial level

<b>PRODUCT SUMMARY</b>	
Package	DO-204AR
I <sub>F(AV)</sub>	5 A
V <sub>R</sub>	60 V, 80 V, 100 V
V <sub>F</sub> at I <sub>F</sub>	0.52 V
I <sub>RM</sub> max.	7.0 mA at 125 °C
T <sub>J</sub> max.	175 °C
Diode variation	Single die
E <sub>AS</sub>	7.5 mJ

<b>MAJOR RATINGS AND CHARACTERISTICS</b>			
SYMBOL	CHARACTERISTICS	VALUES	UNITS
I <sub>F(AV)</sub>	Rectangular waveform	5	A
V <sub>RRM</sub>	Range	60 to 100	V
I <sub>FSM</sub>	t <sub>p</sub> = 5 μs sine	1900	A
V <sub>F</sub>	5 Apk, T <sub>J</sub> = 125 °C	0.52	V
T <sub>J</sub>	Range	- 55 to 175	°C

<b>VOLTAGE RATINGS</b>					
PARAMETER	SYMBOL	50SQ060	50SQ080	50SQ100 50SQ100-M3	UNITS
Maximum DC reverse voltage	V <sub>R</sub>	60	80	100	V
Maximum working peak reverse voltage	V <sub>RWM</sub>				

<b>ABSOLUTE MAXIMUM RATINGS</b>					
PARAMETER	SYMBOL	TEST CONDITIONS		VALUES	UNITS
Maximum average forward current See fig. 5	I <sub>F(AV)</sub>	50 % duty cycle at T <sub>C</sub> = 119 °C, rectangular waveform		5	A
Maximum peak one cycle non-repetitive surge current See fig. 7	I <sub>FSM</sub>	5 μs sine or 3 μs rect. pulse	Following any rated load condition and with rated V <sub>RRM</sub> applied	1900	
		10 ms sine or 6 ms rect. pulse		290	
Non-repetitive avalanche energy	E <sub>AS</sub>	T <sub>J</sub> = 25 °C, I <sub>AS</sub> = 1.0 A, L = 15 mH		7.5	mJ
Repetitive avalanche current	I <sub>AR</sub>	Current decaying linearly to zero in 1 μs Frequency limited by, T <sub>J</sub> maximum V <sub>A</sub> = 1.5 x V <sub>R</sub> typical		1.0	A



ELECTRICAL SPECIFICATIONS					
PARAMETER	SYMBOL	TEST CONDITIONS		VALUES	UNITS
Maximum forward voltage drop See fig. 1	$V_{FM}^{(1)}$	5 A	$T_J = 25\text{ }^\circ\text{C}$	0.66	V
		10 A		0.77	
		5 A	$T_J = 125\text{ }^\circ\text{C}$	0.52	
		10 A		0.62	
Maximum reverse leakage current See fig. 2	$I_{RM}^{(1)}$	$T_J = 25\text{ }^\circ\text{C}$	$V_R = \text{Rated } V_R$	0.55	mA
		$T_J = 125\text{ }^\circ\text{C}$		7	
Maximum junction capacitance	$C_T$	$V_R = 5\text{ }V_{DC}$ , (test signal range 100 kHz to 1 MHz), $25\text{ }^\circ\text{C}$		500	pF
Typical series inductance	$L_S$	Measured lead to lead 5 mm from body		10	nH
Maximum voltage rate of change	dV/dt	Rated $V_R$		10 000	V/ $\mu\text{s}$

**Note**

(1) Pulse width < 300  $\mu\text{s}$ , duty cycle < 2 %

THERMAL - MECHANICAL SPECIFICATIONS					
PARAMETER	SYMBOL	TEST CONDITIONS		VALUES	UNITS
Maximum junction and storage temperature range	$T_J, T_{Stg}$			- 55 to 175	$^\circ\text{C}$
Maximum thermal resistance, junction to lead	$R_{thJL}$	DC operation; see fig. 4 1/8" lead length		8.0	$^\circ\text{C/W}$
Typical thermal resistance, junction to air	$R_{thJA}$			44	
Approximate weight				1.4	g
				0.049	oz.
Marking device		Case style DO-204AR (JEDEC)		50SQ060	
				50SQ080	
				50SQ100	

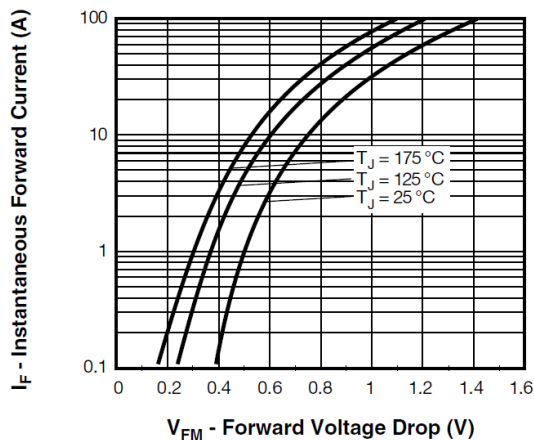

Fig. 1 - Maximum Forward Voltage Drop Characteristics

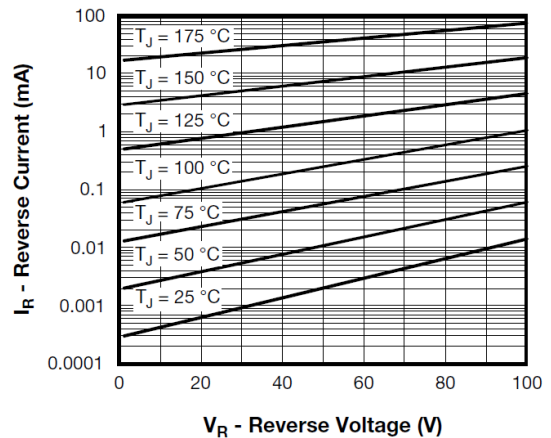

Fig. 2 - Typical Values of Reverse Current vs. Reverse Voltage



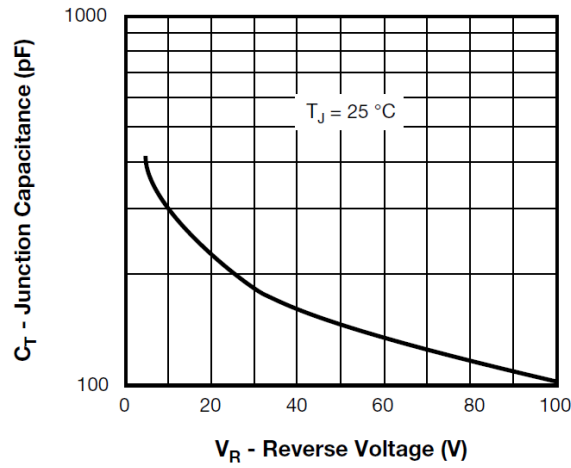

Fig. 3 - Typical Junction Capacitance vs. Reverse Voltage

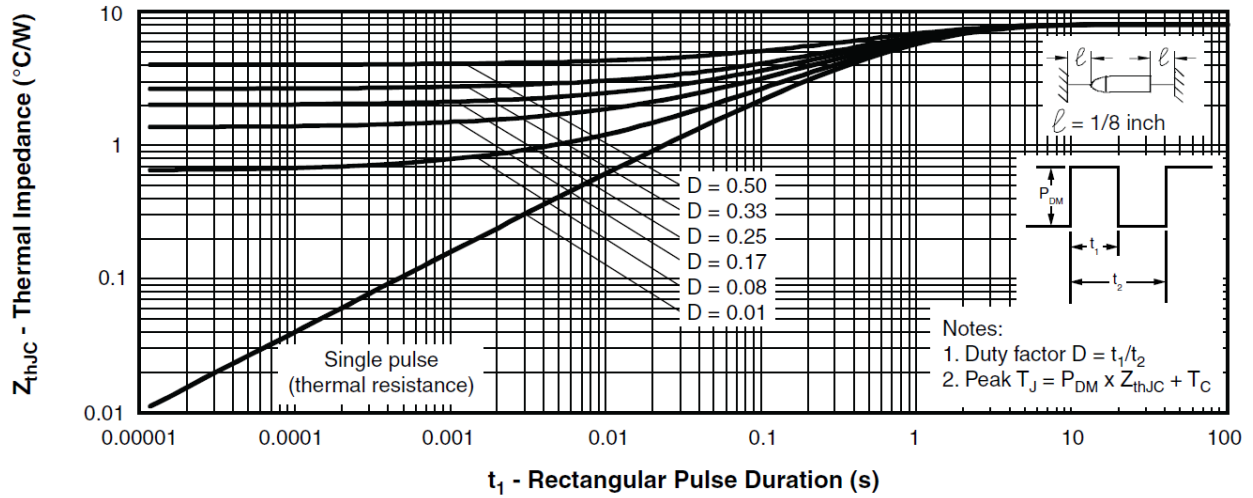

Fig. 4 - Maximum Thermal Impedance  $Z_{thJL}$  Characteristics

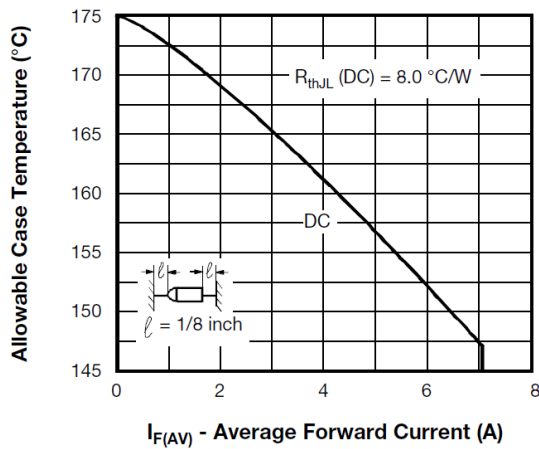

Fig. 5 - Maximum Allowable Case Temperature vs. Average Forward Current

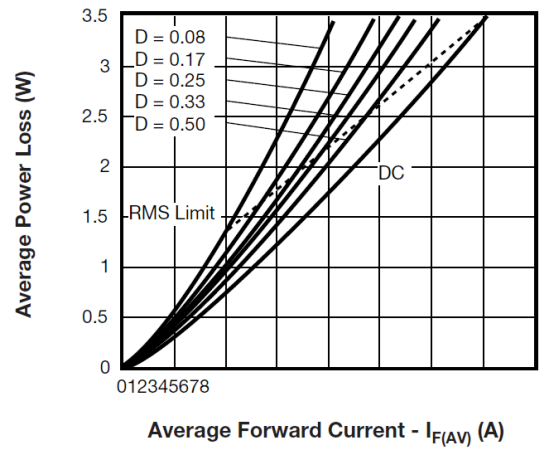

Fig. 6 - Forward Power Loss Characteristics



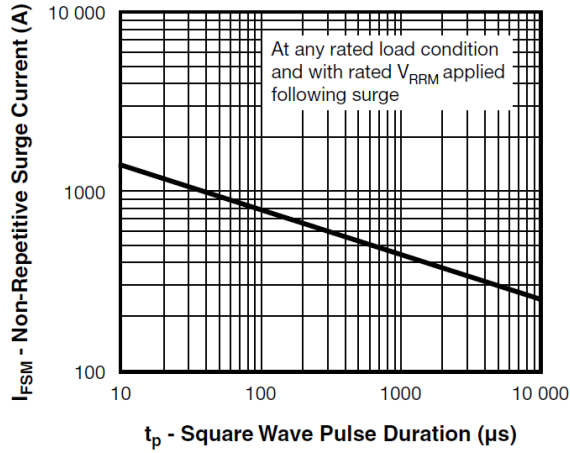

Fig. 7 - Maximum Non-Repetitive Surge Current

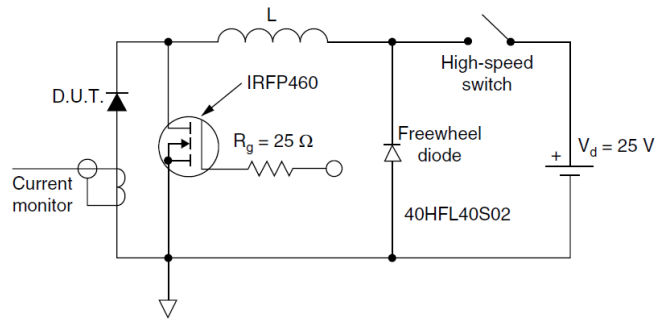

Fig. 8 - Unclamped Inductive Test Circuit

## Axial DO-204AR

**DIMENSIONS** in millimeters (inches)

