

RT4-D10D3WR

SMD - DIP 10 Package

- Miniature SMD package
- Operating temperature range: -40°C to +105°C
- High efficiency up to 82%
- Isolation voltage: 3KVDC
- Internal surface mounted design
- No external component required
- International standard pin-out
- Continuous Short Circuit Protection

RoHS



RT4-series are specially designed for applications where an isolated voltage is required in a distributed power supply system. They are suitable for

1. Where the voltage of the input power supply is stable (voltage variation: $\pm 10\%V_{in}$);
2. Where isolation between input and output is necessary (isolation voltage $\leq 3000VDC$);
3. Where the output voltage regulation is not strictly required;
4. Typical application: preceding-stage interference isolation condition; ground-interference canceled condition; digit circuit condition; Voltage-isolation converting condition; normal low-frequency artificial circuit condition; relay drive circuit condition, etc.

Selection Guide

Part No.	Input Voltage (VDC)	Output		Efficiency (%/Min./Typ.) @ Full Load	Max. Capacitive Load (μF)
	Nominal (Range)	Output Voltage (VDC)	Output Current (mA) (Max./Min.)		
RT4-0305D10D3WR	3.3 (2.97-3.63)	± 5	$\pm 100/\pm 10$	72/76	100
RT4-0312D10D3WR		± 12	$\pm 42/\pm 5$	73/77	
RT4-0505D10D3WR	5 (4.5-5.5)	± 5	$\pm 100/\pm 10$	76/80	
RT4-0509D10D3WR		± 9	$\pm 56/\pm 6$	76/80	
RT4-0512D10D3WR		± 12	$\pm 42/\pm 5$	75/79	
RT4-0515D10D3WR		± 15	$\pm 33/\pm 3$	77/81	
RT4-0524D10D3WR		± 24	$\pm 21/\pm 2$	77/81	
RT4-1205D10D3WR	12 (10.8-13.2)	± 5	$\pm 100/\pm 10$	76/80	
RT4-1209D10D3WR		± 9	$\pm 56/\pm 6$	76/80	
RT4-1212D10D3WR		± 12	$\pm 42/\pm 5$	77/81	
RT4-1215D10D3WR		± 15	$\pm 33/\pm 3$	77/81	
RT4-1224D10D3WR		± 24	$\pm 21/\pm 2$	77/81	
RT4-1515D10D3WR	15 (13.5-16.5)	± 15	$\pm 33/\pm 3$	77/81	
RT4-2405D10D3WR	24 (21.6-26.4)	± 5	$\pm 100/\pm 10$	76/80	
RT4-2409D10D3WR		± 9	$\pm 56/\pm 6$	76/80	
RT4-2412D10D3WR		± 12	$\pm 42/\pm 5$	77/81	
RT4-2415D10D3WR		± 15	$\pm 33/\pm 3$	78/82	
RT4-2424D10D3WR		± 24	$\pm 21/\pm 2$	72/76	

Note: *The capacitive loads of positive and negative outputs are identical.

RT4-D10D3WR

Input Specifications					
Item	Operating Conditions	Min.	Typ.	Max.	Unit
Input Current (full load / no-load)	3.3V input	--	389/25	--/70	mA
	5V input	--	250/20	--/60	
	12V input	--	104/15	--/50	
	15V input	--	83/12	--/35	
	24V input	--	52/10	--/30	
Reflected Ripple Current		--	15	--	mA
Surge Voltage (1sec. max.)	3.3V input	-0.7	--	5	VDC
	5V input	-0.7	--	9	
	12V input	-0.7	--	18	
	15V input	-0.7	--	21	
	24V input	-0.7	--	30	
Input Filter		Filter capacitor			
Hot Plug		Unavailable			

Output Specifications						
Item	Operating Conditions	Min.	Typ.	Max.	Unit	
Output Voltage Accuracy		See tolerance envelope curve(Fig. 1)				
Line Regulation	Input voltage change: $\pm 1\%$	--	--	± 1.2	--	
Load Regulation	10%-100% load	5VDC output	--	12	--	%
		9VDC output	--	9	--	
		12VDC output	--	8	--	
		15VDC output	--	7	--	
		24VDC output	--	6	--	
Ripple & Noise*	20MHz bandwidth	--	60	150	mVp-p	
Temperature Coefficient	Full load	--	--	± 0.03	%/°C	
Short Circuit Protection**	RT4-xxD10D3WR/RT4-0524D10D3WR	--	--	1	s	
	Others	Continuous, self-recovery				

Note: * Ripple and noise are measured by parallel cable method, please see DC-DC Converter Application Notes for specific operation;
**Supply voltage must be discontinued at the end of short circuit duration for RT4-0524D10D3WR model and RT4-24xxD10D3WR series.

General Specifications					
Item	Operating Conditions	Min.	Typ.	Max.	Unit
Isolation Voltage	Input-output, with the test time of 1 minute and the leak current lower than 1mA	3000	--	--	VDC
Isolation Resistance	Input-output, isolation voltage 500VDC	1000	--	--	M Ω
Isolation Capacitance	Input-output, 100KHz/0.1V	--	20	--	pF
Operating Temperature	Derating when operating temperature up to 100°C, (see Fig. 2)	-40	--	105	°C
Storage Temperature		-55	--	125	
Casing Temperature Rise	Ta=25°C, nominal input, full load output	--	25	--	
Pin Welding Resistance Temperature	Welding spot is 1.5mm away from the casing, 10 seconds	--	--	300	
Storage Humidity	Non-condensing	--	--	95	%RH
Reflow Soldering Temperature		Peak temp. $\leq 245^\circ\text{C}$, maximum duration time $\leq 60\text{s}$ at 217°C . For actual application, please refer to IPC/JEDEC J-STD-020D.1.			
Switching Frequency	Full load, nominal input voltage	--	100	--	KHz
MTBF	MIL-HDFK-217F@25°C	3500	--	--	K hours

RT4-D10D3WR

Physical Specifications

Casing Material	Black flame-retardant heat-proof epoxy resin (UL94-V0)
Dimensions	15.24*11.20*7.25 mm
Weight	2.0g (Typ.)
Cooling Method	Free convection

EMC Specifications

EMI	RE	CISPR22/EN55022 CLASS B (see Fig. 4 for recommended circuit)
EMS	ESD	IEC/EN61000-4-2 Contact $\pm 6KV$ perf. Criteria B

Product Characteristic Curve

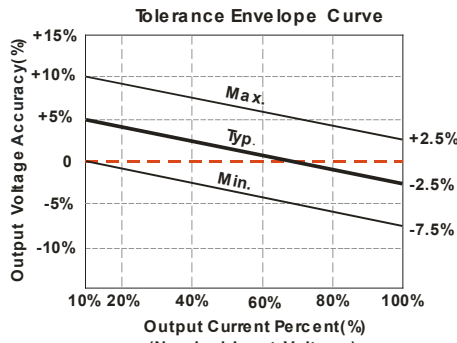

Fig. 1

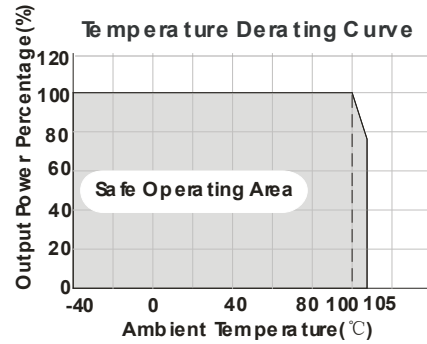
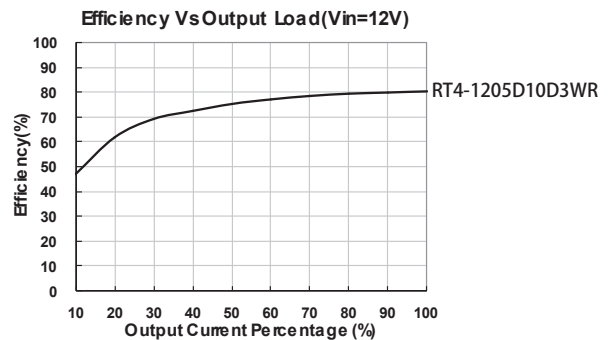
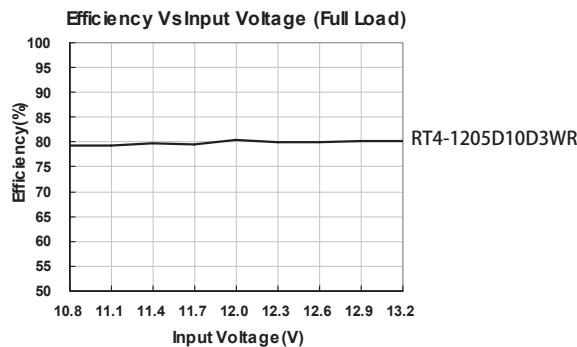
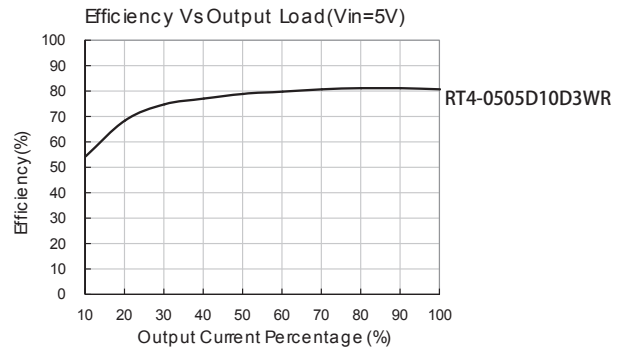
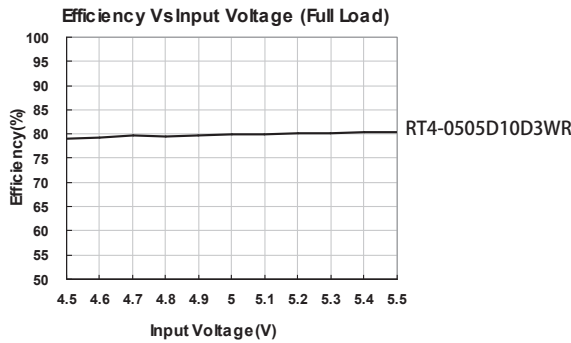

Fig. 2



Design Reference

1. Typical application circuit

If it is required to further reduce input and output ripple, a filter capacitor may be connected to the input and output terminals, see Fig.3. Moreover, choosing a suitable filter capacitor is very important, start-up problems may be caused if the capacitance is too large. Under the condition of safe and reliable operation, the recommended capacitive load values are shown in Table 1.

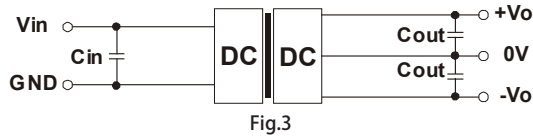

Recommended capacitive load value table (Table 1)

Vin(VDC)	Cin(μ F)	Vo (VDC)	Cout(μ F)
3.3	4.7	± 5	4.7
5	4.7	± 9	2.2
12	2.2	± 12	1
15	2.2	± 15	1
24	1	± 24	0.47

2. EMC solution-recommended circuit

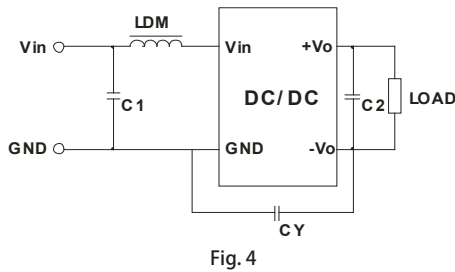

Input voltage (VDC)		3.3/5/12	15/24
EMI	C1	4.7 μ F /50V	
	C2	Refer to the Cout in Fig.3	
	LDM	6.8 μ H	
	CY	--	1nF /3KV

Note: 1. 24V input series, 24V output series is subject to CY (CY : 1nF/3KV).

2. It is not needed to add the component in the peripheral circuit when parameter with the symbol of "--".

3. Output load requirements

When using, the minimum load of the module output should not be less than 10% of the nominal load. In order to meet the performance parameters of this datasheet, please connect a 10% dummy load in parallel at the output end, the dummy load is generally a resistor, Please note that the resistor needs to be used in derating.

RT4-D10D3WR

Dimensions and Recommended Layout

THIRD ANGLE PROJECTION 

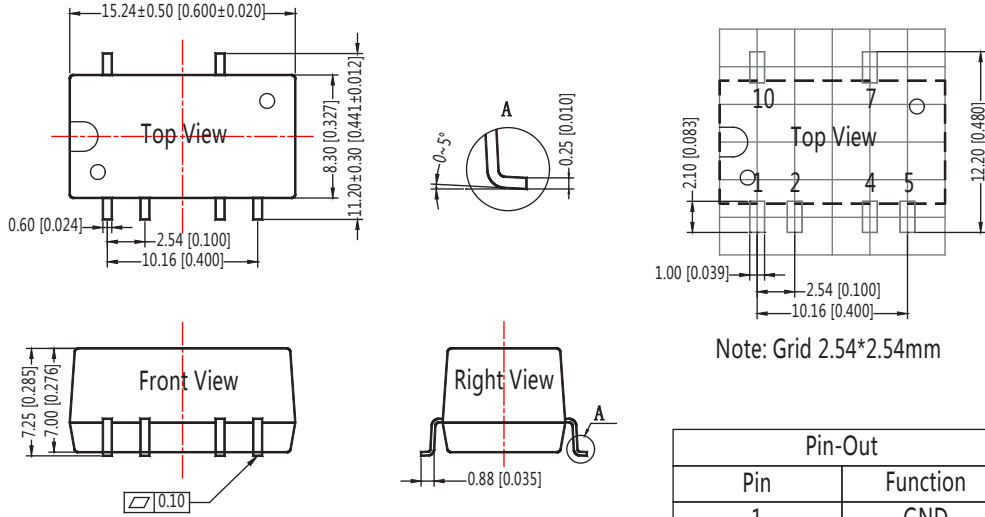

Note: Grid 2.54*2.54mm

Pin-Out	
Pin	Function
1	GND
2	Vin
4	0V
5	-Vo
7	+Vo
10	NC

NC: No Connection

Note:
Unit: mm[inch]
Pin section tolerances: $\pm 0.10[\pm 0.004]$
General tolerances: $\pm 0.25[\pm 0.010]$

If the product is not operated within the required load range, the product performance cannot be guaranteed to comply with all parameters in the datasheet;

The maximum capacitive load offered were tested at nominal input voltage and full load;

Unless otherwise specified, parameters in this datasheet were measured under the conditions of $T_a=25^\circ\text{C}$, humidity<75% with nominal input voltage and rated output load;

All index testing methods in this datasheet are based on our Company's corporate standards;

The performance parameters of the product models listed in this manual are as above, but some parameters of non-standard model products may exceed the requirements mentioned above. Please contact our technicians directly for specific information;

We can provide product customization service;

Specifications are subject to change without prior notice.

The models listed here are just standard type. If you need a product with special specification or you have questions regarding packing standards (Tube oder Tape/Reel) as well as application support, please contact our specialists: sales@rsg-electronic.de or +49 69-984047-41/-28