

STK600-RC032M-91

J3 and J4 mates with the socket card, while J1 and J2 goes down to the mother board. J1 is physical placed below J3, and J2 below J4.

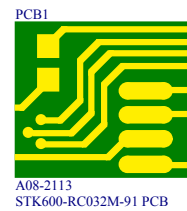

Product number/revision
Serial number
Label PCB A

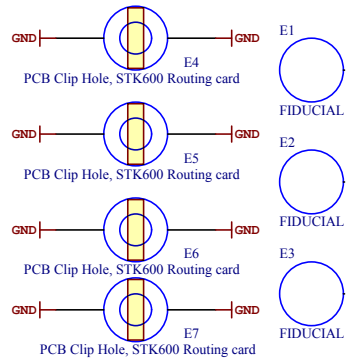
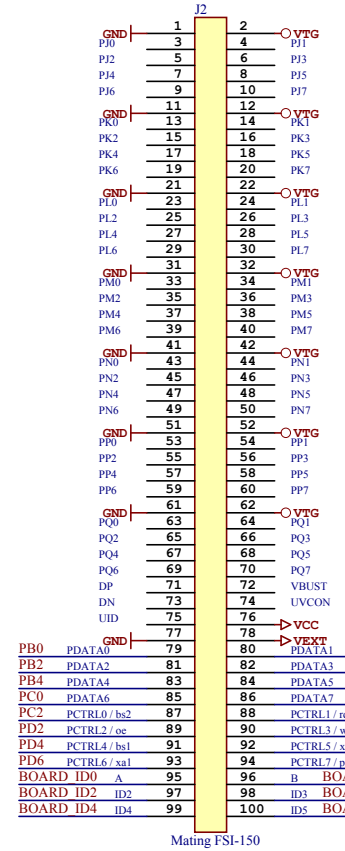
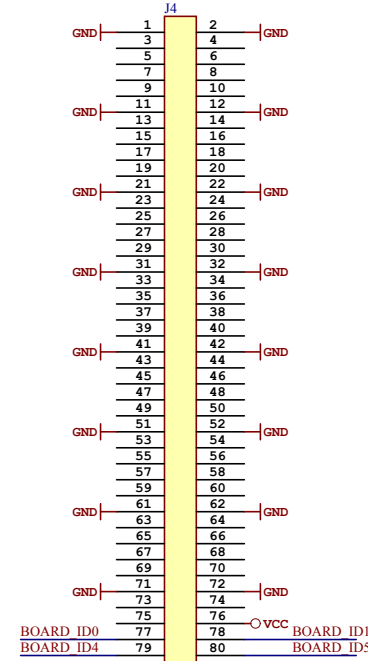
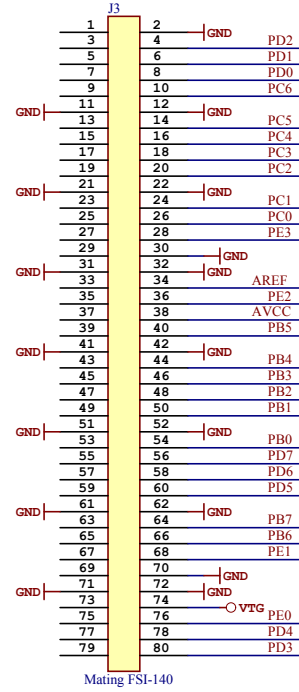
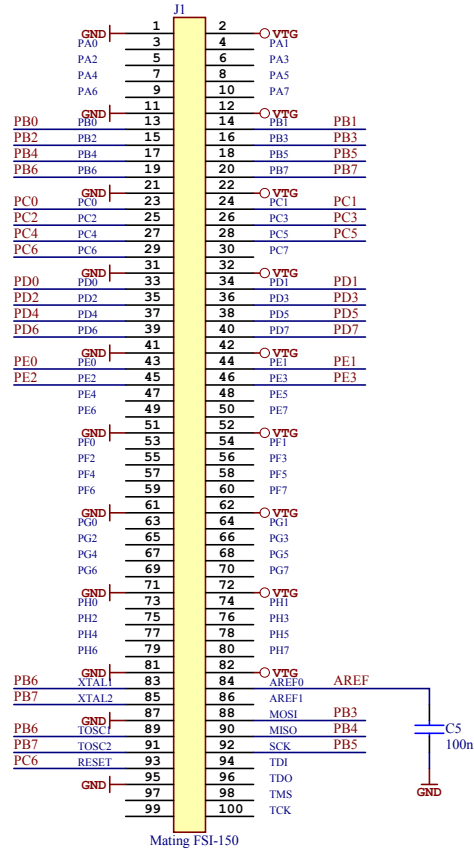
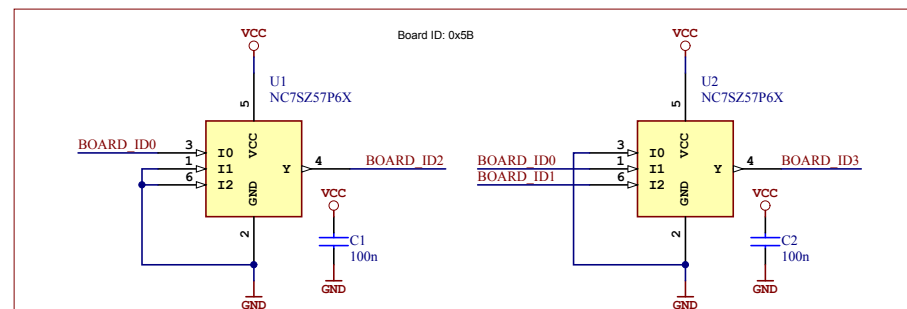

ATMEL Norway	*		
Vestre Rosten 79	*		
N-7075 TILLER	*		
NORWAY			
Date:	20.03.2014	11:59:04	PAGE: 1 of 1
Document number:	*		Revision: 1
TITLE: STK600-RC032M-91			
STK600-RC032M-91.SchDoc			

