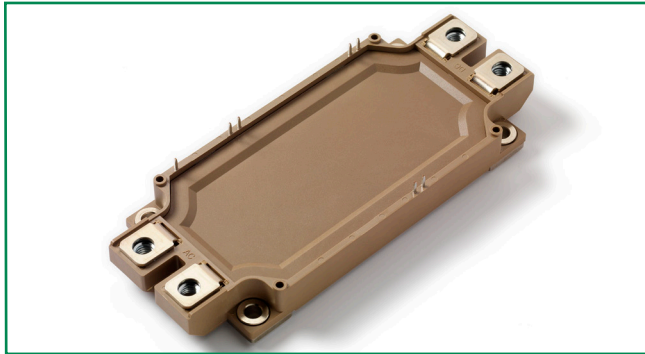

**MG12600WB-BR2MM**

### Features

- Trench-gate field stop IGBT technology
- Low saturation voltage and positive temperature coefficient
- Fast switching and short tail current
- Free wheeling diodes with fast and soft reverse recovery
- Temperature sense included
- $T_{Jmax} = 175\text{ }^{\circ}\text{C}$

### Applications

- Industrial and servo drives
- Solar inverters
- High-power converters
- UPS
- Welding
- RoHS compliant

### Agency Approvals

AGENCY	AGENCY FILE NUMBER
	E71639

### Module Characteristics ( $T_c = 25\text{ }^{\circ}\text{C}$ , unless otherwise specified)

Symbol	Parameters	Test Conditions	Values	Unit
$T_{Jmax}$	Max. Junction Temperature		175	$^{\circ}\text{C}$
$T_{Jop}$	Operating Temperature		-40~150	$^{\circ}\text{C}$
$T_{stg}$	Storage Temperature		-40~125	$^{\circ}\text{C}$
$V_{isol}$	Isolation Breakdown Voltage	AC, 50 Hz(R.M.S), t = 1 minute	3000	V
Torque	to heatsink	Recommended (M5)	2.5~5	N·m
	terminal	Recommended (M6)	3~5	N·m
Weight			350	g

### Absolute Maximum Ratings ( $T_c = 25\text{ }^{\circ}\text{C}$ , unless otherwise specified)

Symbol	Parameters	Test Conditions	Values	Unit
<b>IGBT</b>				
$V_{CES}$	Collector Emitter Voltage	$T_J = 25\text{ }^{\circ}\text{C}$	1200	V
$V_{GES}$	Gate Emitter Voltage		$\pm 20$	V
$I_C$	DC Collector Current	$T_c = 25\text{ }^{\circ}\text{C}$	750	A
		$T_c = 80\text{ }^{\circ}\text{C}$	600	A
$I_{CM}$	Repetitive Peak Collector Current	$t_p = 1\text{ ms}$	1200	A
$P_{tot}$	Power Dissipation Per IGBT		2500	W
<b>Diode</b>				
$V_{RRM}$	Repetitive Reverse Voltage	$T_J = 25\text{ }^{\circ}\text{C}$	1200	V
$I_{F(AV)}$	Average Forward Current	$T_c = 25\text{ }^{\circ}\text{C}$	600	A
$I_{FRM}$	Repetitive Peak Forward Current	$t_p = 1\text{ ms}$	1200	A
$I^2t$		$T_J = 125\text{ }^{\circ}\text{C}$ , t = 10 ms, $V_R = 0\text{ V}$	45	KA <sup>2</sup> s

### Electrical and Thermal Specifications ( $T_c = 25\text{ }^\circ\text{C}$ , unless otherwise specified)

Symbol	Parameters		Test Conditions	Min	Typ	Max	Unit
<b>IGBT</b>							
$V_{GE(th)}$	Gate Emitter Threshold Voltage		$V_{CE} = V_{GE}, I_C = 24\text{ mA}$	5.0	5.4	6.4	V
$V_{CE(sat)}$	Collector Emitter Saturation Voltage	chip	$I_C = 600\text{ A}, V_{GE} = 15\text{ V}, T_J = 25\text{ }^\circ\text{C}$		1.7	2.15	V
			$I_C = 600\text{ A}, V_{GE} = 15\text{ V}, T_J = 125\text{ }^\circ\text{C}$		1.9		
		terminal	$I_C = 600\text{ A}, V_{GE} = 15\text{ V}, T_J = 25\text{ }^\circ\text{C}$		2.0	2.5	V
			$I_C = 600\text{ A}, V_{GE} = 15\text{ V}, T_J = 125\text{ }^\circ\text{C}$		2.4		
$I_{CES}$	Collector Leakage Current		$V_{CE} = 1200\text{ V}, V_{GE} = 0\text{ V}, T_J = 25\text{ }^\circ\text{C}$			100	$\mu\text{A}$
			$V_{CE} = 1200\text{ V}, V_{GE} = 0\text{ V}, T_J = 125\text{ }^\circ\text{C}$			1	mA
$I_{GES}$	Gate Leakage Current		$V_{CE} = 0\text{ V}, V_{GE} = \pm 15\text{ V}, T_J = 125\text{ }^\circ\text{C}$	-400		400	nA
$R_{gint}$	Integrated Gate Resistor				0.5		$\Omega$
$Q_g$	Gate Charge		$V_{CE} = 600\text{ V}, I_C = 600\text{ A}, V_{GE} = \pm 15\text{ V}$		3.4		$\mu\text{C}$
$C_{res}$	Input Capacitance		$V_{CE} = 25\text{ V}, V_{GE} = 0\text{ V}, f = 1\text{ MHz}$		60.5		nF
$C_{res}$	Reverse Transfer Capacitance				1.8		nF
$t_{d(on)}$	Turn-on Delay Time		$V_{CC} = 600\text{ V}$ $I_C = 600\text{ A}$ $R_G = 5\text{ }\Omega$ $V_{GE} = \pm 15\text{ V}$ Inductive Load	$T_J = 25\text{ }^\circ\text{C}$		250	ns
				$T_J = 125\text{ }^\circ\text{C}$		280	ns
$t_r$	Rise Time			$T_J = 25\text{ }^\circ\text{C}$		220	ns
				$T_J = 125\text{ }^\circ\text{C}$		240	ns
$t_{d(off)}$	Turn-off Delay Time			$T_J = 25\text{ }^\circ\text{C}$		1000	ns
				$T_J = 125\text{ }^\circ\text{C}$		1100	ns
$t_f$	Fall Time			$T_J = 25\text{ }^\circ\text{C}$		170	ns
				$T_J = 125\text{ }^\circ\text{C}$		190	ns
$E_{on}$	Turn-on Energy			$T_J = 25\text{ }^\circ\text{C}$		20	mJ
				$T_J = 125\text{ }^\circ\text{C}$		35	mJ
$E_{off}$	Turn-off Energy		$T_J = 25\text{ }^\circ\text{C}$		105	mJ	
			$T_J = 125\text{ }^\circ\text{C}$		120	mJ	
$I_{SC}$	Short Circuit Current		$t_{psc} \leq 10\text{ }\mu\text{S}, V_{GE} = 15\text{ V}, T_J = 125\text{ }^\circ\text{C}, V_{CC} = 600\text{ V}$		2400		A
$R_{thJC}$	Junction-to-Case Thermal Resistance (Per IGBT)					0.06	K/W
<b>Diode</b>							
$V_F$	Forward Voltage	chip	$I_F = 600\text{ A}, V_{GE} = 0\text{ V}, T_J = 25\text{ }^\circ\text{C}$		2.1	2.5	V
			$I_F = 600\text{ A}, V_{GE} = 0\text{ V}, T_J = 125\text{ }^\circ\text{C}$		2.2		V
$t_{RR}$	Reverse Recovery Time		$I_F = 600\text{ A}, V_R = 600\text{ V}$ $di_p/dt = -2700\text{ A}/\mu\text{s}$ $T_J = 125\text{ }^\circ\text{C}$		330		ns
$I_{RRM}$	Max. Reverse Recovery Current				305		A
$Q_{RR}$	Reverse Recovery Charge				96		$\mu\text{C}$
$E_{rec}$	Reverse Recovery Energy				42		mJ
$R_{thJCD}$	Junction-to-Case Thermal Resistance (Per Diode)						0.1

### NTC Characteristics ( $T_c = 25\text{ }^\circ\text{C}$ , unless otherwise specified)

Symbol	Parameters	Test Conditions	Min	Typ	Max	Unit
$R_{25}$	Resistance	$T_c = 25\text{ }^\circ\text{C}$		5		K $\Omega$
$B_{25/50}$	$R_2 = R_{25} \exp [B_{25/50} (1/T_2 - 1/(298, 15\text{ K}))]$			3375		K

**Figure 1: Typical Output Characteristics IGBT Inverter**

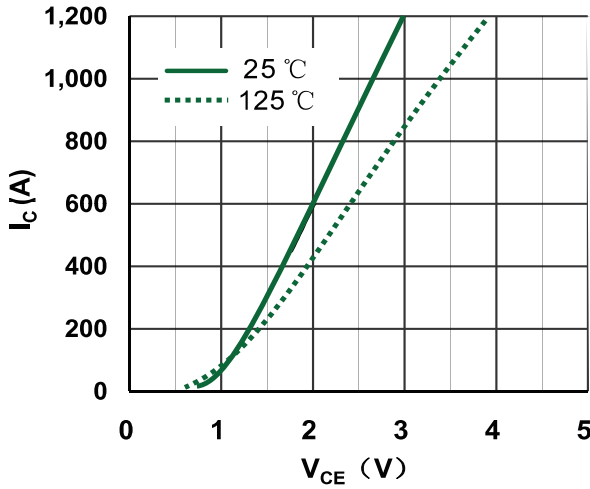

**Figure 2: Typical Output Characteristics IGBT Inverter**

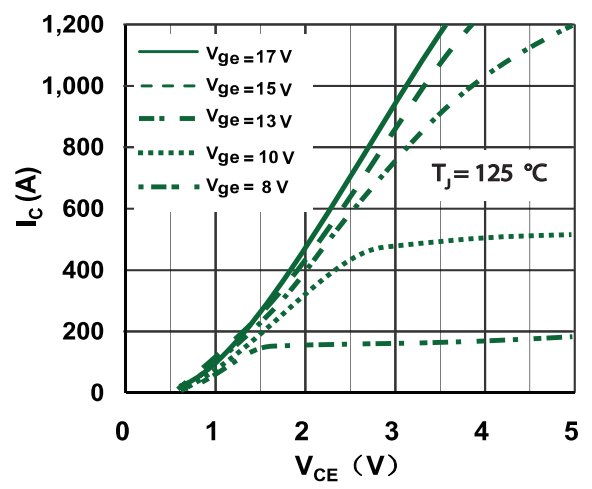

**Figure 3: Typical Transfer Characteristics IGBT Inverter**

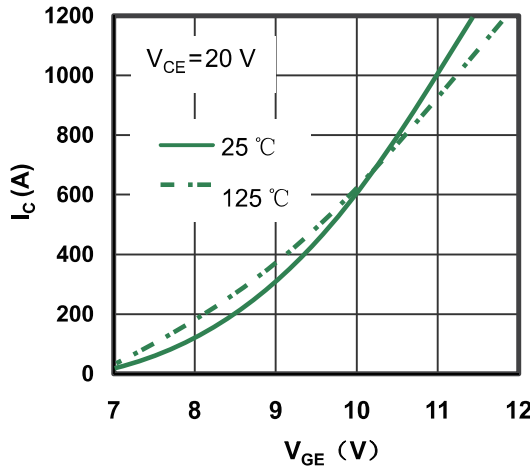

**Figure 4: Switching Energy vs. Gate Resistor IGBT Inverter**

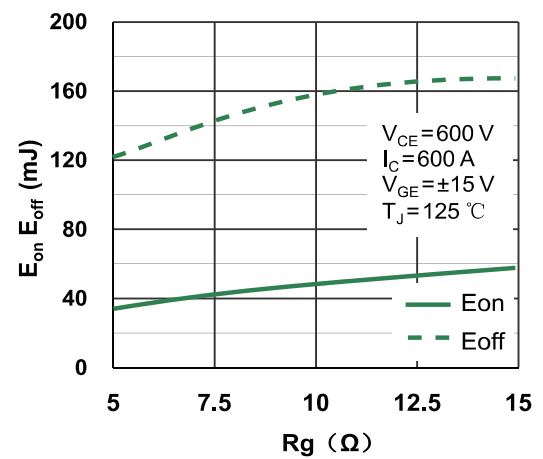

**Figure 5: Switching Energy vs. Collector Current IGBT Inverter**

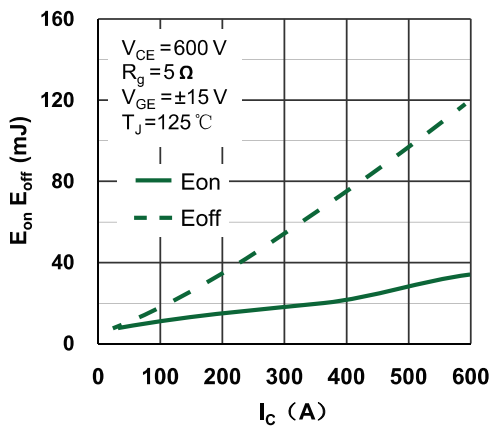

**Figure 6: Reverse Biased Safe Operating Area IGBT Inverter**

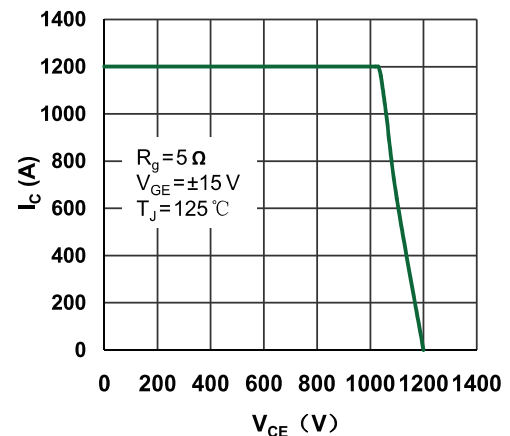

**Figure 7: Collector Current vs Case temperature IGBT -inverter**

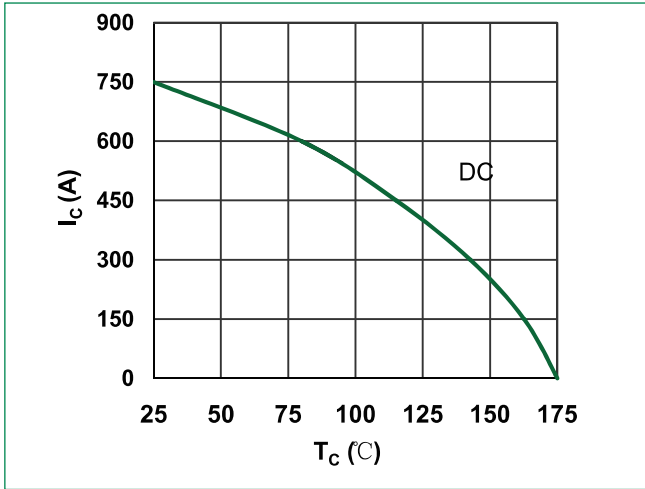

**Figure 8: Forward current vs Case temperature Diode -inverter**

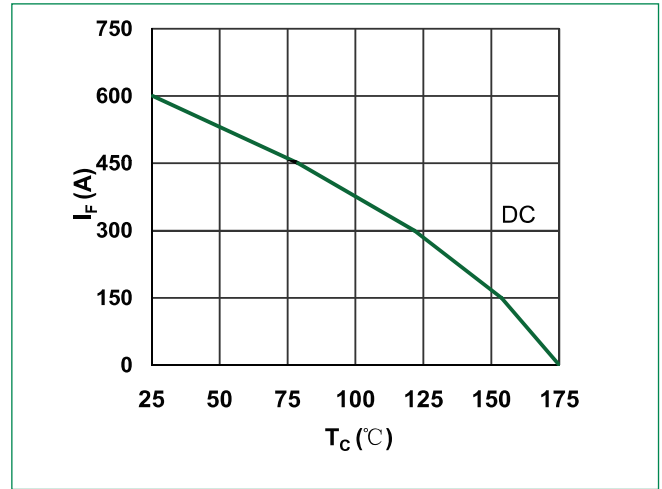

**Figure 9: Diode Forward Characteristics Diode -inverter**

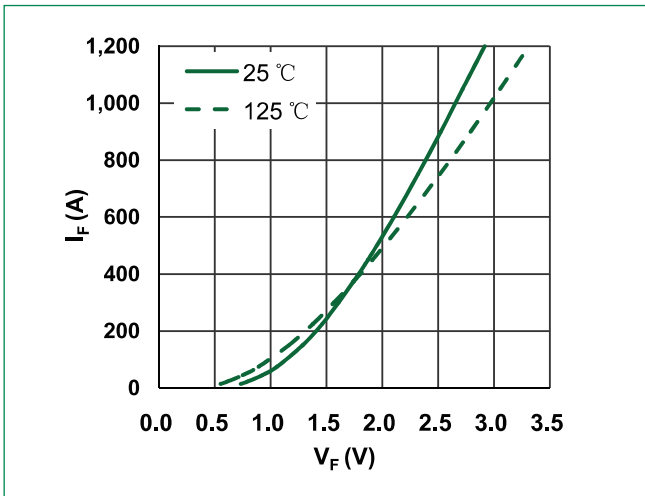

**Figure 10: Switching Energy vs Gate Resistor Diode -inverter**

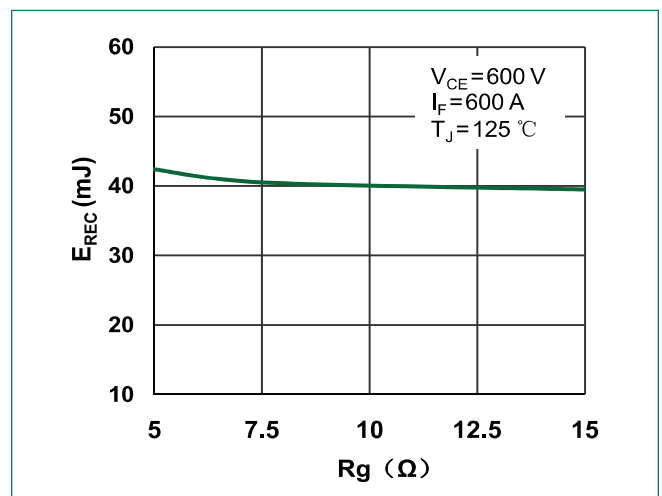

**Figure 11: Switching Energy vs Forward Current Diode-inverter**

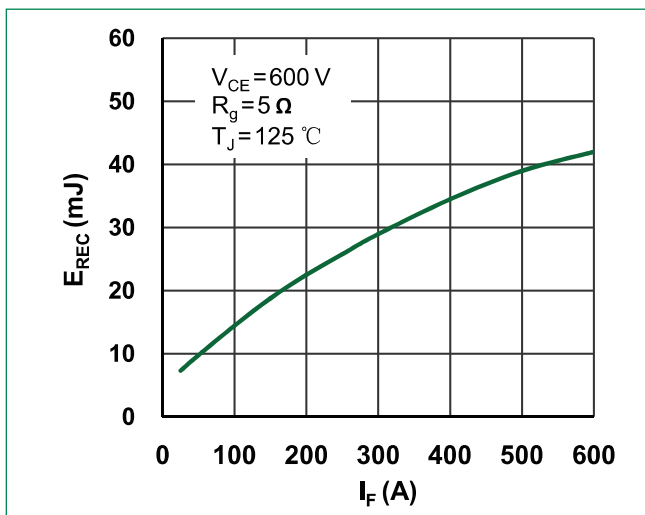

**Figure 12: Transient Thermal Impedance of Diode and IGBT -inverter**

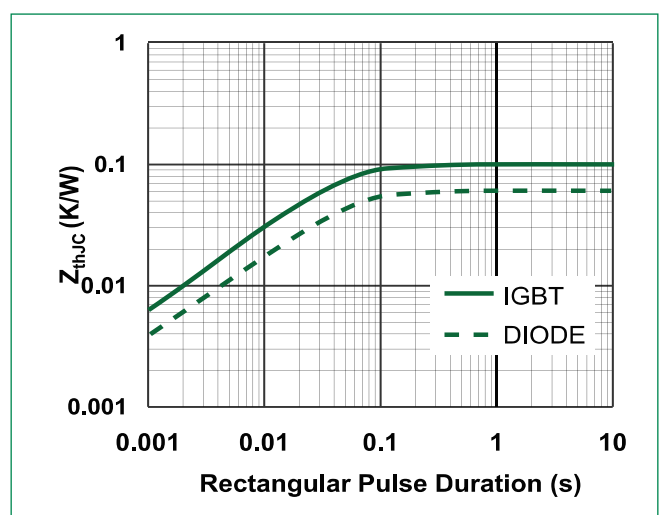

**Figure 13: NTC Characteristics**

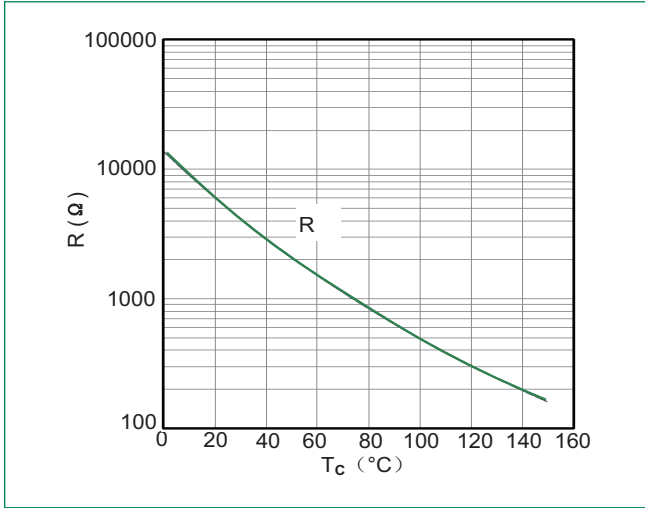

**Circuit Diagram**

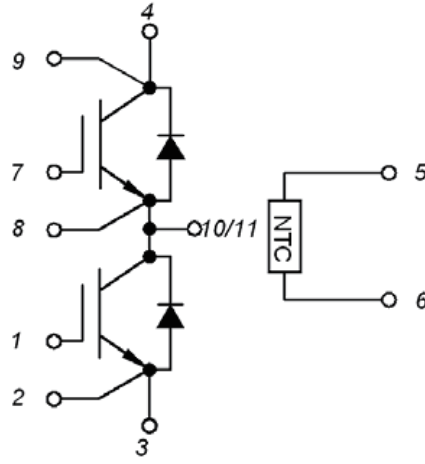

**Dimensions-Package WB**

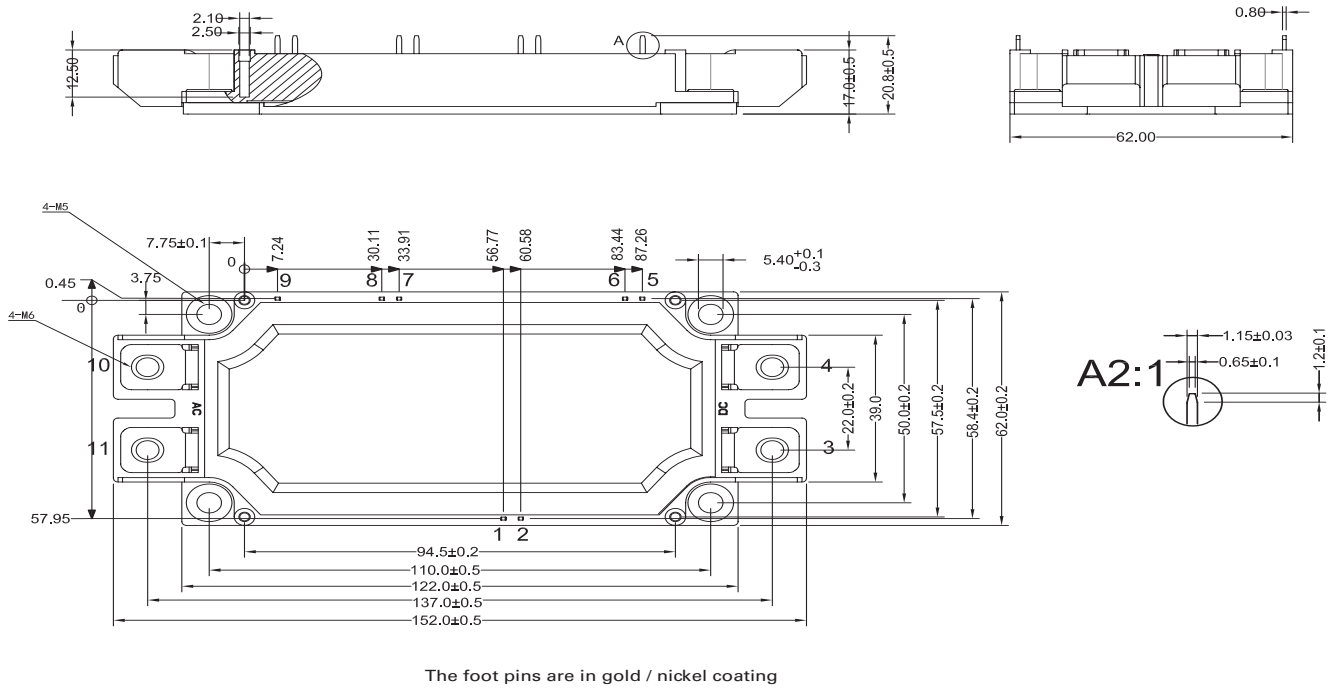

**Packing Options**

Part Number	Marking	Weight	Packing Mode	M.O.Q
MG12600WB-BR2MM	MG12600WB-BR2MM	350 g	Bulk Pack	60

**Part Numbering System**

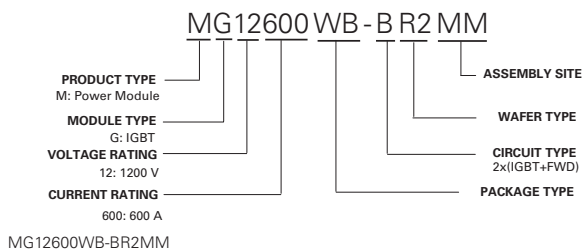

**Part Marking System**

