

**RADIATION HARDENED
 POWER MOSFET
 THRU-HOLE (Low-Ohmic TO-257AA)**

**IRHYB597Z30CM
 30V, P-CHANNEL
 R5 TECHNOLOGY**

Product Summary

Part Number	Radiation Level	RDS(on)	ID
IRHYB597Z30CM	100K Rads (Si)	0.048Ω	-20A*
IRHYB593Z30CM	300K Rads (Si)	0.048Ω	-20A*

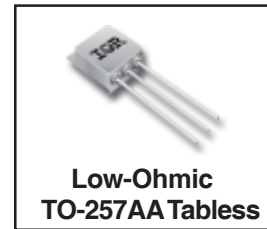

International Rectifier's R5™ technology provides high performance power MOSFETs for space applications. These devices have been characterized for Single Event Effects (SEE) with useful performance up to an LET of 80 (MeV/(mg/cm²)). The combination of low RDS(on) and low gate charge reduces the power losses in switching applications such as DC to DC converters and motor control. These devices retain all of the well established advantages of MOSFETs such as voltage control, fast switching, ease of paralleling and temperature stability of electrical parameters.

Features:

- Low RDS(on)
- Fast Switching
- Single Event Effect (SEE) Hardened
- Low Total Gate Charge
- Simple Drive Requirements
- Ease of Paralleling
- Hermetically Sealed
- Ceramic Eyelets
- Electrically Isolated
- Light Weight

Absolute Maximum Ratings

Pre-Irradiation

	Parameter		Units
ID @ VGS = -12V, TC = 25°C	Continuous Drain Current	-20*	A
ID @ VGS = -12V, TC = 100°C	Continuous Drain Current	-18	
IDM	Pulsed Drain Current ①	-80	
PD @ TC = 25°C	Max. Power Dissipation	75	W
	Linear Derating Factor	0.6	W/°C
VGS	Gate-to-Source Voltage	±20	V
EAS	Single Pulse Avalanche Energy ②	166	mJ
IAR	Avalanche Current ①	-20	A
EAR	Repetitive Avalanche Energy ①	7.5	mJ
dv/dt	Peak Diode Recovery dv/dt ③	-1.1	V/ns
TJ	Operating Junction	-55 to 150	°C
TSTG	Storage Temperature Range		
	Lead Temperature	300 (0.063in./1.6mm from case for 10s)	
	Weight	4.3 (Typical)	g

* Current is limited by package
 For footnotes refer to the last page

Electrical Characteristics @ T_j = 25°C (Unless Otherwise Specified)

	Parameter	Min	Typ	Max	Units	Test Conditions
BV _{DSS}	Drain-to-Source Breakdown Voltage	-30	—	—	V	V _{GS} = 0V, I _D = -1.0mA
ΔBV _{DSS} /ΔT _J	Temperature Coefficient of Breakdown Voltage	—	-0.03	—	V/°C	Reference to 25°C, I _D = -1.0mA
R _{DS(on)}	Static Drain-to-Source On-State Resistance	—	—	0.048	Ω	V _{GS} = -12V, I _D = -18A ④
V _{GS(th)}	Gate Threshold Voltage	-2.0	—	-4.0	V	V _{DS} = V _{GS} , I _D = -1.0mA
g _{fs}	Forward Transconductance	12	—	—	S (⑤)	V _{DS} = -15V, I _{DS} = -18A ④
I _{DSS}	Zero Gate Voltage Drain Current	—	—	-10	μA	V _{DS} = -24V, V _{GS} = 0V
		—	—	-25		V _{DS} = -24V, V _{GS} = 0V, T _J = 125°C
I _{GSS}	Gate-to-Source Leakage Forward	—	—	-100	nA	V _{GS} = -20V
I _{GSS}	Gate-to-Source Leakage Reverse	—	—	100		V _{GS} = 20V
Q _g	Total Gate Charge	—	—	45	nC	V _{GS} = -12V, I _D = -20A
Q _{gs}	Gate-to-Source Charge	—	—	20		V _{DS} = -15V
Q _{gd}	Gate-to-Drain ('Miller') Charge	—	—	13		
t _{d(on)}	Turn-On Delay Time	—	—	25	ns	V _{DD} = -15V, I _D = -20A
t _r	Rise Time	—	—	100		V _{GS} = -12V, R _G = 7.5Ω
t _{d(off)}	Turn-Off Delay Time	—	—	50		
t _f	Fall Time	—	—	70		
LS + LD	Total Inductance	—	6.8	—	nH	Measured from Drain lead (6mm / 0.25in. from package) to Source lead (6mm / 0.25in. from package)
C _{iss}	Input Capacitance	—	1690	—	pF	V _{GS} = 0V, V _{DS} = -25V
C _{oss}	Output Capacitance	—	980	—		f = 1.0MHz
C _{rss}	Reverse Transfer Capacitance	—	130	—		
R _g	Internal Gate Resistance	—	6.6	—		Ω

Source-Drain Diode Ratings and Characteristics

	Parameter	Min	Typ	Max	Units	Test Conditions
I _S	Continuous Source Current (Body Diode)	—	—	-20*	A	
I _{SM}	Pulse Source Current (Body Diode) ①	—	—	-80		
V _{SD}	Diode Forward Voltage	—	—	-5.0	V	T _j = 25°C, I _S = -20A, V _{GS} = 0V ④
t _{rr}	Reverse Recovery Time	—	—	75	ns	T _j = 25°C, I _F = -20A, di/dt ≤ -100A/μs
Q _{RR}	Reverse Recovery Charge	—	—	125	nC	V _{DD} ≤ -25V ④
t _{on}	Forward Turn-On Time	Intrinsic turn-on time is negligible. Turn-on speed is substantially controlled by LS + LD.				

* Current is limited by package

Thermal Resistance

	Parameter	Min	Typ	Max	Units	Test Conditions
R _{thJC}	Junction-to-Case	—	—	1.67	°C/W	
R _{thJA}	Junction-to-Ambient	—	—	80		Typical Socket Mount

Note: Corresponding Spice and Saber models are available on International Rectifier Web site.

For footnotes refer to the last page

Radiation Characteristics

IRHYB597Z30CM

International Rectifier Radiation Hardened MOSFETs are tested to verify their radiation hardness capability. The hardness assurance program at International Rectifier is comprised of two radiation environments. Every manufacturing lot is tested for total ionizing dose (per notes 5 and 6) using the TO-3 package. Both pre- and post-irradiation performance are tested and specified using the same drive circuitry and test conditions in order to provide a direct comparison.

Table 1. Electrical Characteristics @ Tj = 25°C, Post Total Dose Irradiation ^{⑤⑥}

	Parameter	100KRads(Si) ¹		300KRads(Si) ²		Units	Test Conditions
		Min	Max	Min	Max		
BV _{DSS}	Drain-to-Source Breakdown Voltage	-30	—	-30	—	V	V _{GS} = 0V, I _D = -1.0mA
V _{GS(th)}	Gate Threshold Voltage	-2.0	-4.0	-2.0	-5.0		V _{GS} = V _{DS} , I _D = -1.0mA
I _{GSS}	Gate-to-Source Leakage Forward	—	-100	—	-100	nA	V _{GS} = -20V
I _{GSS}	Gate-to-Source Leakage Reverse	—	100	—	100		V _{GS} = 20 V
I _{DSS}	Zero Gate Voltage Drain Current	—	-10	—	-10	μA	V _{DS} = -24V, V _{GS} = 0V
R _{DS(on)}	Static Drain-to-Source ^④ On-State Resistance (TO-3)	—	0.048	—	0.048	Ω	V _{GS} = -12V, I _D = -18A
R _{DS(on)}	Static Drain-to-Source On-State ^④ Resistance(Low-OhmicTO-257AA)	—	0.048	—	0.048	Ω	V _{GS} = -12V, I _D = -18A
V _{SD}	Diode Forward Voltage ^④	—	-5.0	—	-5.0	V	V _{GS} = 0V, I _S = -18A

1. Part number IRHYB597Z30CM

2. Part number IRHYB593Z30CM

International Rectifier radiation hardened MOSFETs have been characterized in heavy ion environment for Single Event Effects (SEE). Single Event Effects characterization is illustrated in Fig. a and Table 2.

Table 2. Single Event Effect Safe Operating Area

Ion	LET (MeV/(mg/cm ²))	Energy (MeV)	Range (μm)	V _{DS} (V)				
				@V _{GS} =0V	@V _{GS} =5V	@V _{GS} =10V	@V _{GS} =15V	@V _{GS} =20V
Br	37.5	278.5	36	- 30	- 30	- 30	- 30	- 30
I	59.7	320	31	- 30	- 30	- 30	- 30	- 25
Au	81.4	332	27	- 30	- 30	- 30	- 25	—

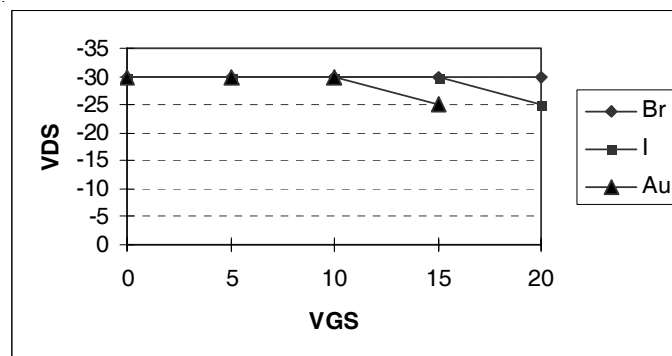

Fig a. Single Event Effect, Safe Operating Area

For footnotes refer to the last page

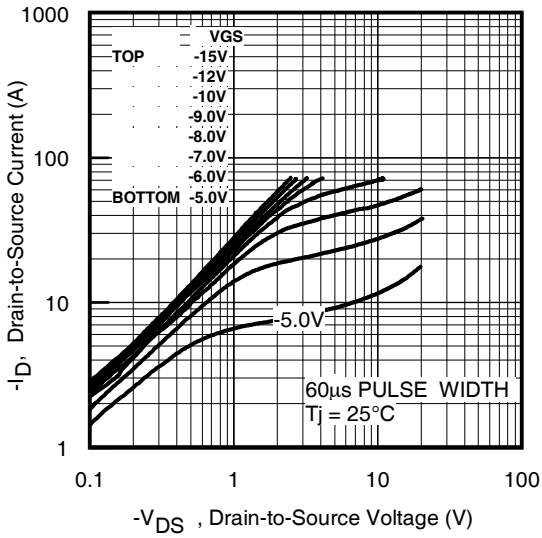

Fig 1. Typical Output Characteristics

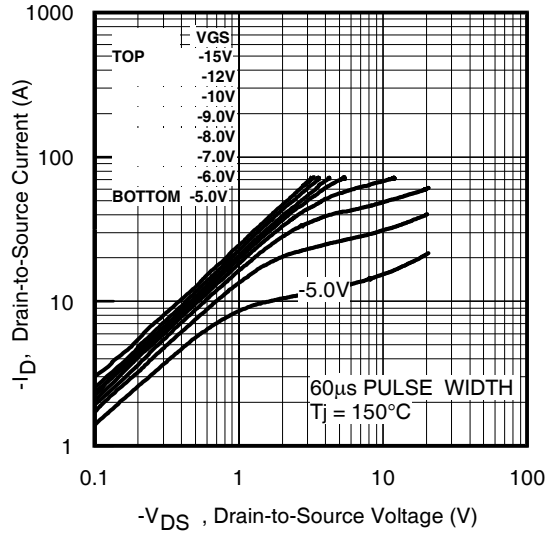

Fig 2. Typical Output Characteristics

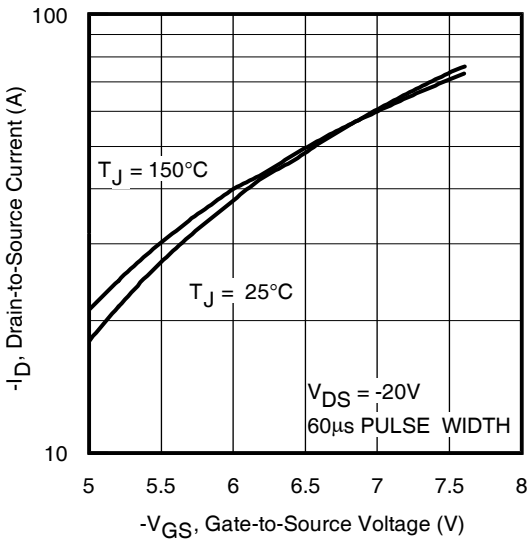

Fig 3. Typical Transfer Characteristics

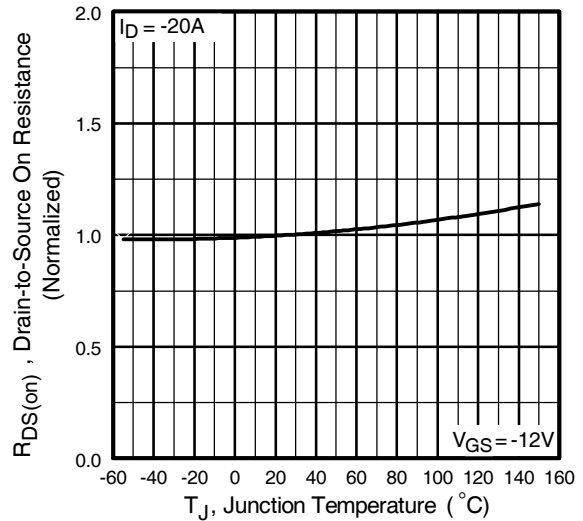

Fig 4. Normalized On-Resistance Vs. Temperature

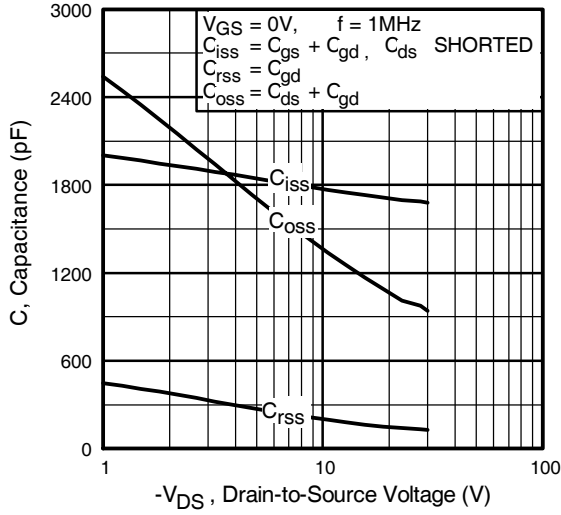

Fig 5. Typical Capacitance Vs. Drain-to-Source Voltage

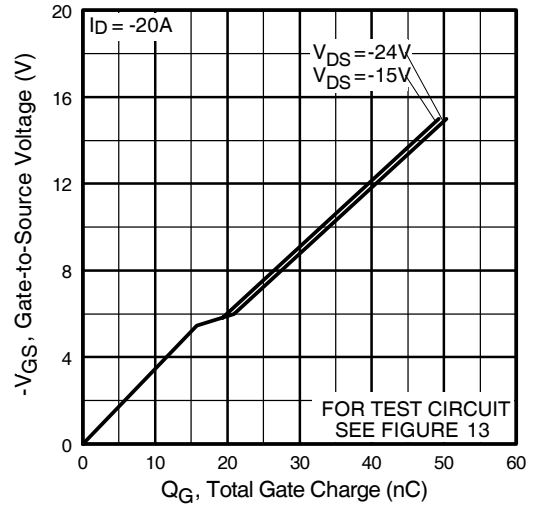

Fig 6. Typical Gate Charge Vs. Gate-to-Source Voltage

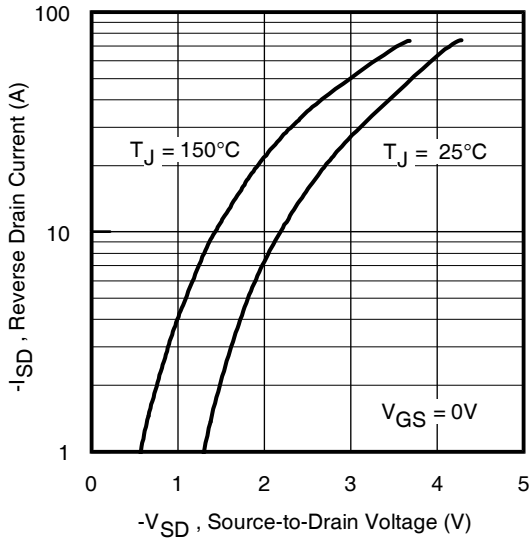

Fig 7. Typical Source-Drain Diode Forward Voltage

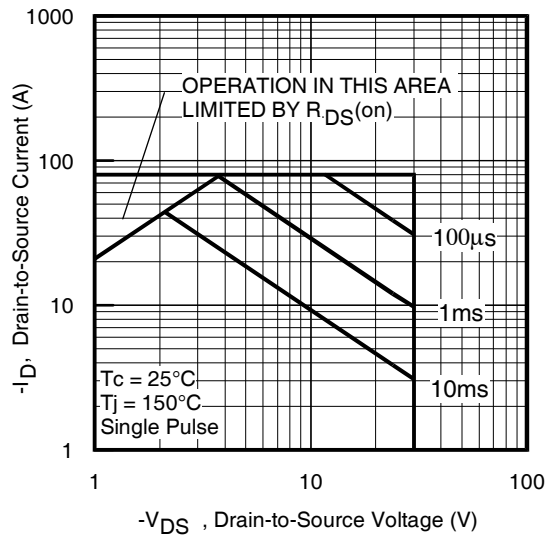

Fig 8. Maximum Safe Operating Area

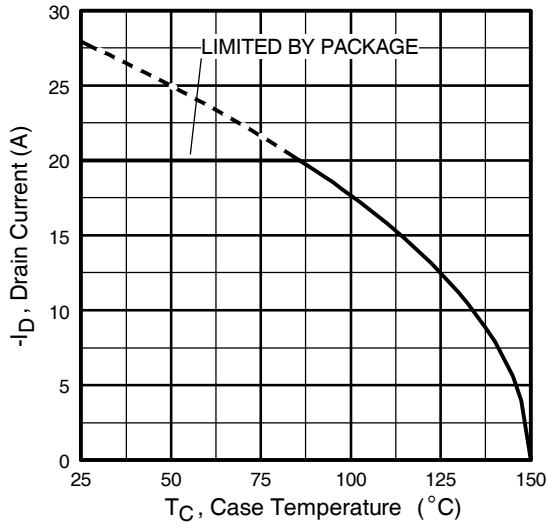

Fig 9. Maximum Drain Current Vs. Case Temperature

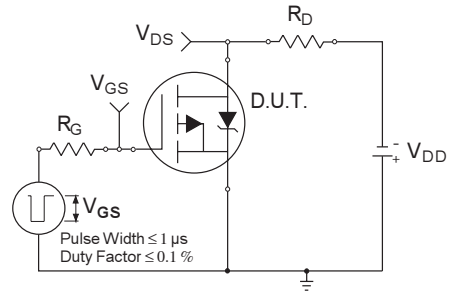

Fig 10a. Switching Time Test Circuit

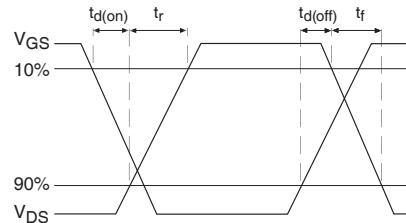

Fig 10b. Switching Time Waveforms

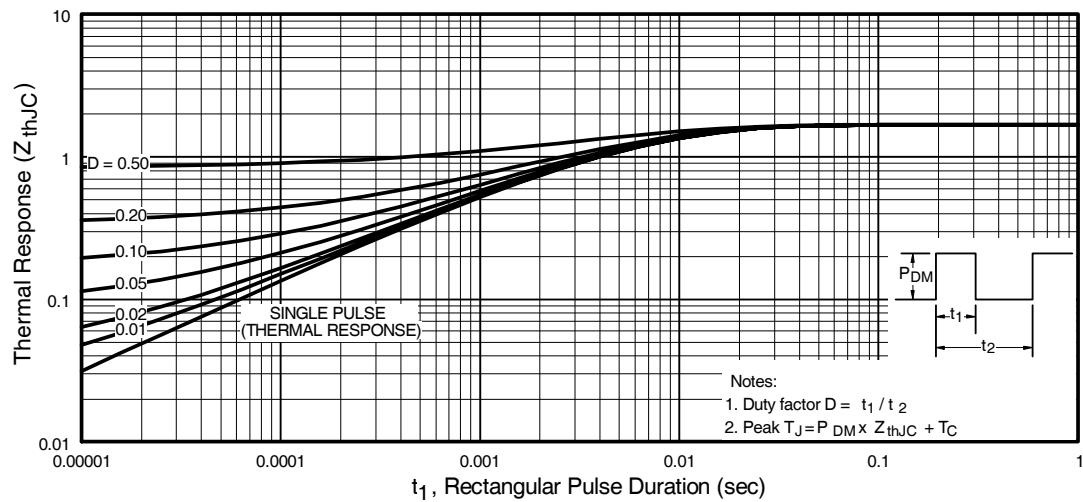

Fig 11. Maximum Effective Transient Thermal Impedance, Junction-to-Case

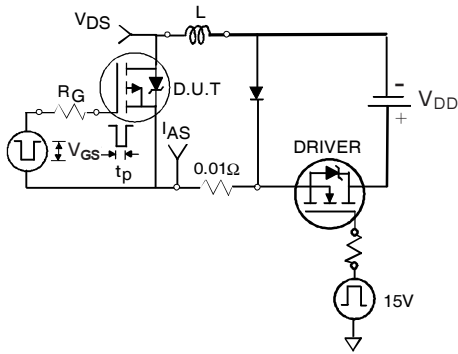

Fig 12a. Unclamped Inductive Test Circuit

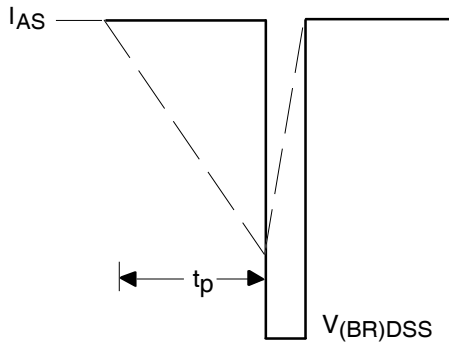

Fig 12b. Unclamped Inductive Waveforms

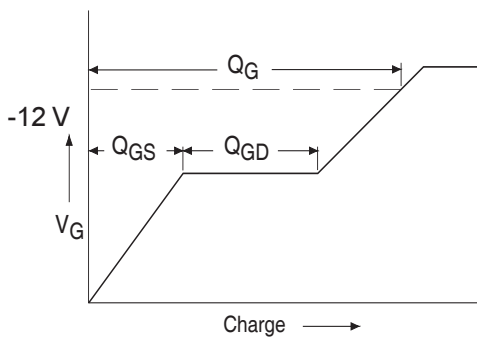

Fig 13a. Basic Gate Charge Waveform

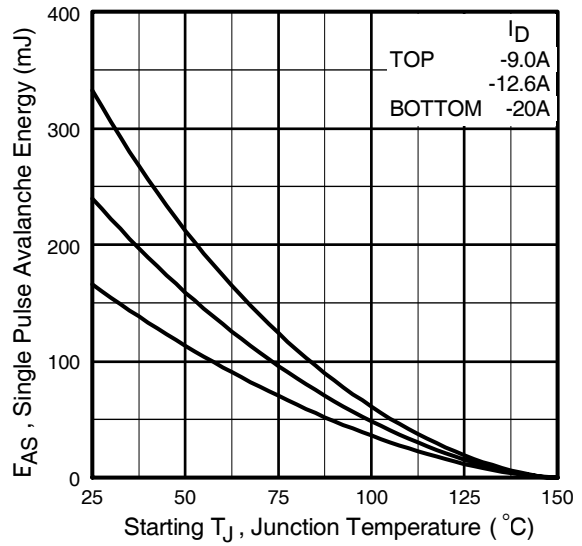

Fig 12c. Maximum Avalanche Energy Vs. Drain Current

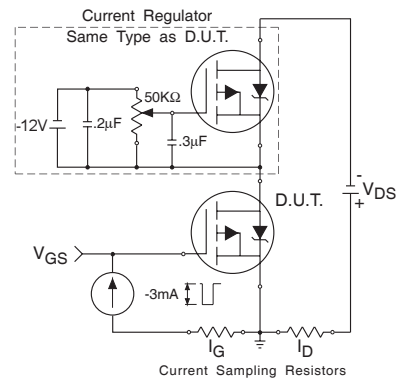

Fig 13b. Gate Charge Test Circuit

