

AUIRF2907ZS-7P

HEXFET® Power MOSFET

Features

- Advanced Process Technology
- Ultra Low On-Resistance
- 175°C Operating Temperature
- Fast Switching
- Repetitive Avalanche Allowed up to Tjmax
- Lead-Free, RoHS Compliant
- Automotive Qualified *

Description

Specifically designed for Automotive applications, this HEXFET® Power MOSFET utilizes the latest processing techniques to achieve extremely low on-resistance per silicon area. Additional features of this design are a 175°C junction operating temperature, fast switching speed and improved repetitive avalanche rating. These features combine to make this design an extremely efficient and reliable device for use in Automotive applications and a wide variety of other applications.

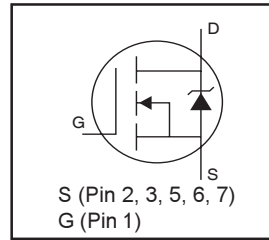

| | |
|--------------------------|--------------|
| $V_{(BR)DSS}$ | 75V |
| $R_{DS(on)}$ typ. | 3.0mΩ |
| | max. |
| I_D (Silicon Limited) | 180A |

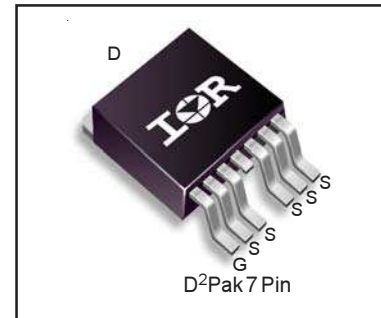

| | | |
|----------|----------|----------|
| G | D | S |
| Gate | Drain | Source |

Absolute Maximum Ratings

Stresses beyond those listed under “Absolute Maximum Ratings” may cause permanent damage to the device. These are stress ratings only; and functional operation of the device at these or any other condition beyond those indicated in the specifications is not implied. Exposure to absolute-maximum-rated conditions for extended periods may affect device reliability. The thermal resistance and power dissipation ratings are measured under board mounted and still air conditions. Ambient temperature (T_A) is 25°C, unless otherwise specified.

Absolute Maximum Ratings

| | Parameter | Max. | Units |
|---------------------------------|---|---------------------------|-------|
| $I_D @ T_C = 25^\circ\text{C}$ | Continuous Drain Current, $V_{GS} @ 10\text{V}$ (Silicon Limited) | 180 | A |
| $I_D @ T_C = 100^\circ\text{C}$ | Continuous Drain Current, $V_{GS} @ 10\text{V}$ (Silicon Limited) | 120 | |
| I_{DM} | Pulsed Drain Current ① | 700 | |
| $P_D @ T_C = 25^\circ\text{C}$ | Maximum Power Dissipation | 300 | W |
| | Linear Derating Factor | 2.0 | W/°C |
| V_{GS} | Gate-to-Source Voltage | ± 20 | V |
| E_{AS} | Single Pulse Avalanche Energy (Thermally Limited) ② | 160 | mJ |
| $E_{AS}(\text{tested})$ | Single Pulse Avalanche Energy Tested Value ⑤ | 410 | |
| I_{AR} | Avalanche Current ① | See Fig. 12a, 12b, 15, 16 | A |
| E_{AR} | Repetitive Avalanche Energy ① | | mJ |
| T_J | Operating Junction and Storage Temperature Range | -55 to + 175 | °C |
| T_{STG} | | | |
| | Soldering Temperature, for 10 seconds (1.6mm from case) | 300 | |
| | Mounting torque, 6-32 or M3 screw | 10 lbf•in (1.1N•m) | |

Thermal Resistance

| | Parameter | Typ. | Max. | Units |
|-----------------|---|------|------|-------|
| $R_{\theta JC}$ | Junction-to-Case ⑦ | — | 0.50 | °C/W |
| $R_{\theta CS}$ | Case-to-Sink, Flat, Greased Surface | 0.50 | — | |
| $R_{\theta JA}$ | Junction-to-Ambient | — | 62 | |
| $R_{\theta JA}$ | Junction-to-Ambient (PCB Mount, steady state) ⑧ | — | 40 | |

HEXFET® is a registered trademark of International Rectifier.

*Qualification standards can be found at <http://www.irf.com/>

www.irf.com

Static Electrical Characteristics @ T_J = 25°C (unless otherwise specified)

| | Parameter | Min. | Typ. | Max. | Units | Conditions |
|-------------------------------------|--------------------------------------|------|-------|------|-------|---|
| V _{(BR)DSS} | Drain-to-Source Breakdown Voltage | 75 | — | — | V | V _{GS} = 0V, I _D = 250μA |
| ΔBV _{DSS} /ΔT _J | Breakdown Voltage Temp. Coefficient | — | 0.066 | — | V/°C | Reference to 25°C, I _D = 1mA |
| R _{DS(on)} SMD | Static Drain-to-Source On-Resistance | — | 3.0 | 3.8 | mΩ | V _{GS} = 10V, I _D = 110A ③ |
| V _{GS(th)} | Gate Threshold Voltage | 2.0 | — | 4.0 | V | V _{DS} = V _{GS} , I _D = 250μA |
| g _{fs} | Forward Transconductance | 94 | — | — | S | V _{DS} = 25V, I _D = 110A |
| I _{DSS} | Drain-to-Source Leakage Current | — | — | 20 | μA | V _{DS} = 75V, V _{GS} = 0V |
| | | — | — | 250 | | V _{DS} = 75V, V _{GS} = 0V, T _J = 125°C |
| I _{GSS} | Gate-to-Source Forward Leakage | — | — | 200 | nA | V _{GS} = 20V |
| | Gate-to-Source Reverse Leakage | — | — | -200 | | V _{GS} = -20V |

Dynamic Electrical Characteristics @ T_J = 25°C (unless otherwise specified)

| | Parameter | Min. | Typ. | Max. | Units | Conditions |
|-----------------------|---------------------------------|------|------|------|-------|--|
| Q _g | Total Gate Charge | — | 170 | 260 | nC | I _D = 110A V _{DS} = 60V V _{GS} = 10V ③ |
| Q _{gs} | Gate-to-Source Charge | — | 55 | — | | |
| Q _{gd} | Gate-to-Drain ("Miller") Charge | — | 66 | — | | |
| t _{d(on)} | Turn-On Delay Time | — | 21 | — | ns | V _{DD} = 38V I _D = 110A R _G = 2.6Ω V _{GS} = 10V ③ |
| t _r | Rise Time | — | 90 | — | | |
| t _{d(off)} | Turn-Off Delay Time | — | 92 | — | | |
| t _f | Fall Time | — | 44 | — | nH | Between lead, 6mm (0.25in.) from package and center of die contact |
| L _D | Internal Drain Inductance | — | 4.5 | — | | |
| L _S | Internal Source Inductance | — | 7.5 | — | | |
| C _{iss} | Input Capacitance | — | 7580 | — | pF | V _{GS} = 0V V _{DS} = 25V f = 1.0MHz, See Fig. 5 |
| C _{oss} | Output Capacitance | — | 970 | — | | |
| C _{rss} | Reverse Transfer Capacitance | — | 540 | — | | |
| C _{oss} | Output Capacitance | — | 3750 | — | | |
| C _{oss} | Output Capacitance | — | 650 | — | | |
| C _{oss eff.} | Effective Output Capacitance ④ | — | 1110 | — | | |

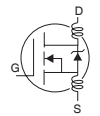

Diode Characteristics

| | Parameter | Min. | Typ. | Max. | Units | Conditions |
|-----------------|---|--|------|------|-------|---|
| I _S | Continuous Source Current (Body Diode) | — | — | 160 | A | MOSFET symbol showing the integral reverse p-n junction diode. |
| I _{SM} | Pulsed Source Current (Body Diode) ① | — | — | 700 | | |
| V _{SD} | Diode Forward Voltage | — | — | 1.3 | V | T _J = 25°C, I _S = 110A, V _{GS} = 0V ② |
| t _{rr} | Reverse Recovery Time | — | 35 | 53 | ns | T _J = 25°C, I _F = 110A, V _{DD} = 38V |
| Q _{rr} | Reverse Recovery Charge | — | 40 | 60 | nC | di/dt = 100A/μs ③ |
| t _{on} | Forward Turn-On Time | Intrinsic turn-on time is negligible (turn-on is dominated by LS+LD) | | | | |

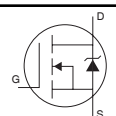

Notes:

- ① Repetitive rating; pulse width limited by max. junction temperature. (See fig. 11).
- ② Limited by T_{Jmax}, starting T_J = 25°C, L=0.026mH, R_G = 25Ω, I_{AS} = 110A, V_{GS} = 10V. Part not recommended for use above this value.
- ③ Pulse width ≤ 1.0ms; duty cycle ≤ 2%.
- ④ C_{oss eff.} is a fixed capacitance that gives the same charging time as C_{oss} while V_{DS} is rising from 0 to 80% V_{DSS}.
- ⑤ This value determined from sample failure population starting T_J = 25°C, L=0.026mH, R_G = 25Ω, I_{AS} = 110A, V_{GS} = 10V.
- ⑥ This is applied to D²Pak, when mounted on 1" square PCB (FR-4 or G-10 Material). For recommended footprint and soldering techniques refer to application note #AN-994.
- ⑦ R_θ is measured at T_J of approximately 90°C.
- ⑧ Solder mounted on IMS substrate.

Qualification Information†

| | | |
|-----------------------------------|---|--|
| Qualification Level | Automotive (per AEC-Q101) †† | |
| | Comments: This part number(s) passed Automotive qualification. IR's Industrial and Consumer qualification level is granted by extension of the higher Automotive level. | |
| Moisture Sensitivity Level | D2 PAK 7 Pin | MSL1 |
| ESD | Machine Model | Class M4(425V) (per AEC-Q101-002) |
| | Human Body Model | Class H2(4000V) (per AEC-Q101-001) |
| | Charged Device Model | Class C4 (1000V) (per AEC-Q101-005) |
| RoHS Compliant | Yes | |

† Qualification standards can be found at International Rectifier's web site: <http://www.irf.com/>

†† Exceptions to AEC-Q101 requirements are noted in the qualification report.

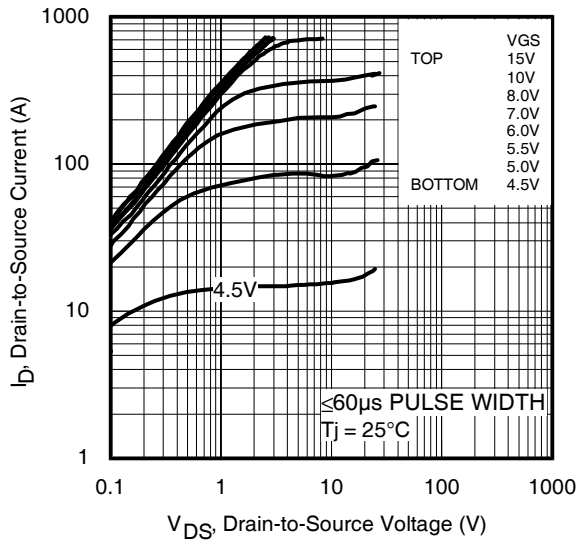

Fig 1. Typical Output Characteristics

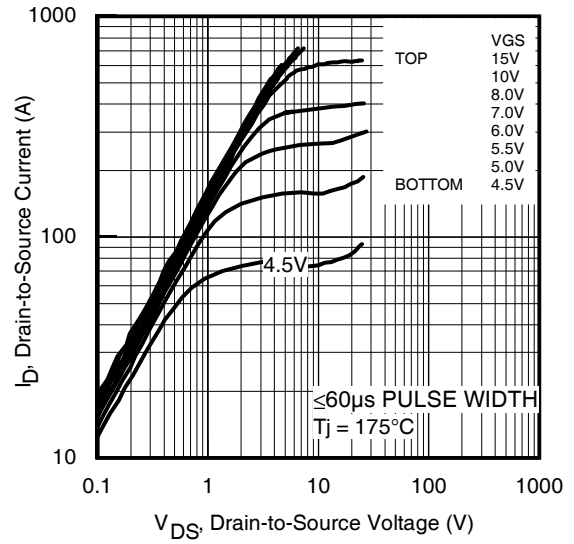

Fig 2. Typical Output Characteristics

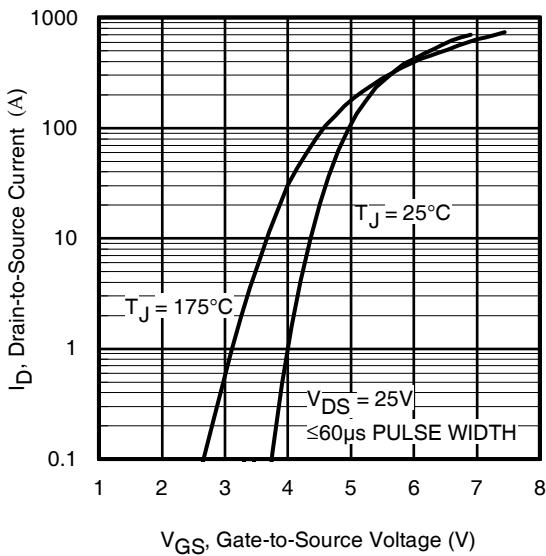

Fig 3. Typical Transfer Characteristics

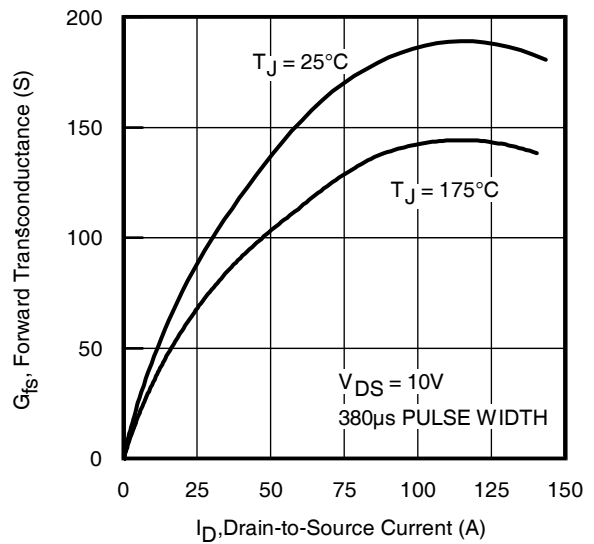

Fig 4. Typical Forward Transconductance vs. Drain Current

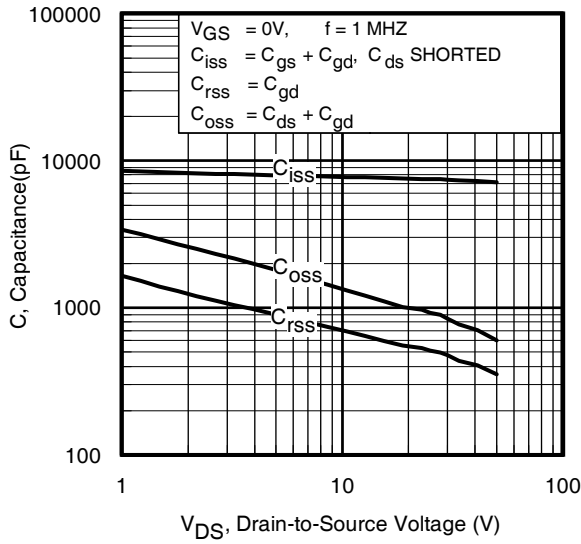

Fig 5. Typical Capacitance vs. Drain-to-Source Voltage

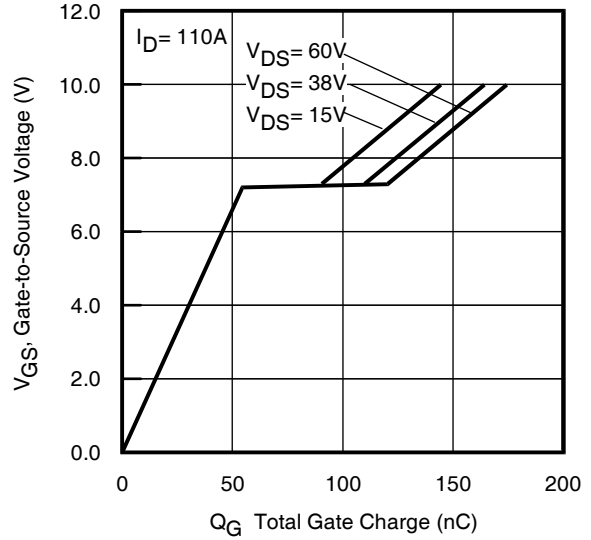

Fig 6. Typical Gate Charge vs. Gate-to-Source Voltage

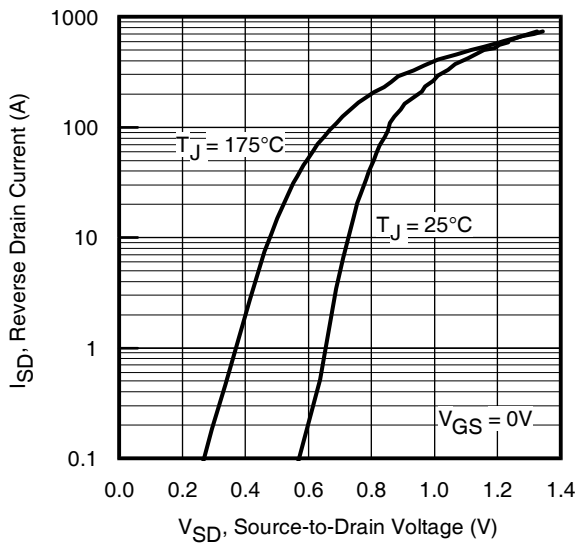

Fig 7. Typical Source-Drain Diode Forward Voltage

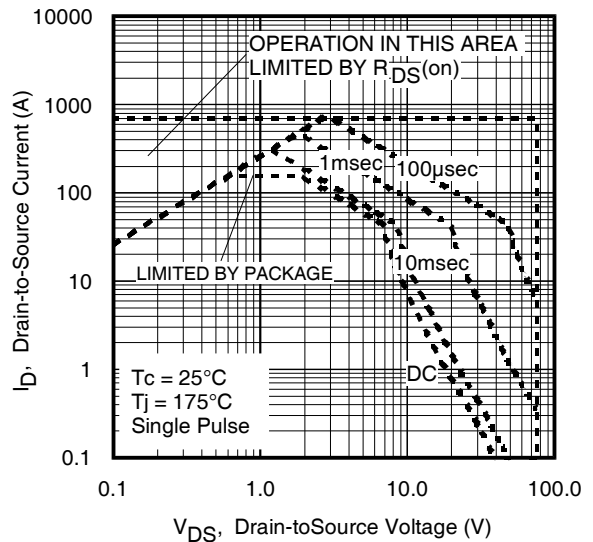

Fig 8. Maximum Safe Operating Area

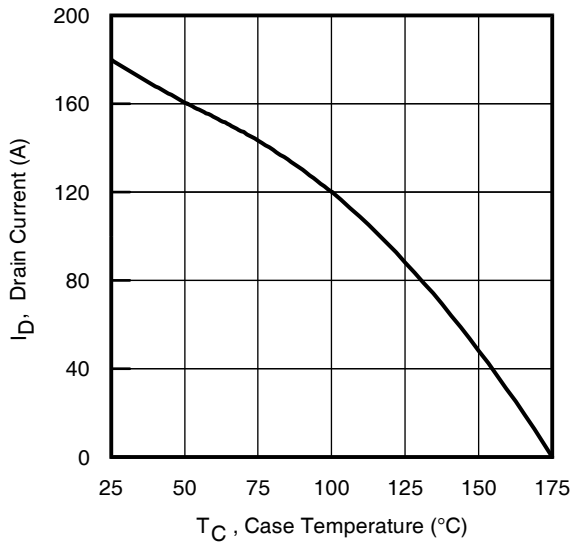

Fig 9. Maximum Drain Current vs. Case Temperature

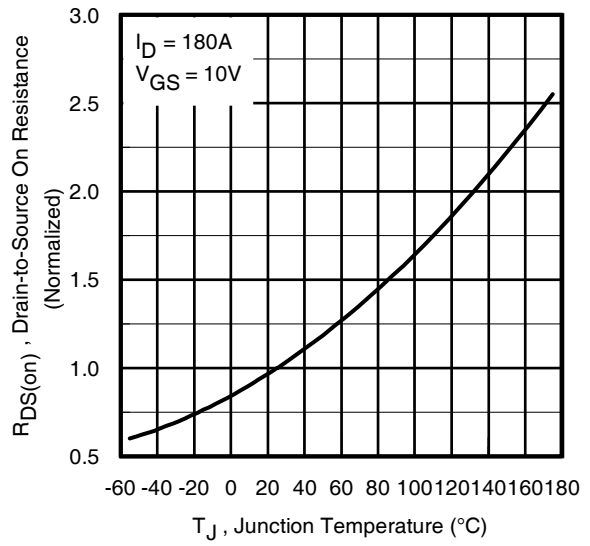

Fig 10. Normalized On-Resistance vs. Temperature

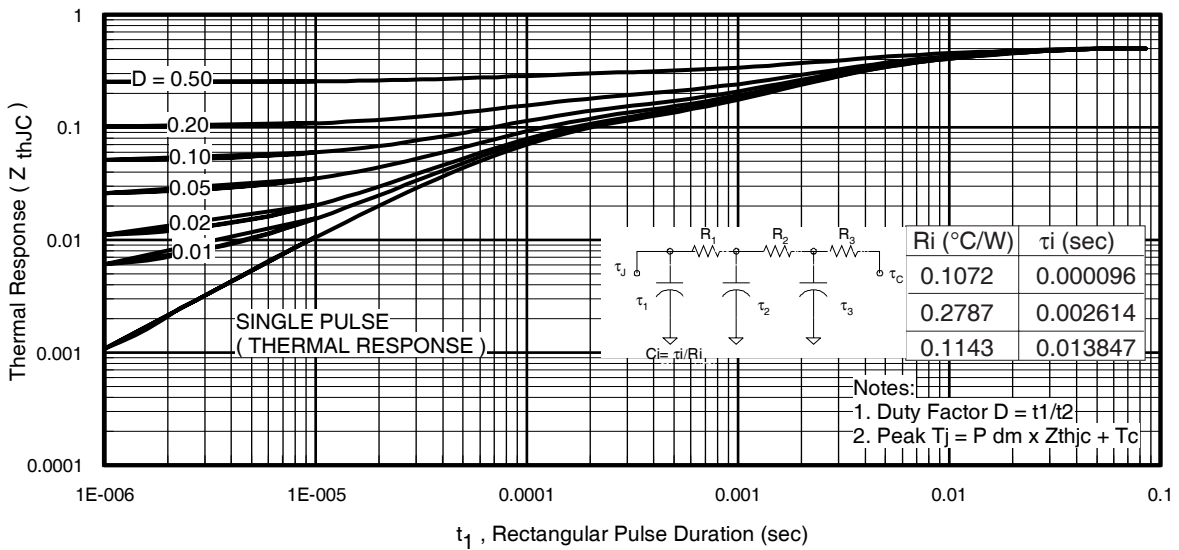

Fig 11. Maximum Effective Transient Thermal Impedance, Junction-to-Case

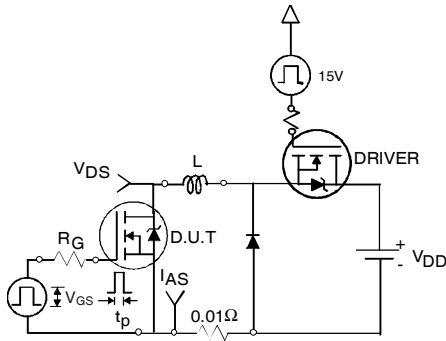

Fig 12a. Unclamped Inductive Test Circuit

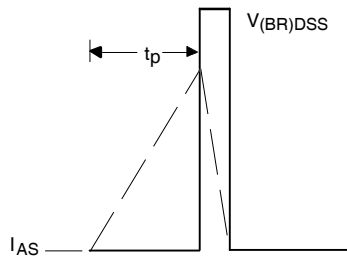

Fig 12b. Unclamped Inductive Waveforms

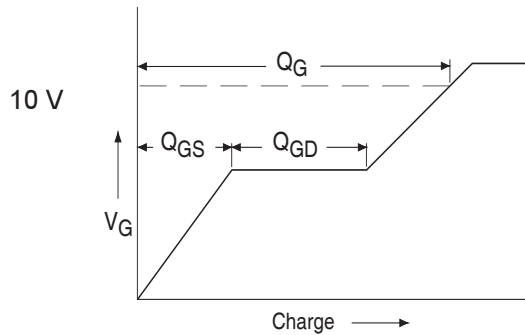

Fig 13a. Basic Gate Charge Waveform

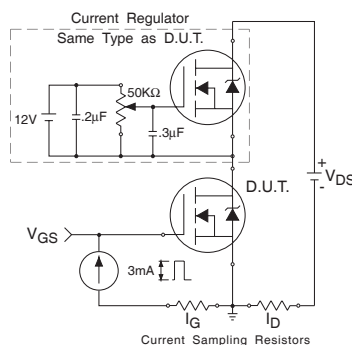

Fig 13b. Gate Charge Test Circuit

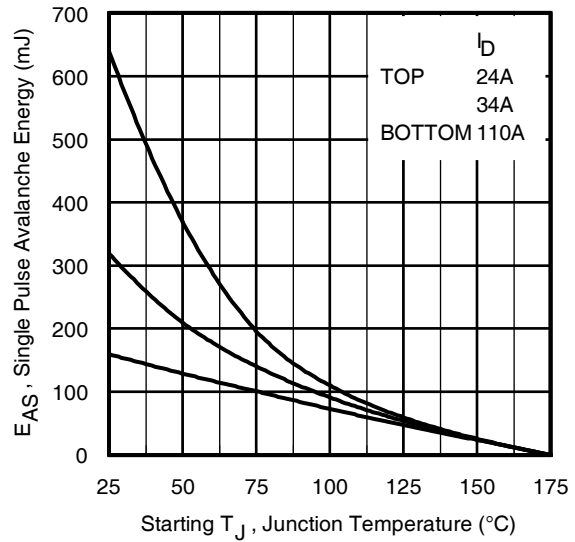

Fig 12c. Maximum Avalanche Energy vs. Drain Current

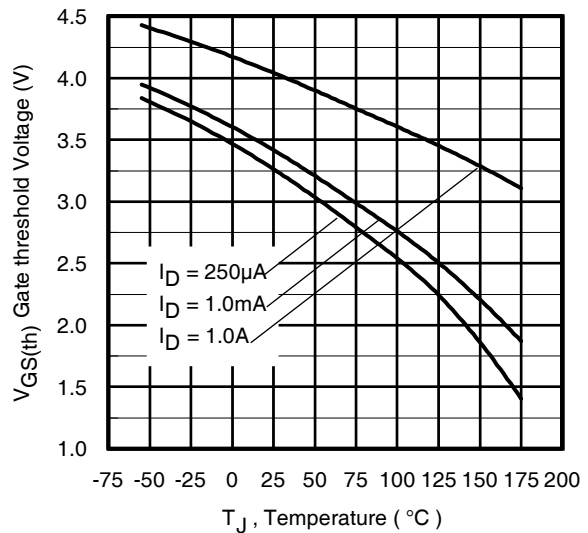

Fig 14. Threshold Voltage vs. Temperature

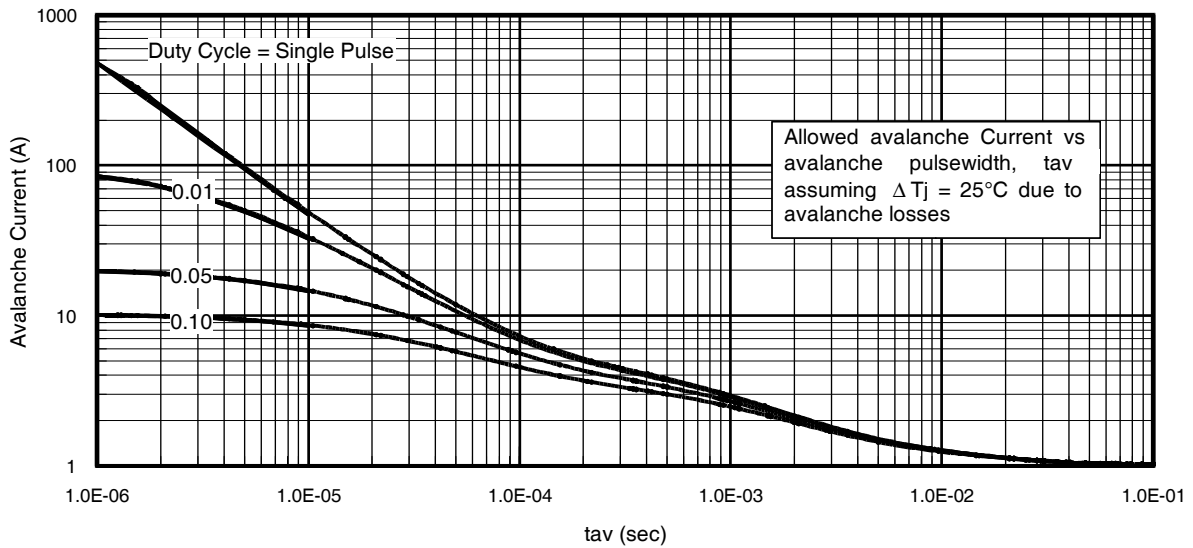

Fig 15. Typical Avalanche Current vs.Pulsewidth

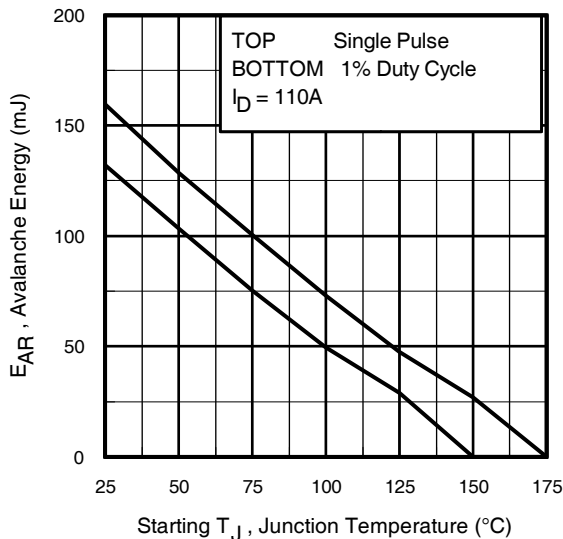

Fig 16. Maximum Avalanche Energy vs. Temperature

Notes on Repetitive Avalanche Curves , Figures 15, 16:
(For further info, see AN-1005 at www.irf.com)

1. Avalanche failures assumption:
Purely a thermal phenomenon and failure occurs at a temperature far in excess of T_{jmax} . This is validated for every part type.
2. Safe operation in Avalanche is allowed as long as T_{jmax} is not exceeded.
3. Equation below based on circuit and waveforms shown in Figures 12a, 12b.
4. $P_{D(ave)}$ = Average power dissipation per single avalanche pulse.
5. BV = Rated breakdown voltage (1.3 factor accounts for voltage increase during avalanche).
6. I_{av} = Allowable avalanche current.
7. ΔT = Allowable rise in junction temperature, not to exceed T_{jmax} (assumed as 25°C in Figure 15, 16).
 t_{av} = Average time in avalanche.
 D = Duty cycle in avalanche = $t_{av} \cdot f$
 $Z_{thJC}(D, t_{av})$ = Transient thermal resistance, see figure 11)

$$P_{D(ave)} = 1/2 (1.3 \cdot BV \cdot I_{av}) = \Delta T / Z_{thJC}$$

$$I_{av} = 2\Delta T / [1.3 \cdot BV \cdot Z_{th}]$$

$$E_{AS(AR)} = P_{D(ave)} \cdot t_{av}$$

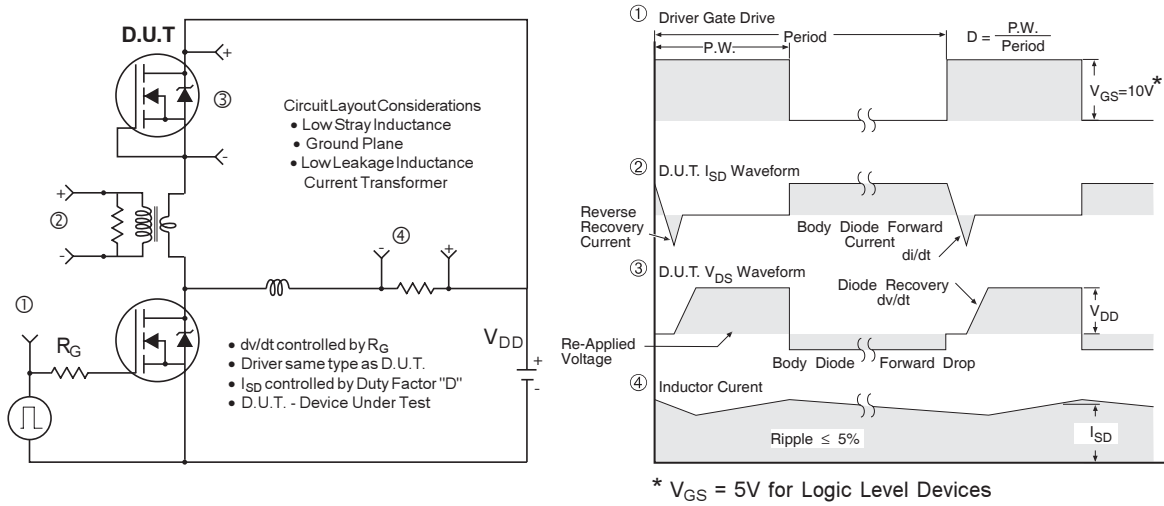

Fig 17. Peak Diode Recovery dv/dt Test Circuit for N-Channel HEXFET® Power MOSFETs

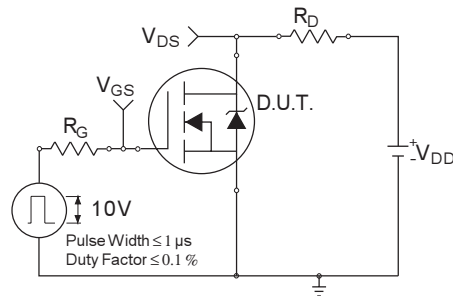

Fig 18a. Switching Time Test Circuit

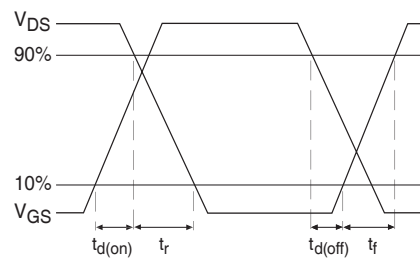
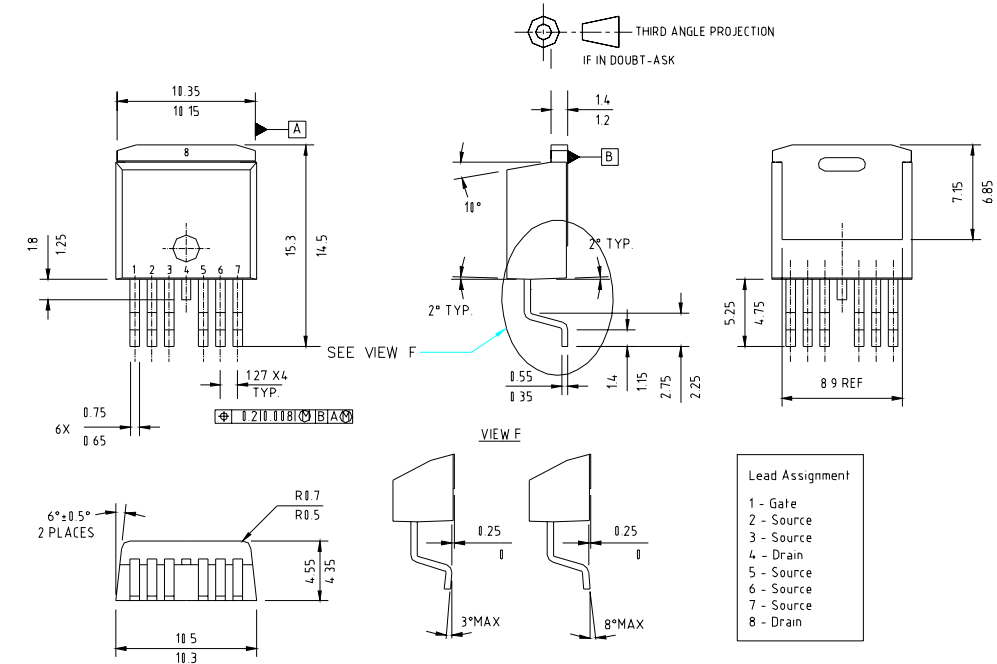

Fig 18b. Switching Time Waveforms

AUIRF2907ZS-7P

D²Pak - 7 Pin Package Outline

Dimensions are shown in millimeters (inches)



RECOMMENDED FOOTPRINT

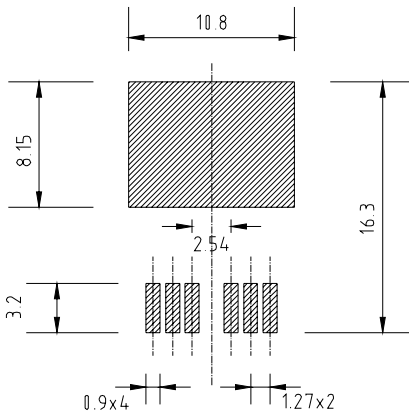

| REV | DATE | MODIFICATION |
|------|----------|----------------------|
| - | 18/03/03 | RAISED IAW ECN 3426 |
| Rev1 | 07/04/03 | CHANGED IAW ECN 3438 |
| A | 23/04/04 | ADD LEAD ASSIGNMENT |

D²Pak - 7 Pin Part Marking Information

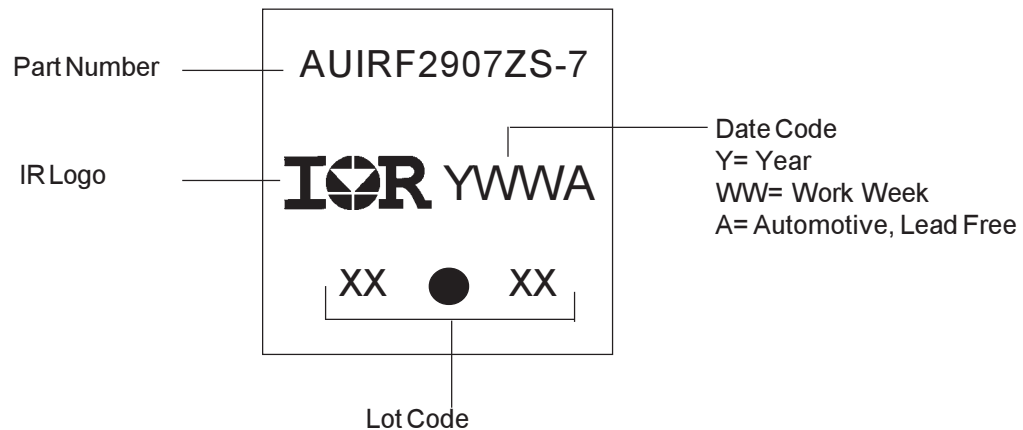

Note: For the most current drawing please refer to IR website at <http://www.irf.com/package/>

D²Pak - 7 Pin Tape and Reel

NOTES, TAPE & REEL, LABELLING:

1. TAPE AND REEL.

- 1.1 REEL SIZE 13 INCH DIAMETER.
- 1.2 EACH REEL CONTAINING 800 DEVICES.
- 1.3 THERE SHALL BE A MINIMUM OF 42 SEALED POCKETS CONTAINED IN THE LEADER AND A MINIMUM OF 15 SEALED POCKETS IN THE TRAILER.
- 1.4 PEEL STRENGTH MUST CONFORM TO THE SPEC. NO. 71-9667.
- 1.5 PART ORIENTATION SHALL BE AS SHOWN BELOW.
- 1.6 REEL MAY CONTAIN A MAXIMUM OF TWO UNIQUE LOT CODE/DATE CODE COMBINATIONS. REWORKED REELS MAY CONTAIN A MAXIMUM OF THREE UNIQUE LOT CODE/DATE CODE COMBINATIONS. HOWEVER, THE LOT CODES AND DATE CODES WITH THEIR RESPECTIVE QUANTITIES SHALL APPEAR ON THE BAR CODE LABEL FOR THE AFFECTED REEL.

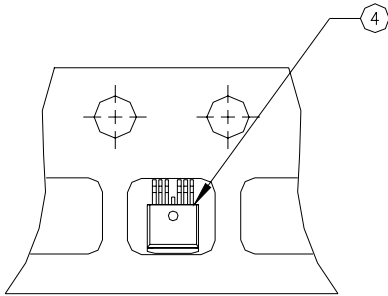

2. LABELLING (REEL AND SHIPPING BAG).

- 2.1 CUST. PART NUMBER (BAR CODE): IRFXXXXSTRL-7P
- 2.2 CUST. PART NUMBER (TEXT CODE): IRFXXXXSTRL-7P
- 2.3 I.R. PART NUMBER: IRFXXXXSTRL-7P
- 2.4 QUANTITY:
- 2.5 VENDOR CODE: IR
- 2.6 LOT CODE:
- 2.7 DATE CODE:

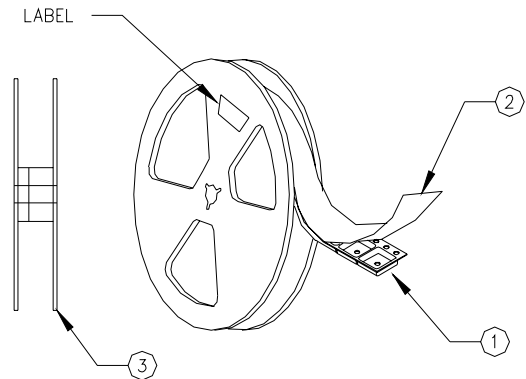

Ordering Information

| Base part number | Package Type | Standard Pack | | Complete Part Number |
|------------------|--------------|---------------------|----------|----------------------|
| | | Form | Quantity | |
| AUIRF2907ZS-7P | D2Pak | Tube | 50 | AUIRF2907ZS-7P |
| | | Tape and Reel Left | 800 | AUIRF2907ZS7PTL |
| | | Tape and Reel Right | 800 | AUIRF2907ZS7PTR |

IMPORTANT NOTICE

Unless specifically designated for the automotive market, International Rectifier Corporation and its subsidiaries (IR) reserve the right to make corrections, modifications, enhancements, improvements, and other changes to its products and services at any time and to discontinue any product or services without notice. Part numbers designated with the "AU" prefix follow automotive industry and / or customer specific requirements with regards to product discontinuance and process change notification. All products are sold subject to IR's terms and conditions of sale supplied at the time of order acknowledgment.

IR warrants performance of its hardware products to the specifications applicable at the time of sale in accordance with IR's standard warranty. Testing and other quality control techniques are used to the extent IR deems necessary to support this warranty. Except where mandated by government requirements, testing of all parameters of each product is not necessarily performed.

IR assumes no liability for applications assistance or customer product design. Customers are responsible for their products and applications using IR components. To minimize the risks with customer products and applications, customers should provide adequate design and operating safeguards.

Reproduction of IR information in IR data books or data sheets is permissible only if reproduction is without alteration and is accompanied by all associated warranties, conditions, limitations, and notices. Reproduction of this information with alterations is an unfair and deceptive business practice. IR is not responsible or liable for such altered documentation. Information of third parties may be subject to additional restrictions.

Resale of IR products or serviced with statements different from or beyond the parameters stated by IR for that product or service voids all express and any implied warranties for the associated IR product or service and is an unfair and deceptive business practice. IR is not responsible or liable for any such statements.

IR products are not designed, intended, or authorized for use as components in systems intended for surgical implant into the body, or in other applications intended to support or sustain life, or in any other application in which the failure of the IR product could create a situation where personal injury or death may occur. Should Buyer purchase or use IR products for any such unintended or unauthorized application, Buyer shall indemnify and hold International Rectifier and its officers, employees, subsidiaries, affiliates, and distributors harmless against all claims, costs, damages, and expenses, and reasonable attorney fees arising out of, directly or indirectly, any claim of personal injury or death associated with such unintended or unauthorized use, even if such claim alleges that IR was negligent regarding the design or manufacture of the product.

IR products are neither designed nor intended for use in military/aerospace applications or environments unless the IR products are specifically designated by IR as military-grade or "enhanced plastic." Only products designated by IR as military-grade meet military specifications. Buyers acknowledge and agree that any such use of IR products which IR has not designated as military-grade is solely at the Buyer's risk, and that they are solely responsible for compliance with all legal and regulatory requirements in connection with such use.

IR products are neither designed nor intended for use in automotive applications or environments unless the specific IR products are designated by IR as compliant with ISO/TS 16949 requirements and bear a part number including the designation "AU". Buyers acknowledge and agree that, if they use any non-designated products in automotive applications, IR will not be responsible for any failure to meet such requirements

For technical support, please contact IR's Technical Assistance Center
<http://www.irf.com/technical-info/>

WORLD HEADQUARTERS:
233 Kansas St., El Segundo, California 90245
Tel: (310) 252-7105