

TOP VIEW

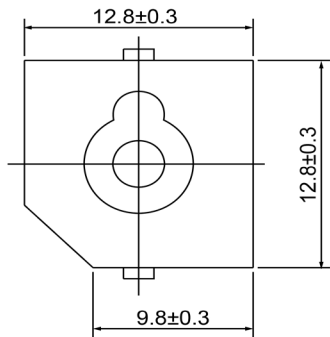

SIDE VIEW (1)

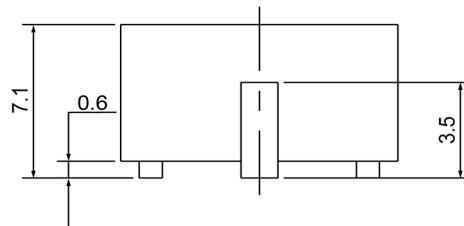

SIDE VIEW (2)

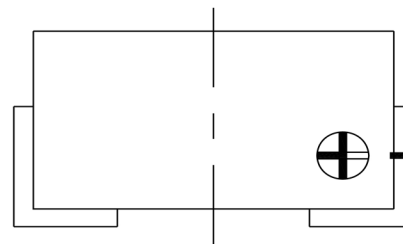

BOTTOM VIEW

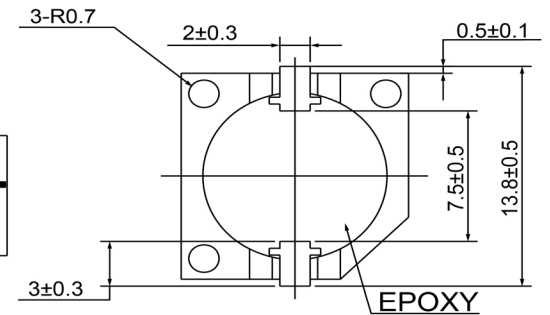

Specifications		
Description	Value	Unit
Technology	Electro-Mechanical	
Resonant Frequency	2,400	(Hz)
Rated Voltage	5	(V)
SPL @ 10cm	85	(dBA)
Coil Resistance	45	(ohm)
Mount Type	Surface Mount	
Voltage Range	3 ~ 8	(V)
Max Rated Current	40	(mA)
Housing Material	PPS	
Operating Temperature	-30 ~ +70	°C
Storage Temperature	-40 ~ +85	°C
Weight	2	(g)

Notes	
1) All dimensions are in mm unless otherwise noted	
2) All parts meet RoHS	



Revision History					
Version	Description	Date	Approved		
1	Released from Engineering	10/21/2013	J.S		
Drawn by	Date	Checked by	Date	Approved by	Date
A.B.	10/21/2013	C.E.	10/21/2013	J.S	10/21/2013

Electro-Mechanical Transducer

TE122405-5