

## High Speed Infrared Emitting Diode, 850 nm, GaAlAs Double Hetero

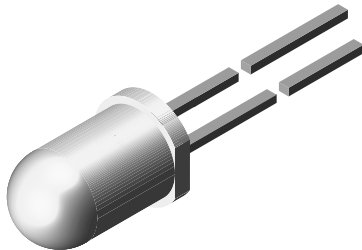

94 8389

### DESCRIPTION

TSHG6210 is an infrared, 850 nm emitting diode in GaAlAs double hetero (DH) technology with high radiant power and high speed, molded in a clear, untinted plastic package.

### FEATURES

- Package type: leaded
- Package form: T-1 $\frac{3}{4}$
- Dimensions (in mm):  $\varnothing$  5
- Peak wavelength:  $\lambda_p = 850$  nm
- High reliability
- High radiant power
- High radiant intensity
- Angle of half intensity:  $\varphi = \pm 10^\circ$
- Low forward voltage
- Suitable for high pulse current operation
- High modulation bandwidth:  $f_c = 18$  MHz
- Good spectral matching with CMOS cameras
- Compliant to RoHS Directive 2002/95/EC and in accordance to WEEE 2002/96/EC



**RoHS**  
COMPLIANT  
**GREEN**  
(5-2008)\*\*

### APPLICATIONS

- Infrared radiation source for operation with CMOS cameras
- High speed IR data transmission
- Smoke-automatic fire detectors

### PRODUCT SUMMARY

COMPONENT	$I_e$ (mW/sr)	$\varphi$ (deg)	$\lambda_p$ (nm)	$t_r$ (ns)
TSHG6210	230	$\pm 10$	850	20

#### Note

- Test conditions see table "Basic Characteristics"

### ORDERING INFORMATION

ORDERING CODE	PACKAGING	REMARKS	PACKAGE FORM
TSHG6210	Bulk	MOQ: 4000 pcs, 4000 pcs/bulk	T-1 $\frac{3}{4}$

#### Note

- MOQ: minimum order quantity

### ABSOLUTE MAXIMUM RATINGS ( $T_{amb} = 25^\circ\text{C}$ , unless otherwise specified)

PARAMETER	TEST CONDITION	SYMBOL	VALUE	UNIT
Reverse voltage		$V_R$	5	V
Forward current		$I_F$	100	mA
Peak forward current	$t_p/T = 0.5$ , $t_p = 100 \mu\text{s}$	$I_{FM}$	200	mA
Surge forward current	$t_p = 100 \mu\text{s}$	$I_{FSM}$	1	A
Power dissipation		$P_V$	180	mW
Junction temperature		$T_j$	100	$^\circ\text{C}$
Operating temperature range		$T_{amb}$	- 40 to + 85	$^\circ\text{C}$
Storage temperature range		$T_{stg}$	- 40 to + 100	$^\circ\text{C}$
Soldering temperature	$t \leq 5$ s, 2 mm from case	$T_{sd}$	260	$^\circ\text{C}$
Thermal resistance junction/ambient	J-STD-051, leads 7 mm, soldered on PCB	$R_{thJA}$	230	K/W

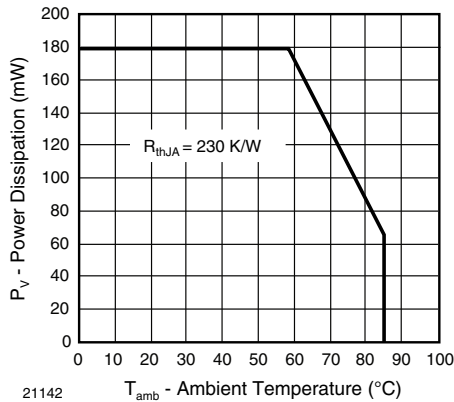

Fig. 1 - Power Dissipation Limit vs. Ambient Temperature

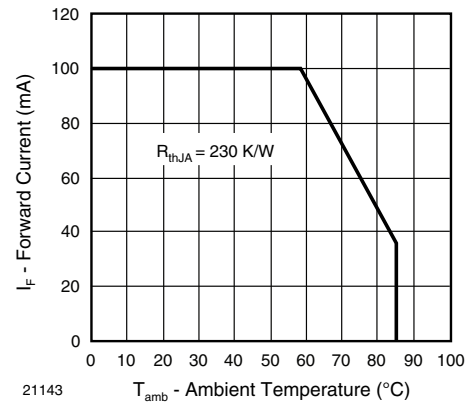

Fig. 2 - Forward Current Limit vs. Ambient Temperature

<b>BASIC CHARACTERISTICS</b> ( $T_{amb} = 25\text{ }^\circ\text{C}$ , unless otherwise specified)						
PARAMETER	TEST CONDITION	SYMBOL	MIN.	TYP.	MAX.	UNIT
Forward voltage	$I_F = 100\text{ mA}$ , $t_p = 20\text{ ms}$	$V_F$		1.5	1.8	V
	$I_F = 1\text{ A}$ , $t_p = 100\text{ }\mu\text{s}$	$V_F$		2.3		V
Temperature coefficient of $V_F$	$I_F = 1\text{ mA}$	$TK_{V_F}$		-1.8		mV/K
Reverse current	$V_R = 5\text{ V}$	$I_R$			10	$\mu\text{A}$
Junction capacitance	$V_R = 0\text{ V}$ , $f = 1\text{ MHz}$ , $E = 0$	$C_j$		125		pF
Radiant intensity	$I_F = 100\text{ mA}$ , $t_p = 20\text{ ms}$	$I_e$	140	230	420	mW/sr
	$I_F = 1\text{ A}$ , $t_p = 100\text{ }\mu\text{s}$	$I_e$		2300		mW/sr
Radiant power	$I_F = 100\text{ mA}$ , $t_p = 20\text{ ms}$	$\phi_e$		55		mW
Temperature coefficient of $\phi_e$	$I_F = 100\text{ mA}$	$TK_{\phi_e}$		-0.35		%/K
Angle of half intensity		$\phi$		$\pm 10$		deg
Peak wavelength	$I_F = 100\text{ mA}$	$\lambda_p$	820	850	880	nm
Spectral bandwidth	$I_F = 100\text{ mA}$	$\Delta\lambda$		40		nm
Temperature coefficient of $\lambda_p$	$I_F = 100\text{ mA}$	$TK_{\lambda_p}$		0.25		nm/K
Rise time	$I_F = 100\text{ mA}$	$t_r$		20		ns
Fall time	$I_F = 100\text{ mA}$	$t_f$		13		ns
Cut-off frequency	$I_{DC} = 70\text{ mA}$ , $I_{AC} = 30\text{ mA pp}$	$f_c$		18		MHz
Virtual source diameter		$d$		3.7		mm

**BASIC CHARACTERISTICS** ( $T_{amb} = 25\text{ }^{\circ}\text{C}$ , unless otherwise specified)

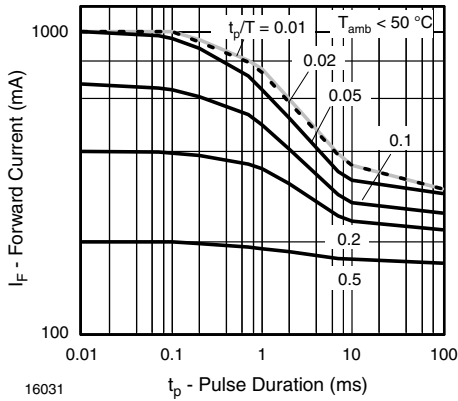

Fig. 3 - Pulse Forward Current vs. Pulse Duration

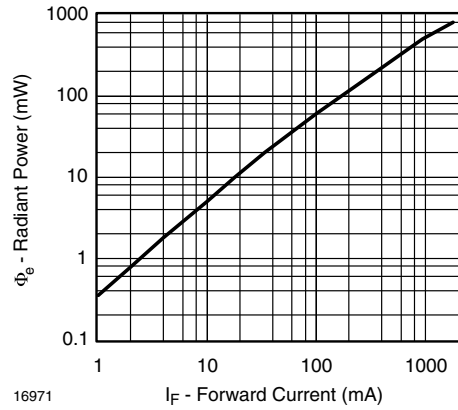

Fig. 6 - Radiant Power vs. Forward Current

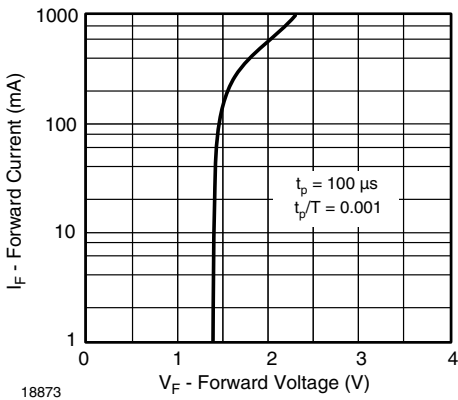

Fig. 4 - Forward Current vs. Forward Voltage

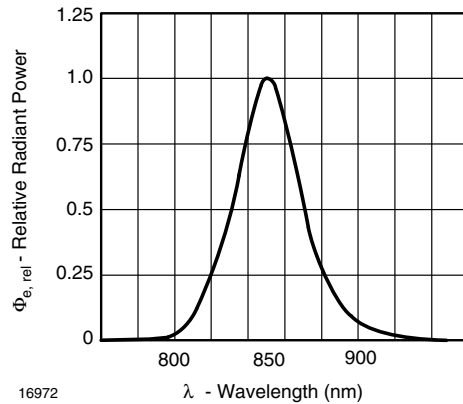

Fig. 7 - Relative Radiant Power vs. Wavelength

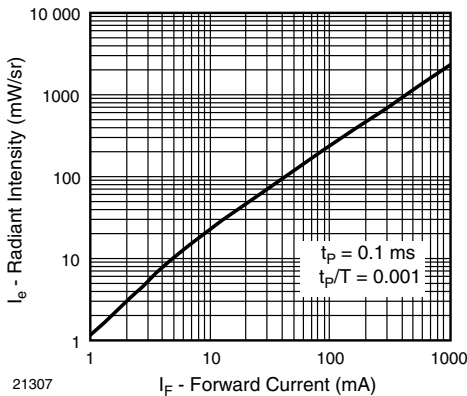

Fig. 5 - Radiant Intensity vs. Forward Current

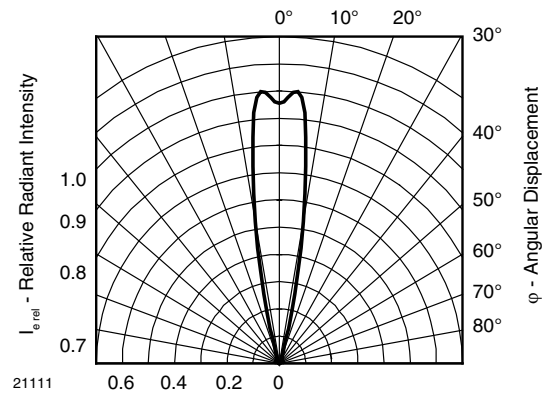
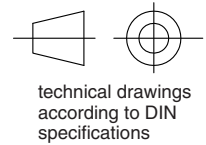
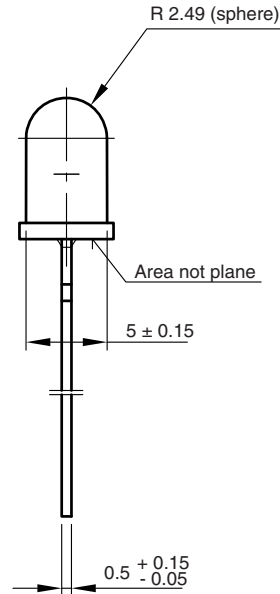
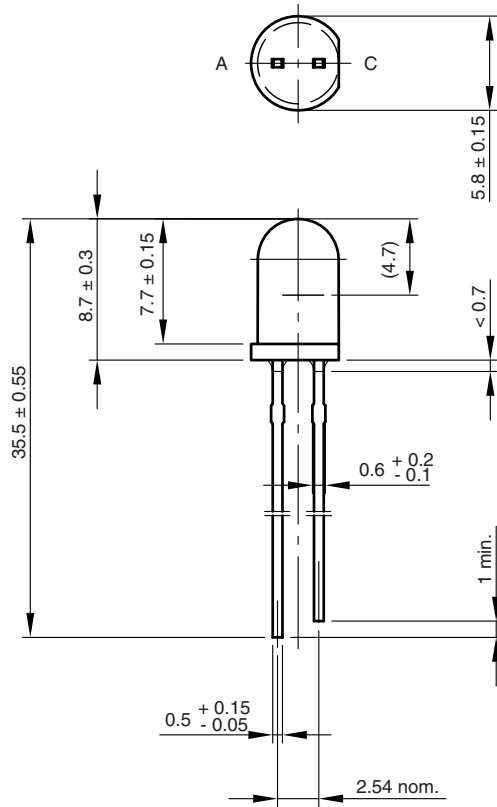

Fig. 8 - Relative Radiant Intensity vs. Angular Displacement



**PACKAGE DIMENSIONS** in millimeters



6.544-5259.02-4  
Issue: 8; 19.05.09  
95 10917



## **Disclaimer**

ALL PRODUCT, PRODUCT SPECIFICATIONS AND DATA ARE SUBJECT TO CHANGE WITHOUT NOTICE TO IMPROVE RELIABILITY, FUNCTION OR DESIGN OR OTHERWISE.

Vishay Intertechnology, Inc., its affiliates, agents, and employees, and all persons acting on its or their behalf (collectively, "Vishay"), disclaim any and all liability for any errors, inaccuracies or incompleteness contained in any datasheet or in any other disclosure relating to any product.

Vishay makes no warranty, representation or guarantee regarding the suitability of the products for any particular purpose or the continuing production of any product. To the maximum extent permitted by applicable law, Vishay disclaims (i) any and all liability arising out of the application or use of any product, (ii) any and all liability, including without limitation special, consequential or incidental damages, and (iii) any and all implied warranties, including warranties of fitness for particular purpose, non-infringement and merchantability.

Statements regarding the suitability of products for certain types of applications are based on Vishay's knowledge of typical requirements that are often placed on Vishay products in generic applications. Such statements are not binding statements about the suitability of products for a particular application. It is the customer's responsibility to validate that a particular product with the properties described in the product specification is suitable for use in a particular application. Parameters provided in datasheets and / or specifications may vary in different applications and performance may vary over time. All operating parameters, including typical parameters, must be validated for each customer application by the customer's technical experts. Product specifications do not expand or otherwise modify Vishay's terms and conditions of purchase, including but not limited to the warranty expressed therein.

Except as expressly indicated in writing, Vishay products are not designed for use in medical, life-saving, or life-sustaining applications or for any other application in which the failure of the Vishay product could result in personal injury or death. Customers using or selling Vishay products not expressly indicated for use in such applications do so at their own risk. Please contact authorized Vishay personnel to obtain written terms and conditions regarding products designed for such applications.

No license, express or implied, by estoppel or otherwise, to any intellectual property rights is granted by this document or by any conduct of Vishay. Product names and markings noted herein may be trademarks of their respective owners.