

Switched-Capacitor Voltage Doublers

General Description

The ultra-small MAX1682/MAX1683 monolithic, CMOS charge-pump voltage doublers accept input voltages ranging from +2.0V to +5.5V. Their high voltage-conversion efficiency (over 98%) and low operating current (110 μ A for MAX1682) make these devices ideal for both battery-powered and board-level voltage-doubler applications.

Oscillator control circuitry and four power MOSFET switches are included on-chip. The MAX1682 operates at 12kHz, and the MAX1683 operates at 35kHz. A typical application includes generating a 6V supply to power an LCD display in a hand-held PDA. Both parts are available in a 5-pin SOT23 package and can deliver 30mA with a typical voltage drop of 600mV.

Applications

Small LCD Panels
Cell Phones
Handy-Terminals
PDAs

Typical Operating Circuit

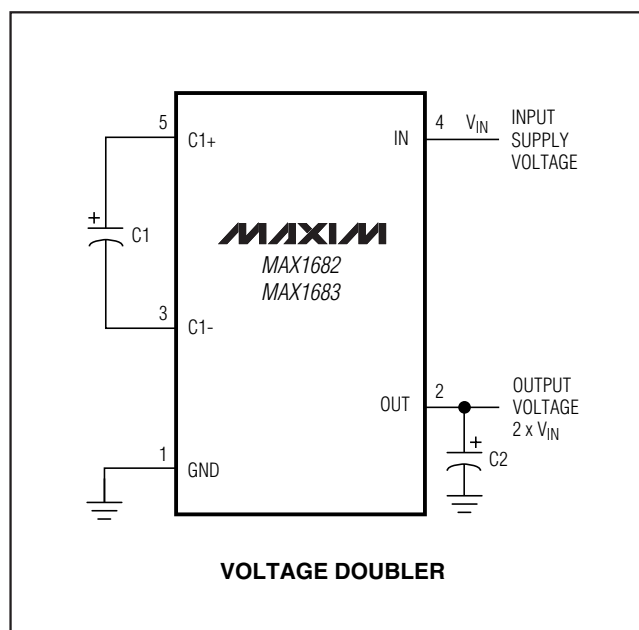

Features

- ◆ 5-Pin SOT23 Package
- ◆ +2.0V to +5.5V Input Voltage Range
- ◆ 98% Voltage-Conversion Efficiency
- ◆ 110 μ A Quiescent Current (MAX1682)
- ◆ Requires Only Two Capacitors
- ◆ Up to 45mA Output Current

Ordering Information

PART	TEMP RANGE	PIN-PACKAGE	SOT TOP MARK
MAX1682EUK+T	-40°C to +85°C	5 SOT23-5	ACCL
MAX1683EUK+T	-40°C to +85°C	5 SOT23-5	ACCM

Note: These parts are available in tape-and-reel only. Minimum order quantity is 2500 pieces.

+Denotes a lead(Pb)-free/RoHS-compliant package.

T = Tape and reel.

Pin Configuration

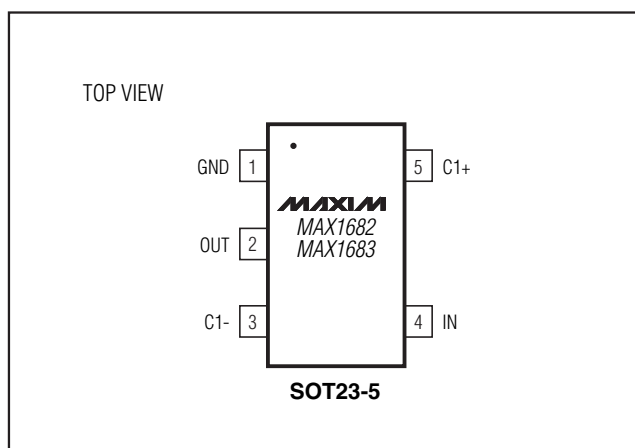

Switched-Capacitor Voltage Doublers

ABSOLUTE MAXIMUM RATINGS

IN to GND+6V to -0.3V
 OUT to GND+12V, $V_{IN} - 0.3V$
 OUT Output Current50mA
 Output Short-Circuit Duration1sec (Note 1)
 Continuous Power Dissipation ($T_A = +70^\circ C$)
 SOT23-5 (derate 7.1mW/ $^\circ C$ above $+70^\circ C$)571mW

Operating Temperature Range
 MAX1682EUK/MAX1683EUK $-40^\circ C$ to $+85^\circ C$
 Junction Temperature $+150^\circ C$
 Storage Temperature Range $-65^\circ C$ to $+160^\circ C$
 Lead Temperature (soldering, 10sec) $+300^\circ C$
 Soldering Temperature (reflow) $+260^\circ C$

Note 1: Avoid shorting OUT to GND, as it may damage the device. For temperatures above $+85^\circ C$, shorting OUT to GND even instantaneously will damage the device.

Stresses beyond those listed under "Absolute Maximum Ratings" may cause permanent damage to the device. These are stress ratings only, and functional operation of the device at these or any other conditions beyond those indicated in the operational sections of the specifications is not implied. Exposure to absolute maximum rating conditions for extended periods may affect device reliability.

ELECTRICAL CHARACTERISTICS

($V_{IN} = +5.0V$, capacitor values from Table 2, $T_A = 0^\circ C$ to $+85^\circ C$, unless otherwise noted. Typical values are at $T_A = +25^\circ C$.)

PARAMETER	CONDITIONS		MIN	TYP	MAX	UNITS
No-Load Supply Current	$T_A = +25^\circ C$	MAX1682		110	145	μA
		MAX1683		230	310	
Supply Voltage Range	$R_{LOAD} = 10k\Omega$	$T_A = +25^\circ C$	2.0	1.7	5.5	V
		$T_A = 0^\circ C$ to $+85^\circ C$	2.1	1.8	5.5	
Minimum Operating Voltage	(Note 2)			1		V
Oscillator Frequency	$T_A = +25^\circ C$	MAX1682	8.4	12	15.6	kHz
		MAX1683	24.5	35	45.5	
Output Resistance	$I_{OUT} = 5mA$	$T_A = +25^\circ C$		20	50	Ω
		$T_A = 0^\circ C$ to $+85^\circ C$			65	
Voltage Conversion Efficiency	$I_{OUT} = 0mA$, $T_A = +25^\circ C$		98	99.9		%

Note 2: Once started, the MAX1682/MAX1683 typically operate down to 1V.

ELECTRICAL CHARACTERISTICS

($V_{IN} = +5.0V$, capacitor values from Table 2, $T_A = -40^\circ C$ to $+85^\circ C$, unless otherwise noted.) (Note 3)

PARAMETER	CONDITIONS		MIN	TYP	MAX	UNITS
No-Load Supply Current	MAX1682				160	μA
	MAX1683				350	
Supply Voltage Range	$R_{LOAD} = 10k\Omega$		2.3		5.5	V
Oscillator Frequency	MAX1682		6.6		18.6	kHz
	MAX1683		17.5		57.8	
Output Resistance	$I_{OUT} = 5mA$				65	Ω
Voltage Conversion Efficiency	$I_{OUT} = 0mA$		97			%

Note 3: Specifications at $-40^\circ C$ to $+85^\circ C$ are guaranteed by design.

Switched-Capacitor Voltage Doublers

Typical Operating Characteristics

(Typical Operating Circuit, $V_{IN} = +5V$, $C_1 = C_2 = 10\mu F$ for the MAX1682 and $3.3\mu F$ for the MAX1683, $T_A = +25^\circ C$, unless otherwise noted.)

MAX1682/MAX1683

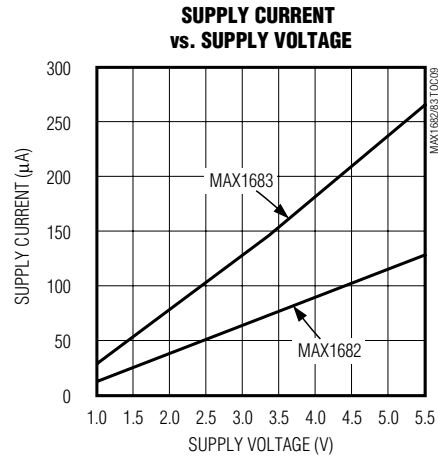
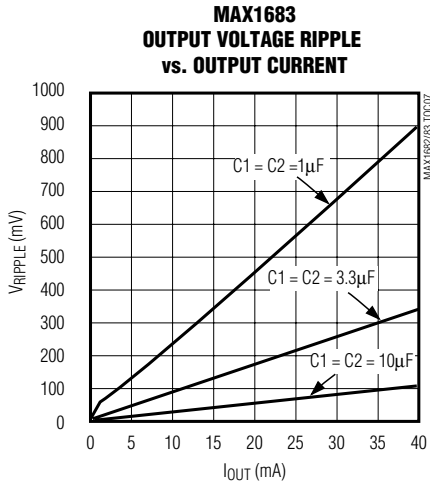
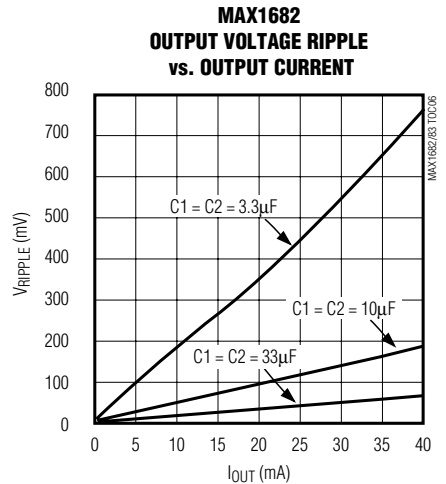
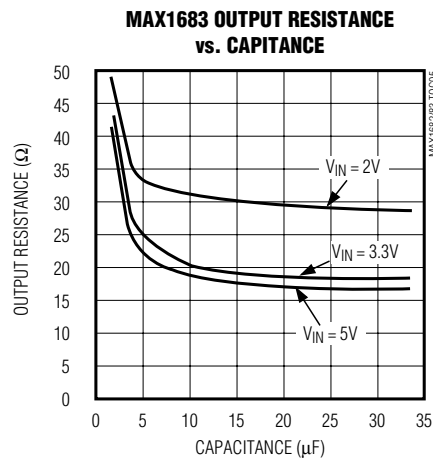
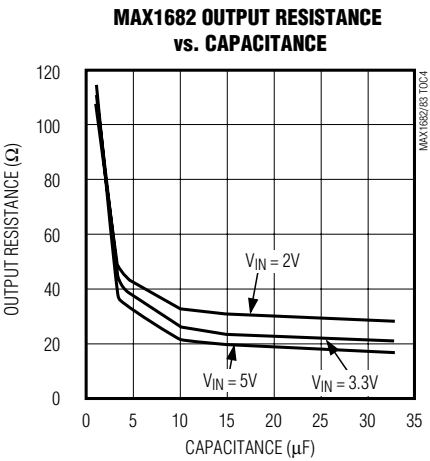
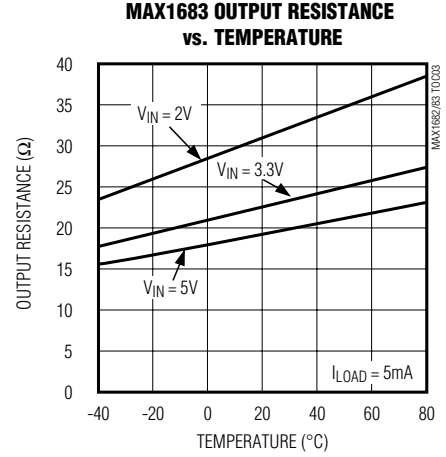
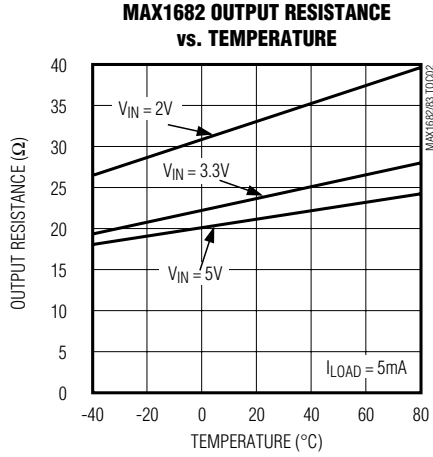
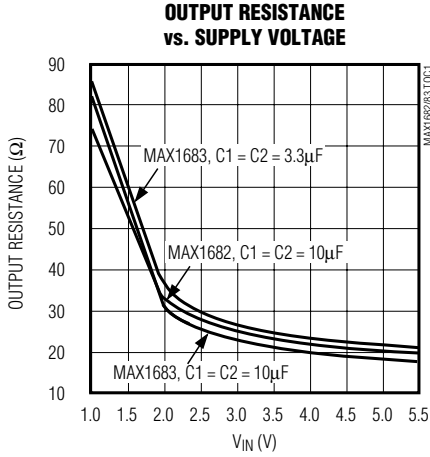

Switched-Capacitor Voltage Doublers

Typical Operating Characteristics (continued)

(Typical Operating Circuit, $V_{IN} = +5V$, $C_1 = C_2 = 10\mu F$ for the MAX1682 and $3.3\mu F$ for the MAX1683, $T_A = +25^\circ C$, unless otherwise noted.)

MAX1682 OSCILLATOR FREQUENCY vs. TEMPERATURE

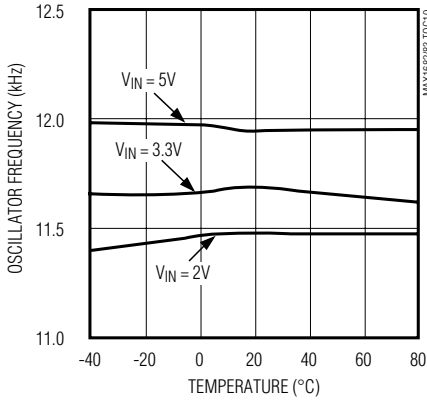

MAX1683 OSCILLATOR FREQUENCY vs. TEMPERATURE

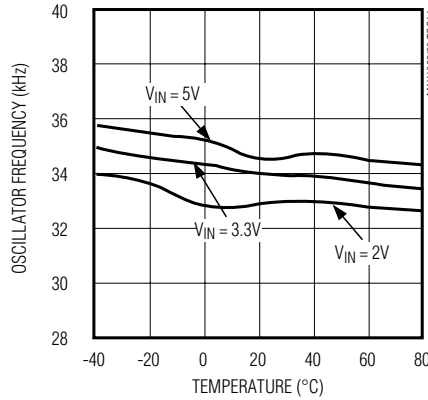

MAX1682 OUTPUT VOLTAGE vs. OUTPUT CURRENT

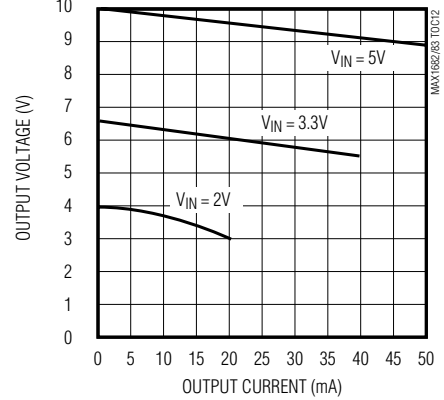

MAX1683 OUTPUT VOLTAGE vs. OUTPUT CURRENT

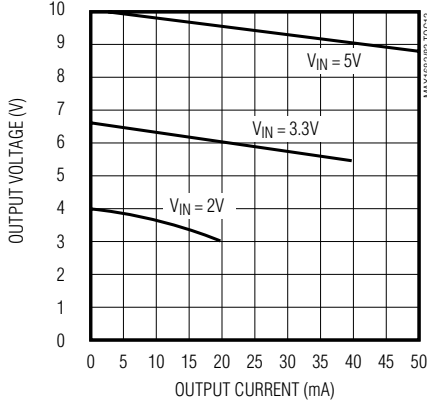

MAX1682 EFFICIENCY vs. LOAD CURRENT

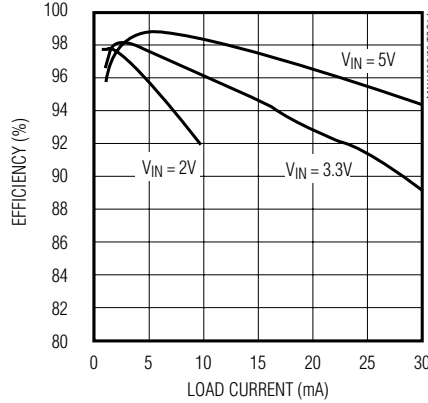

MAX1683 EFFICIENCY vs. LOAD CURRENT

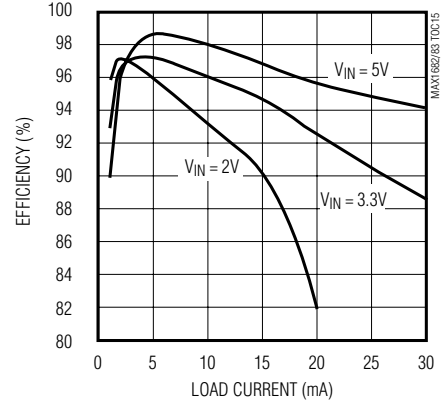

MAX1682 OUTPUT RIPPLE

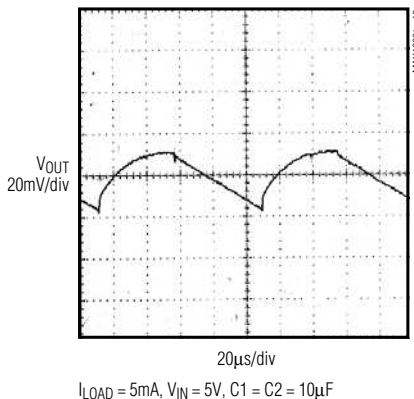

MAX1683 OUTPUT RIPPLE

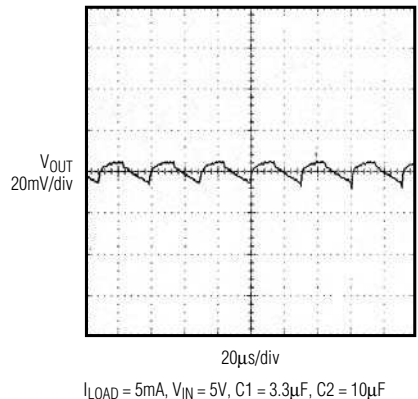

START-UP VOLTAGE vs. RESISTIVE LOAD

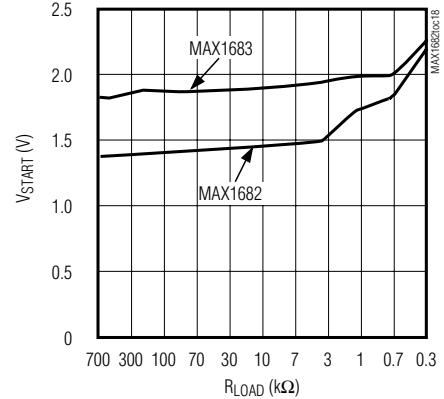

Switched-Capacitor Voltage Doublers

Pin Description

PIN	NAME	FUNCTION
1	GND	Ground
2	OUT	Doubled Output Voltage. Connect C2 between OUT and GND.
3	C1-	Negative Terminal of the Flying Capacitor
4	IN	Input Supply
5	C1+	Positive Terminal of the Flying Capacitor

Detailed Description

The MAX1682/MAX1683 capacitive charge pumps double the voltage applied to their input. Figure 1 shows a simplified functional diagram of an ideal voltage doubler. During the first half-cycle, switches S1 and S2 close, and capacitor C1 charges to V_{IN} . During the second half cycle, S1 and S2 open, S3 and S4 close, and C1 is level shifted upward by V_{IN} volts. This connects C1 to the reservoir capacitor C2, allowing energy to be delivered to the output as necessary. The actual voltage is slightly lower than $2 \times V_{IN}$, since switches S1–S4 have resistance and the load drains charge from C2.

Charge-Pump Output

The MAX1682/MAX1683 have a finite output resistance of about 20Ω (Table 2). As the load current increases, the devices' output voltage (V_{OUT}) droops. The droop equals the current drawn from V_{OUT} times the circuit's output impedance (R_S), as follows:

$$V_{DROOP} = I_{OUT} \times R_S$$

$$V_{OUT} = 2 \times V_{IN} - V_{DROOP}$$

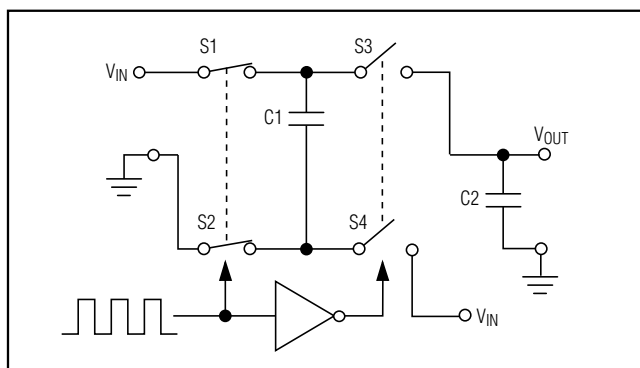

Figure 1. Simplified Functional Diagram of Ideal Voltage Doubler

Efficiency Considerations

The power efficiency of a switched-capacitor voltage converter is affected by three factors: the internal losses in the converter IC, the resistive losses of the capacitors, and the conversion losses during charge transfer between the capacitors. The total power loss is:

$$\Sigma P_{LOSS} = P_{INTERNAL\ LOSSES} + P_{PUMP\ CAPACITOR\ LOSSES} + P_{CONVERSION\ LOSSES}$$

The internal losses are associated with the IC's internal functions, such as driving the switches, oscillator, etc. These losses are affected by operating conditions such as input voltage, temperature, and frequency.

The next two losses are associated with the voltage converter circuit's output resistance. Switch losses occur because of the on-resistance of the MOSFET switches in the IC. Charge-pump capacitor losses occur because of their ESR. The relationship between these losses and the output resistance is as follows:

$$P_{PUMP\ CAPACITOR\ LOSSES} + P_{SWITCH\ LOSSES} = I_{OUT}^2 \times R_{OUT}$$

$$R_{OUT} \cong \frac{1}{(f_{OSC}) \times C1} + 2R_{SWITCHES} + 4ESR_{C1} + ESR_{C2}$$

where f_{OSC} is the oscillator frequency. The first term is the effective resistance from an ideal switched-capacitor circuit (Figures 2a and 2b).

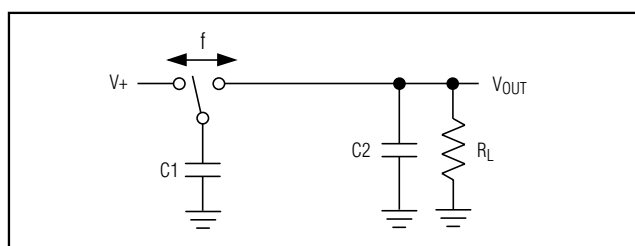

Figure 2a. Switched-Capacitor Model

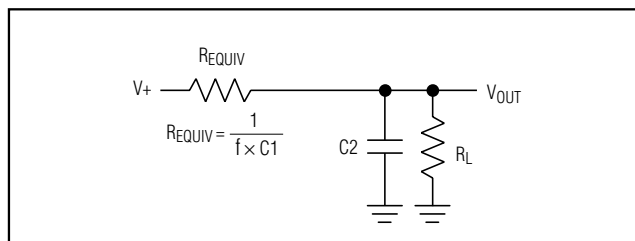

Figure 2b. Equivalent Circuit

Switched-Capacitor Voltage Doublers

Conversion losses occur during the charge transfer between C1 and C2 when there is a voltage difference between them. The power loss is:

$$P_{\text{CONVERSION LOSS}} = \left[\frac{1}{2}C1 \left(4V_{\text{IN}}^2 - V_{\text{OUT}}^2 \right) + \frac{1}{2}C2 \left(2V_{\text{OUT}}V_{\text{RIPPLE}} - V_{\text{RIPPLE}}^2 \right) \right] \times f_{\text{OSC}}$$

where V_{RIPPLE} is the peak-to-peak output voltage ripple determined by the output capacitor and load current (see *Output Capacitor* section). Choose capacitor values that decrease the output resistance (see *Flying Capacitor* section).

Applications Information

Flying Capacitor (C1)

To maintain the lowest output resistance, use capacitors with low ESR. Suitable capacitor manufacturers are listed in Table 1. The charge-pump output resistance is a function of C1 and C2's ESR and the internal switch resistance, as shown in the equation for R_{OUT} in the *Efficiency Considerations* section.

Minimizing the charge-pump capacitor's ESR minimizes the total resistance. Suggested values are listed in Tables 2 and 3.

Using a larger flying capacitor reduces the output impedance and improves efficiency (see the *Efficiency Considerations* section). Above a certain point, increasing C1's capacitance has a negligible effect because the output resistance becomes dominated by the internal switch resistance and capacitor ESR (see the *Output Resistance vs. Capacitance* graph in the *Typical Operating Characteristics*). Table 2 lists the most desirable capacitor values—those that produce a low output resistance. But when space is a constraint, it may be necessary to sacrifice low output resistance for the sake of small capacitor size. Table 3 demonstrates how the capacitor affects output resistance.

Output Capacitor (C2)

Increasing the output capacitance reduces the output ripple voltage. Decreasing its ESR reduces both output resistance and ripple. Smaller capacitance values can be used with light loads. Use the following equation to calculate the peak-to-peak ripple:

$$V_{\text{RIPPLE}} = I_{\text{OUT}} / (f_{\text{OSC}} \times C2) + 2 \times I_{\text{OUT}} \times \text{ESR}_{C2}$$

Input Bypass Capacitor

Bypass the incoming supply to reduce its AC impedance and the impact of the MAX1682/MAX1683's switching noise. When loaded, the circuit draws a continuous current of $2 \times I_{\text{OUT}}$. A 0.1 μF bypass capacitor is sufficient.

Table 1. Recommended Capacitor Manufacturers

PRODUCTION METHOD	MANUFACTURER	SERIES	PHONE	FAX
Surface-Mount Tantalum	AVX	TPS	803-946-0690	803-448-2170
	Matsuo	267	714-969-2491	714-960-6492
	Sprague	593D, 595D	603-224-1961	603-224-1430
Surface-Mount Ceramic	AVX	X7R	803-946-0590	803-626-3123
	Matsuo	X7R	714-969-2491	714-960-6492

Table 2. Suggested Capacitor Values for Low Output Resistance

PART	FREQUENCY (kHz)	CAPACITOR VALUE (μF)	TYPICAL R_{OUT} (Ω)
MAX1682	12	10	20
MAX1683	35	3.3	20

Table 3. Suggested Capacitor Values for Minimum Size

PART	FREQUENCY (kHz)	CAPACITOR VALUE (μF)	TYPICAL R_{OUT} (Ω)
MAX1682	12	3.3	35
MAX1683	35	1	35

Switched-Capacitor Voltage Doublers

Cascading Devices

Devices can be cascaded to produce an even larger voltage (Figure 3). The unloaded output voltage is nominally $(n + 1) \times V_{IN}$, where n is the number of voltage doublers used. This voltage is reduced by the output resistance of the first device multiplied by the quiescent current of the second. The output resistance increases when devices are cascaded. Using a two-stage doubler as an example, output resistance can be approximated as $R_{OUT} = 2 \times R_{OUT1} + R_{OUT2}$, where R_{OUT1} is the output resistance of the first stage and R_{OUT2} is the output resistance of the second stage. A typical value for a two-stage voltage doubler is 60Ω (with $C1$ at $10\mu\text{F}$ for MAX1682 and $3.3\mu\text{F}$ for MAX1683). For n stages with the same $C1$ value, $R_{OUT} = (2^n - 1) \times R_{OUT1}$.

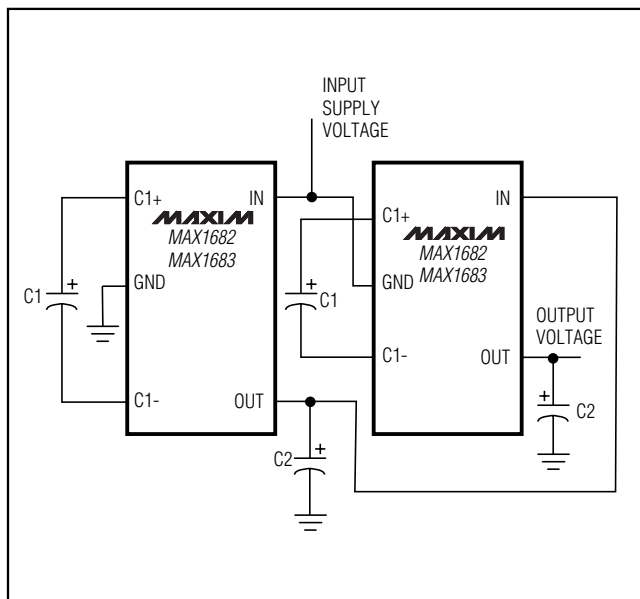

Figure 3. Cascading Devices

Paralleling Devices

Paralleling multiple MAX1682 or MAX1683s reduces the output resistance. Each device requires its own pump capacitor ($C1$), but the reservoir capacitor ($C2$) serves all devices (Figure 4). Increase $C2$'s value by a factor of n , where n is the number of parallel devices. Figure 4 shows the equation for calculating output resistance.

Layout and Grounding

Good layout is important, primarily for good noise performance. To ensure good layout, mount all components as close together as possible, keep traces short to minimize parasitic inductance and capacitance, and use a ground plane.

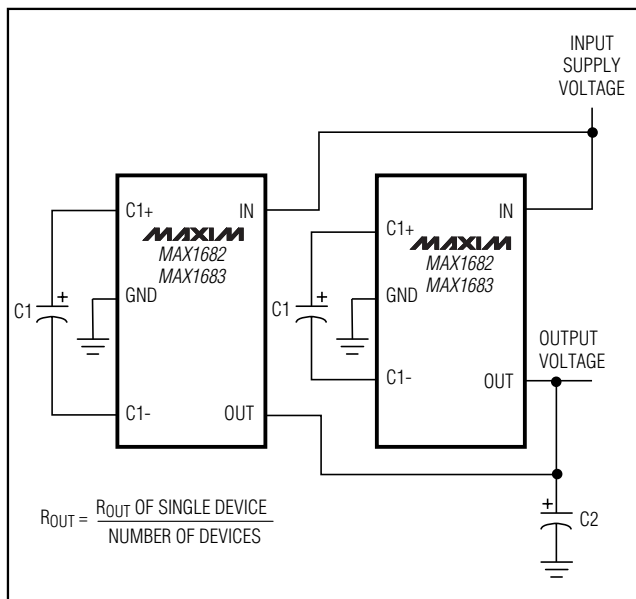

Figure 4. Paralleling Devices

Switched-Capacitor Voltage Doublers

Package Information

For the latest package outline information and land patterns, go to www.maxim-ic.com/packages. Note that a "+", "#", or "-" in the package code indicates RoHS status only. Package drawings may show a different suffix character, but the drawing pertains to the package regardless of RoHS status.

PACKAGE TYPE	PACKAGE CODE	OUTLINE NO.	LAND PATTERN NO.
5 SOT23	U5+2	21-0057	90-0174

TOP VIEW

SIDE VIEW

FRONT VIEW

SYMBOL	MIN	NDM	MAX
A	0.90	1.25	1.45
A1	0.00	0.05	0.15
A2	0.90	1.10	1.30
b	0.35	0.40	0.50
C	0.08	0.15	0.20
D	2.80	2.90	3.00
E	2.60	2.80	3.00
E1	1.50	1.625	1.75
L	0.35	0.45	0.60
L1	0.60 REF		
e	0.95 BSC.		
e1	1.90 BSC.		
a	0°	2.5°	8°
PKG CODES: U5-1, U5-2			

NOTES:

- ALL DIMENSIONS ARE IN MILLIMETERS.
- FOOT LENGTH MEASURED AT INTERCEPT POINT BETWEEN DATUM A & LEAD SURFACE.
- PACKAGE OUTLINE EXCLUSIVE OF MOLD FLASH & METAL BURR. MOLD FLASH, PROTRUSION OR METAL BURR SHOULD NOT EXCEED 0.25 MM.
- PACKAGE OUTLINE INCLUSIVE OF SOLDER PLATING.
- MEETS JEDEC MO17B, VARIATION AA.
- LEADS TO BE COPLANAR WITHIN 0.10 mm.
- SOLDER THICKNESS MEASURED AT FLAT SECTION OF LEAD BETWEEN 0.08mm AND 0.15mm FROM LEAD TIP.

DALLAS SEMICONDUCTOR **MAXIM**

PROPRIETARY INFORMATION

TITLE: PACKAGE OUTLINE, SOT-23, 5L

APPROVAL	DOCUMENT CONTROL NO. 21-0057	REV. F	1/1
----------	---------------------------------	-----------	-----

SOT-23 5L.EPS

Switched-Capacitor Voltage Doublers

Revision History

REVISION NUMBER	REVISION DATE	DESCRIPTION	PAGES CHANGED
3	11/10	Added lead-free parts	1

Maxim cannot assume responsibility for use of any circuitry other than circuitry entirely embodied in a Maxim product. No circuit patent licenses are implied. Maxim reserves the right to change the circuitry and specifications without notice at any time.

9 **Maxim Integrated Products, 120 San Gabriel Drive, Sunnyvale, CA 94086 408-737-7600**

© 2010 Maxim Integrated Products

Maxim is a registered trademark of Maxim Integrated Products.