

TIP42

Rev.F Mar.-2016

描述 / Descriptions

TO-220 塑封封装 PNP 半导体三极管。Silicon PNP transistor in a TO-220 Plastic Package.

特征 / Features

与 TIP41 互补。
Complement to TIP41.

用途 / Applications

用于中功率线性开关放大。
Medium power linear switching applications.

内部等效电路 / Equivalent Circuit

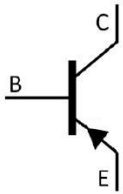

引脚排列 / Pinning

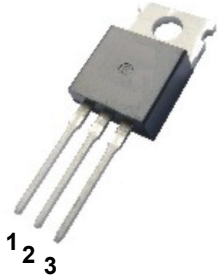

PIN1 : Base PIN 2 : Collector PIN 3 : Emitter

放大及印章代码 / h_{FE} Classifications & Marking

见印章说明。See Marking Instructions.

极限参数 / Absolute Maximum Ratings(Ta=25°C)

参数 Parameter	符号 Symbol	数值 Rating				单位 Unit
		TIP42	TIP42A	TIP42B	TIP42C	
Collector to Base Voltage	V_{CBO}	-40	-60	-80	-100	V
Collector to Emitter Voltage	V_{CEO}	-40	-60	-80	-100	V
Emitter to Base Voltage	V_{EBO}	-5.0				V
Collector Current - Continuous	I_C	-6.0				A
Peak Collector Current	I_{CP}	-10				A
Base Current - Continuous	I_B	-2.0				A
Collector Power Dissipation	P_C	2.0				W
Collector Power Dissipation	$P_C(T_C=25^\circ\text{C})$	65				W
Junction Temperature	T_j	150				°C
Storage Temperature Range	T_{sag}	-55~150				°C

电性能参数 / Electrical Characteristics(Ta=25°C)

参数 Parameter	符号 Symbol	测试条件 Test Conditions	最小值 Min	典型值 Typ	最大值 Max	单位 Unit
Collector to Emitter Breakdown Voltage	V_{CEO}	TIP42	$I_C=-30\text{mA}$	$I_B=0$		V
		TIP42A				
		TIP42B				
		TIP42C				
Collector Cut-Off Current	I_{CEO}	TIP42 TIP42A	$V_{CE}=-30\text{V}$	$I_B=0$	-0.7	mA
		TIP42B TIP42C	$V_{CE}=-60\text{V}$	$I_B=0$		
Collector Cut-Off Current	I_{CES}	TIP42	$V_{CE}=-40\text{V}$	$V_{EB}=0$	-400	μA
		TIP42A	$V_{CE}=-60\text{V}$	$V_{EB}=0$		
		TIP42B	$V_{CE}=-80\text{V}$	$V_{EB}=0$		
		TIP42C	$V_{CE}=-100\text{V}$	$V_{EB}=0$		
Emitter Cut-Off Current	I_{EBO}	$V_{EB}=-5.0\text{V}$	$I_C=0$		-1.0	mA
DC Current Gain	$h_{FE(1)}$	$V_{CE}=-4.0\text{V}$	$I_C=-3.0\text{A}$	15	75	
	$h_{FE(2)}$	$V_{CE}=-4.0\text{V}$	$I_C=-0.3\text{A}$	30		
Collector to Emitter Saturation Voltage	$V_{CE(\text{sat})}$	$I_C=-6.0\text{A}$	$I_B=-0.6\text{A}$		-1.5	V
Base to Emitter Voltage	V_{BE}	$I_C=-6.0\text{A}$	$V_{CE}=-4.0\text{V}$		-2.0	V
Transition Frequency	f_T	$V_{CE}=-10\text{V}$	$I_C=-500\text{mA}$	3.0		MHz

电参数曲线图 / Electrical Characteristic Curve

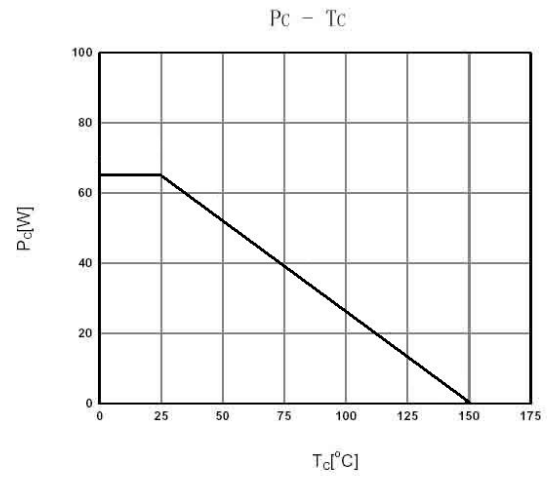
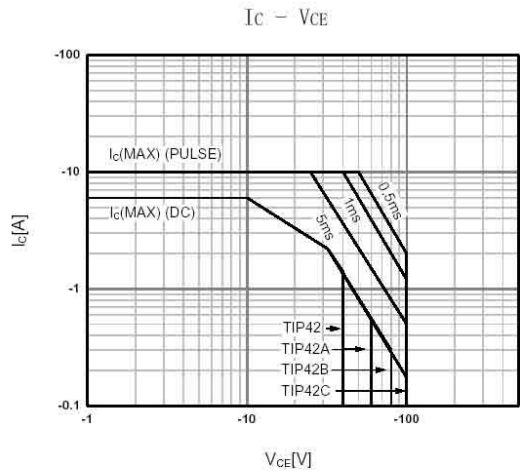
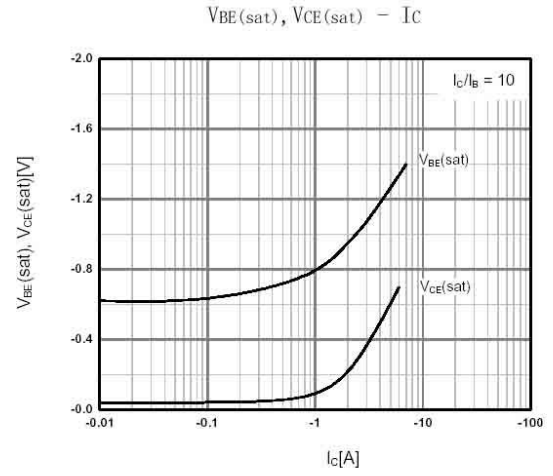
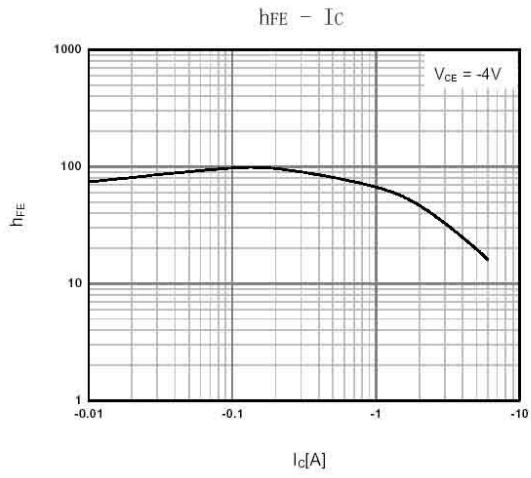

外形尺寸图 / Package Dimensions

T0-220

单位: mm

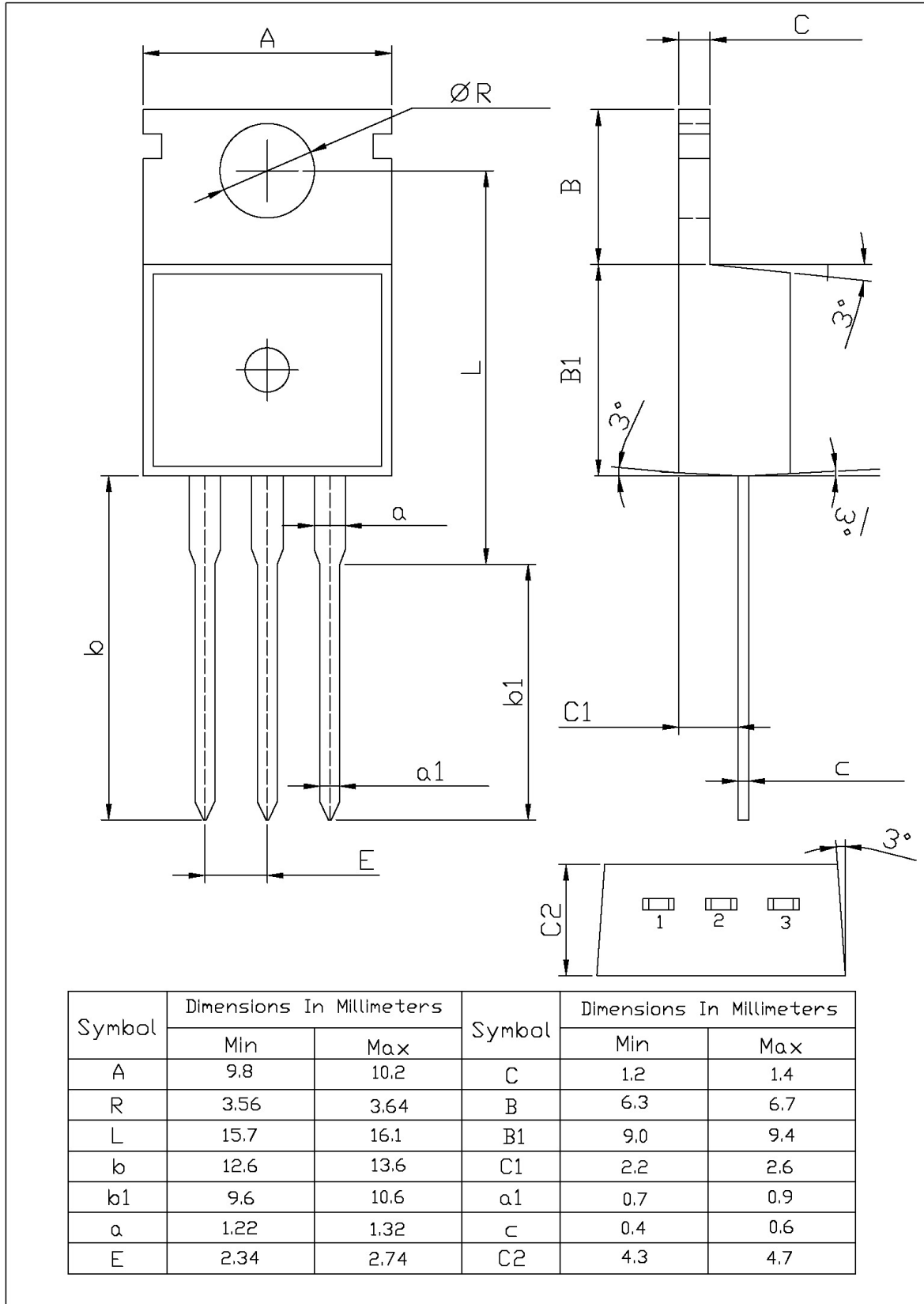

印章说明 / Marking Instructions

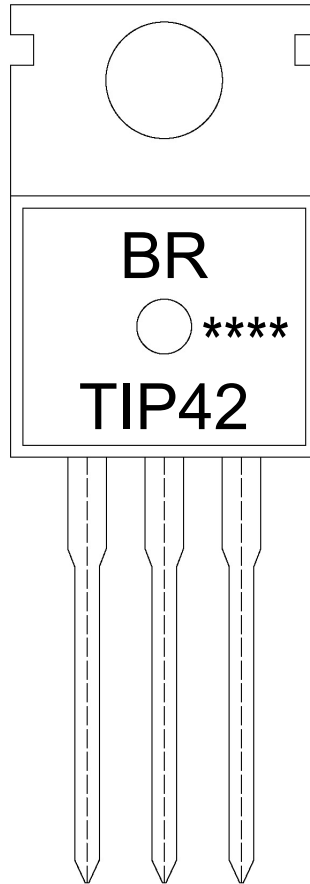

说明：

BR： 为公司代码

TIP42： 为产品型号

****： 为生产批号代码，随生产批号变化。

Note:

BR: Company Code

TIP42: Product Type.

****: Lot No. Code, code change with Lot No.

波峰焊温度曲线图(无铅) / Temperature Profile for Dip Soldering(Pb-Free)



说明：

- 1、预热温度 25 ~ 150°C，时间 60 ~ 90sec;
- 2、峰值温度 255±5°C，时间持续为 5±0.5sec;
- 3、焊接制程冷却速度为 2 ~ 10°C/sec.

Note:

- 1.Preheating:25~150°C, Time:60~90sec.
- 2.Peak Temp.:255±5°C, Duration:5±0.5sec.
3. Cooling Speed: 2~10°C/sec.

耐焊接热试验条件 / Resistance to Soldering Heat Test Conditions

温度：270±5°C

时间：10±1 sec.

Temp.:270±5°C

Time:10±1 sec

包装规格 / Packaging SPEC.

散件包装 / BULK

Package Type 封装形式	Units 包装数量					Dimension 包装尺寸 (unit: mm ³)		
	Units/Bag 只/袋	Bags/Inner Box 袋/盒	Units/Inner Box 只/盒	Inner Boxes/Outer Box 盒/箱	Units/Outer Box 只/箱	Bag 袋	Inner Box 盒	Outer Box 箱
TO-220/F	200	10	2,000	5	10,000	135×190	237×172×102	560×245×195

套管包装 / TUBE

Package Type 封装形式	Units 包装数量					Dimension 包装尺寸 (unit: mm ³)		
	Units/Tube 只/套管	Tubes/Inner Box 套管/盒	Units/Inner Box 只/盒	Inner Boxes/Outer Box 盒/箱	Units/Outer Box 只/箱	Tube 套管	Inner Box 盒	Outer Box 箱
TO-220/F	50	20	1,000	5	5,000	532×31.4×5.5	555×164×50	575×290×180

使用说明 / Notices