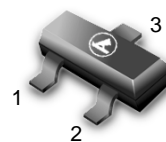
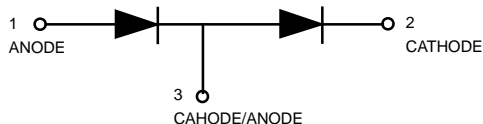

Dual Series Switching Diode

LBAV99LT1

SOT-23
DEVICE MARKING

LBAV99LT1 = A7

MAXIMUM RATINGS (EACH DIODE)

Rating	Symbol	Value	Unit
Reverse Voltage	V_R	70	Vdc
Forward Current	I_F	215	mAdc
Peak Forward Surge Current	$I_{FM(surge)}$	500	mAdc
Repetitive Peak Reverse Voltage	V_{RRM}	70	V
Average Rectified Forward Current (1) (averaged over any 20 ms period)	$I_{F(AV)}$	715	mA
Repetitive Peak Forward Current	I_{FRM}	450	mA
Non-Repetitive Peak Forward Current	I_{FSM}		A
$t = 1.0 \mu s$		2.0	
$t = 1.0 ms$		1.0	
$t = 1.0 S$		0.5	

THERMAL CHARACTERISTICS

Characteristic	Symbol	Max	Unit
Total Device Dissipation FR-5 Board, (1) $T_A = 25^\circ C$ Derate above $25^\circ C$	P_D	225 1.8	mW mW/ $^\circ C$
Thermal Resistance Junction to Ambient	$R_{\theta JA}$	556	$^\circ C/W$
Total Device Dissipation Alumina Substrate, (2) $T_A = 25^\circ C$ Derate above $25^\circ C$	P_D	300 2.4	mW mW/ $^\circ C$
Thermal Resistance Junction to Ambient	$R_{\theta JA}$	417	$^\circ C/W$
Junction and Storage Temperature	T_J, T_{stg}	-65 to +150	$^\circ C$

ELECTRICAL CHARACTERISTICS ($T_A = 25^\circ C$ unless otherwise noted) (EACH DIODE)

Characteristic	Symbol	Min	Max	Unit
----------------	--------	-----	-----	------

OFF CHARACTERISTICS

Reverse Breakdown Voltage ($I_{(BR)} = 100 \mu A$)	$V_{(BR)}$	70	—	Vdc
Reverse Voltage Leakage Current ($V_R = 70 Vdc$)	I_R	—	2.5	μA dc
($V_R = 25 Vdc, T_J = 150^\circ C$)		—	30	
($V_R = 70 Vdc, T_J = 150^\circ C$)		—	50	
Diode Capacitance ($V_R = 0, f = 1.0 MHz$)	C_D	—	1.5	pF
Forward Voltage ($I_F = 1.0 mAdc$)	V_F	—	715	mVdc
($I_F = 10 mAdc$)		—	855	
($I_F = 50 mAdc$)		—	1000	
($I_F = 150 mAdc$)		—	1250	
Reverse Recovery Time ($I_F = I_R = 10 mAdc, i_{R(REC)} = 1.0 mAdc, R_L = 100 \Omega$) (Figure 1)	t_{rr}	—	6.0	ns
Forward Recovery Voltage ($I_F = 10 mA, t_r = 20 ns$)	V_{FR}	—	1.75	V

1. FR-5 = 1.0 x 0.75 x 0.062 in.

2. Alumina = 0.4 x 0.3 x 0.024 in. 99.5% alumina.

LBAV99LT1

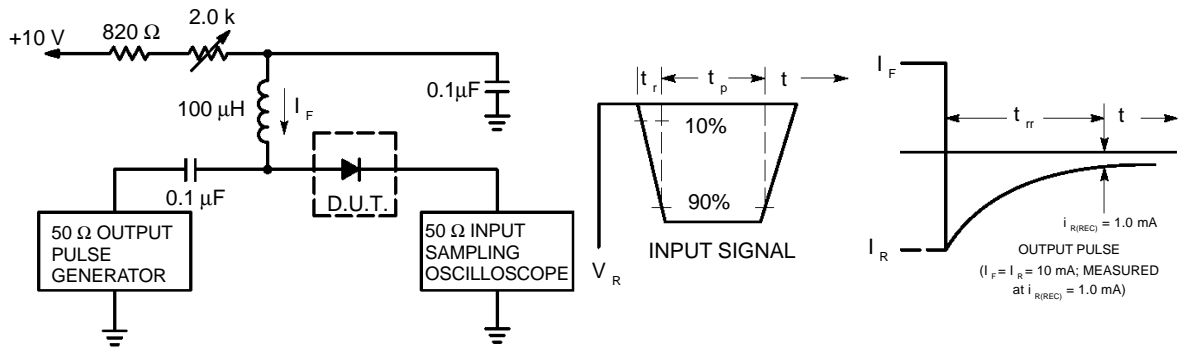

- Notes: 1. A 2.0 kΩ variable resistor adjusted for a Forward Current (I_F) of 10mA.
- 2. Input pulse is adjusted so $I_{R(peak)}$ is equal to 10mA.
- 3. $t_p \gg t_{rr}$

Figure 1. Recovery Time Equivalent Test Circuit

CURVES APPLICABLE TO EACH DIODE

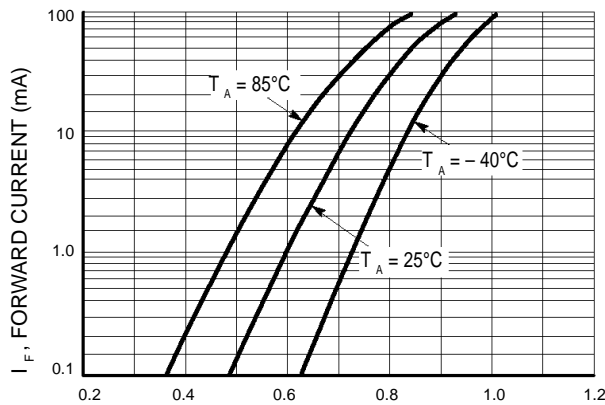

Figure 2. Forward Voltage

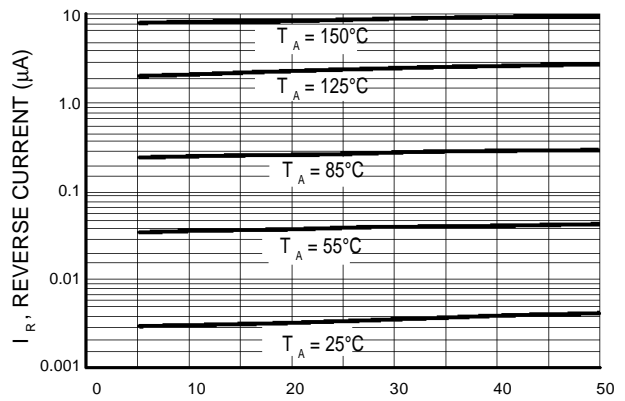

Figure 3. Leakage Current

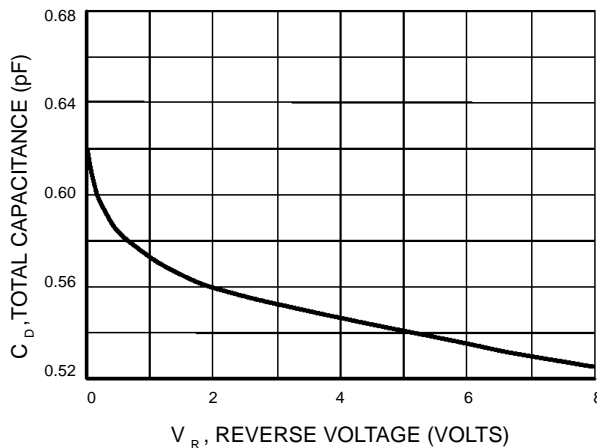
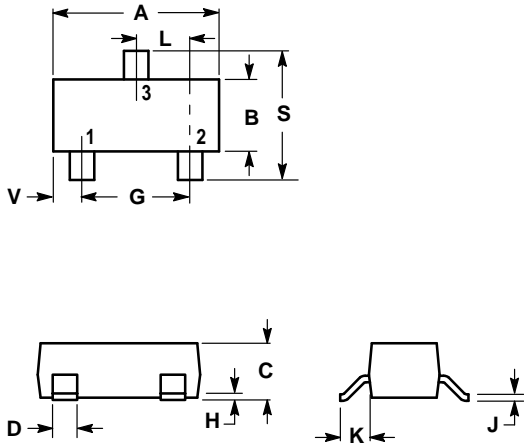

Figure 4. Capacitance

LBAV99LT1

SOT-23



NOTES:

1. DIMENSIONING AND TOLERANCING PER ANSI Y14.5M, 1982.
2. CONTROLLING DIMENSION: INCH.

DIM	INCHES		MILLIMETERS	
	MIN	MAX	MIN	MAX
A	0.1102	0.1197	2.80	3.04
B	0.0472	0.0551	1.20	1.40
C	0.0350	0.0440	0.89	1.11
D	0.0150	0.0200	0.37	0.50
G	0.0701	0.0807	1.78	2.04
H	0.0005	0.0040	0.013	0.100
J	0.0034	0.0070	0.085	0.177
K	0.0140	0.0285	0.35	0.69
L	0.0350	0.0401	0.89	1.02
S	0.0830	0.1039	2.10	2.64
V	0.0177	0.0236	0.45	0.60

- PIN 1. ANODE
 2. CAHODE
 3. CAHODE/ANODE

