

描述 / Descriptions

TO-92LM 塑封封装 PNP 半导体三极管。Silicon PNP transistor in a TO-92LM Plastic Package.

特征 / Features

击穿电压高,反向传输电容小,高频特性好。

High breakdown voltage, small reverse transfer capacitance and excellent high frequency characteristic.

用途 / Applications

用于彩电行输出和高击穿电压驱动。

Color TV chroma output and high breakdown voltage driver.

内部等效电路 / Equivalent Circuit

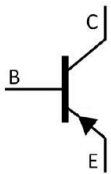

引脚排列 / Pinning



PIN 1 : Base PIN 2 : Collector PIN 3 : Emitter

放大及印章代码 / h_{FE} Classifications & Marking

| h_{FE} Classifications Symbol | C | D | E | F |
|------------------------------------|-------|--------|---------|---------|
| h_{FE} Range | 40~80 | 60~120 | 100~200 | 160~320 |

极限参数 / Absolute Maximum Ratings(Ta=25°C)

| 参数 Parameter | 符号 Symbol | 数值 Rating | 单位 Unit |
|---------------------------------------|--------------|--------------|------------|
| Collector to Base Voltage | V_{CBO} | -300 | V |
| Collector to Emitter Voltage | V_{CEO} | -300 | V |
| Emitter to Base Voltage | V_{EBO} | -5.0 | V |
| Collector Current - Continuous | I_C | -100 | mA |
| Collector Current – Continuous(Pulse) | I_{CP} | -200 | mA |
| Collector Power Dissipation | P_C | 1.0 | W |
| Junction Temperature | T_j | 150 | °C |
| Storage Temperature Range | T_{stg} | -55~150 | °C |

电性能参数 / Electrical Characteristics(Ta=25°C)

| 参数 Parameter | 符号 Symbol | 测试条件 Test Conditions | 最小值 Min | 典型值 Typ | 最大值 Max | 单位 Unit |
|---|---------------|------------------------------|------------|------------|------------|------------|
| Collector to Base Breakdown Voltage | V_{CBO} | $I_C=-10\mu A$ $I_E=0$ | -300 | | | V |
| Collector to Emitter Breakdown Voltage | V_{CEO} | $I_C=-1.0mA$ $R_{BE}=\infty$ | -300 | | | V |
| Emitter to Base Breakdown Voltage | V_{EBO} | $I_E=-10\mu A$ $I_C=0$ | -5.0 | | | V |
| Collector Cut-Off Current | I_{CBO} | $V_{CB}=-200V$ $I_E=0$ | | | -0.1 | μA |
| Emitter Cut-Off Current | I_{EBO} | $V_{EB}=-4.0V$ $I_C=0$ | | | -0.1 | μA |
| DC Current Gain | h_{FE} | $V_{CE}=-10V$ $I_C=-10mA$ | 40 | | 320 | |
| Collector to Emitter Saturation Voltage | $V_{CE(sat)}$ | $I_C=-20mA$ $I_B=-2.0mA$ | | | -0.6 | V |
| Base to Emitter Saturation Voltage | $V_{BE(sat)}$ | $I_C=-20mA$ $I_B=-2.0mA$ | | | -1.0 | V |
| Transition Frequency | f_T | $V_{CE}=-30V$ $I_C=-10mA$ | | 150 | | MHz |
| Collector output capacitance | C_{ob} | $V_{CB}=-30V$ $f=1.0MHz$ | | 3.1 | | pF |
| Reverse Transfer Capacitance | C_{re} | $V_{CB}=-30V$ $f=1.0MHz$ | | 2.3 | | pF |

电参数曲线图 / Electrical Characteristic Curve

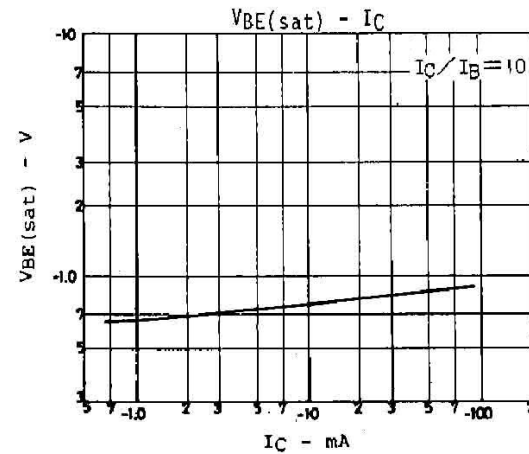
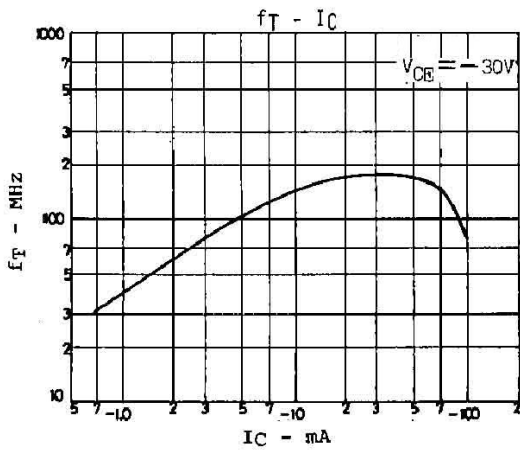
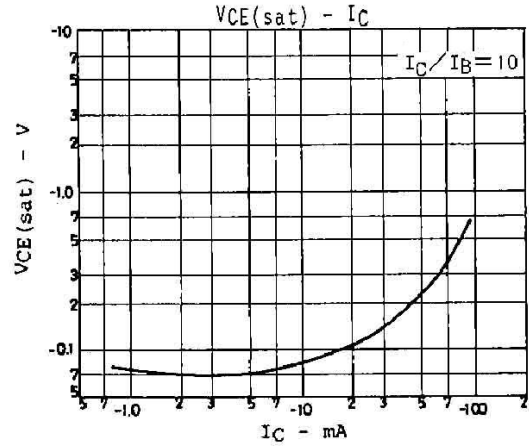
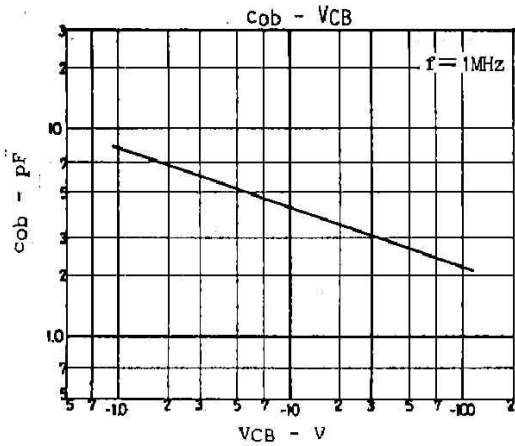
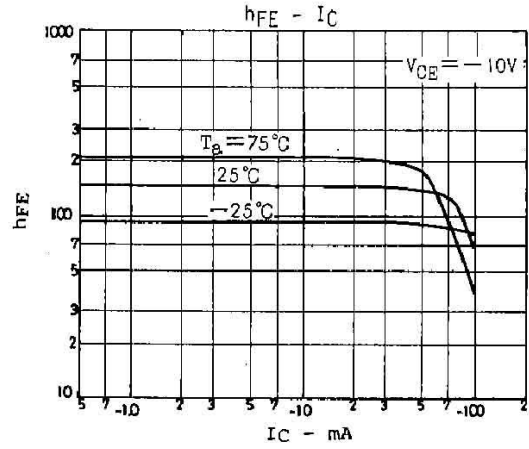
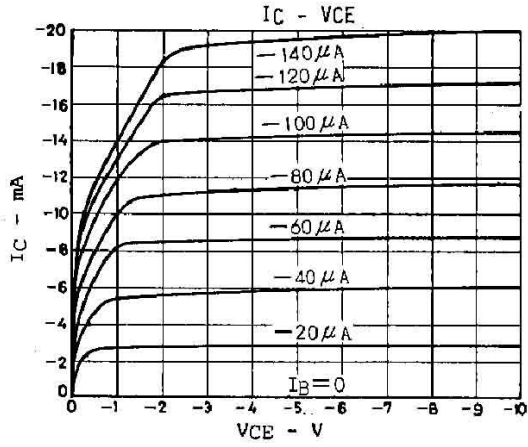

外形尺寸图 / Package Dimensions

T0-92LM

Unit: mm

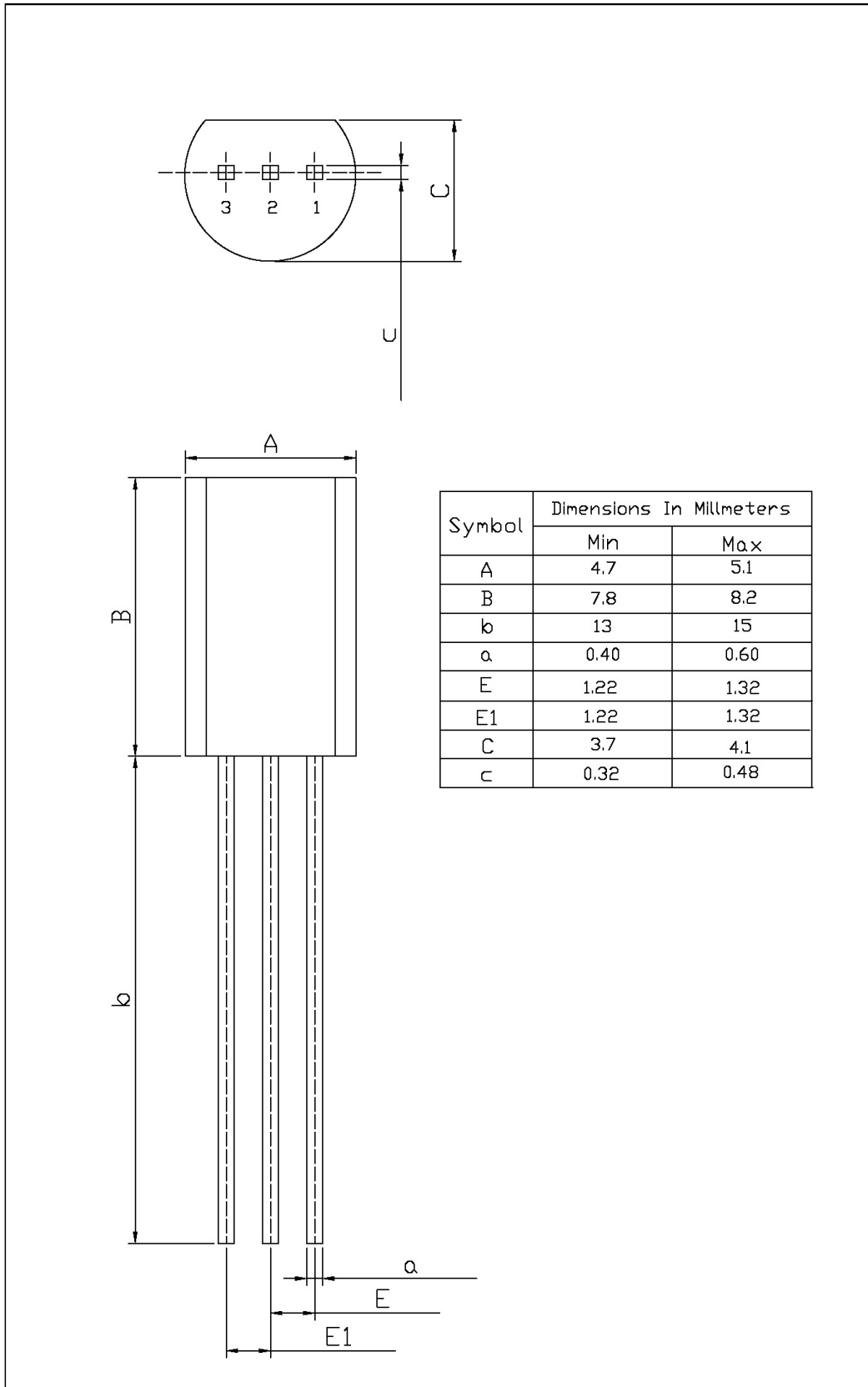

印章说明 / Marking Instructions

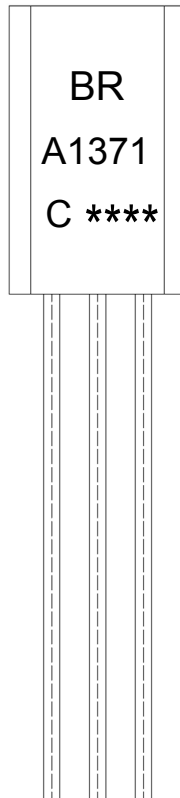

说明：

BR: 为公司代码
A1371 : 为型号代码
C: 为 h_{FE} 分档代码
**** : 为生产批号代码，随生产批号变化。

Note:

BR: Company Code.
A1371: Product Type.
C: h_{FE} Classifications Symbol
****: Lot No. Code,code change with Lot No.

波峰焊温度曲线图(无铅) / Temperature Profile for Dip Soldering(Pb-Free)



说明：

- 1、预热温度 25 ~ 150°C，时间 60 ~ 90sec;
- 2、峰值温度 255±5°C，时间持续为 5±0.5sec;
- 3、焊接制程冷却速度为 2 ~ 10°C/sec.

Note:

- 1.Preheating:25~150°C, Time:60~90sec.
- 2.Peak Temp.:255±5°C, Duration:5±0.5sec.
3. Cooling Speed: 2~10°C/sec.

耐焊接热试验条件 / Resistance to Soldering Heat Test Conditions

温度：270±5°C 时间：10±1 sec. Temp.:270±5°C Time:10±1 sec

包装规格 / Packaging SPEC.

散件包装 / BULK

| Package Type 封装形式 | Units 包装数量 | | | | | Dimension 包装尺寸 (unit: mm3) | | |
|----------------------|------------------|-----------------------|------------------------|------------------------------|------------------------|----------------------------|-------------|-------------|
| | Units/Bag 只/袋 | Bags/Inner Box 袋/盒 | Units/Inner Box 只/盒 | Inner Boxes/Outer Box 盒/箱 | Units/Outer Box 只/箱 | Bag 袋 | Inner Box 盒 | Outer Box 箱 |
| TO-92LM | 1,000 | 8 | 8,000 | 5 | 40,000 | 135×190 | 237×172×102 | 560×245×195 |

编带包装 / AMMO

| Package Type 封装形式 | Units 包装数量 | | | | | Dimension 包装尺寸 (unit: mm3) | |
|----------------------|--------------------|------------------------|-------------------------|------------------------------|------------------------|----------------------------|----------------------------------|
| | Units/tape 只/纸带 | Tape/Inner Box 纸带/盒 | Rows/Inner Box 纸带层/盒 | Inner Boxes/Outer Box 盒/箱 | Units/Outer Box 只/箱 | Inner Box 盒 | Outer Box 箱 |
| TO-92LM | 2,500 | 1 | 100 | 10 | 25,000 | 328×230×42 | 小箱 480×346×235 大箱 547×407×268 |

使用说明 / Notices