

FEATURES

- 8-channel, 24-bit simultaneous sampling ADC**
- Single-ended or true differential inputs**
- PGA per channel (gains of 1, 2, 4, and 8)**
- Low dc input current**
 - ± 4 nA (differential)/ ± 8 nA (single-ended)
- Up to 128 kSPS ODR per channel**
- Programmable ODRs and bandwidth**
- SRC for coherent sampling**
 - Sampling rate resolution up to 15.2×10^{-6} SPS
- Low latency sinc3 and sinc5 filter paths**
- Adjustable phase synchronization**
- Internal 2.5 V reference**
- Two power modes**
 - High resolution mode
 - Low power mode
- Optimizes power dissipation and performance**
- Low resolution SAR ADC for system and chip diagnostics**
- Power supply**
 - Bipolar (± 1.65 V) or unipolar (3.3 V) supplies
 - Digital I/O supply: 1.8 V to 3.6 V
 - Performance temperature range: -40°C to $+105^{\circ}\text{C}$
 - Functional temperature range: -40°C to $+125^{\circ}\text{C}$
- Performance**
 - Combined ac and dc performance
 - 107 dB SNR/dynamic range at 32 kSPS in high resolution mode (sinc5)
 - -109 dB THD
 - ± 8 ppm of FSR INL
 - ± 15 μV offset error
 - $\pm 0.1\%$ FS gain error
 - ± 10 ppm/ $^{\circ}\text{C}$ typical temperature coefficient

APPLICATIONS

- Power quality and measurement applications**
- General-purpose data acquisition**
- Electroencephalography (EEG)**
- Industrial process control**

GENERAL DESCRIPTION

The AD7771¹ is an 8-channel, simultaneous sampling analog-to-digital converter (ADC). Eight full Σ - Δ ADCs are on-chip. The AD7771 provides an ultralow input current to allow direct sensor connection. Each input channel has a programmable gain stage allowing gains of 1, 2, 4, and 8 to map lower amplitude sensor outputs into the full-scale ADC input range, maximizing the dynamic range of the signal chain. The AD7771 accepts a V_{REF}

voltage from 1 V up to 3.6 V. The analog inputs accept unipolar (0 V to V_{REF}) or true bipolar ($\pm V_{\text{REF}}/2$ V) analog input signals with 3.3 V or ± 1.65 V analog supply voltages, respectively. The analog inputs can be configured to accept true differential or single-ended signals to match different sensor output configurations.

Each channel contains an ADC modulator and a sinc3/sinc5, low latency digital filter. A sample rate converter (SRC) is provided to allow fine resolution control over the AD7771 output data rate (ODR). This control can be used in applications where the ODR resolution is required to maintain coherency with 0.01 Hz changes in the line frequency. The SRC is programmable through the serial port interface (SPI). The AD7771 implements two different interfaces: a data output interface and SPI control interface. The ADC data output interface is dedicated to transmitting the ADC conversion results from the AD7771 to the processor. The SPI writes to and reads from the AD7771 configuration registers and for the control and reading of data from the successive approximation register (SAR) ADC. The SPI can also be configured to output the Σ - Δ conversion data.

The AD7771 includes a 12-bit SAR ADC. This ADC can be used for AD7771 diagnostics without having to decommission one of the Σ - Δ ADC channels dedicated to system measurement functions. With the use of an external multiplexer, which can be controlled through the three general-purpose input/output pins (GPIOs), and signal conditioning, the SAR ADC can validate the Σ - Δ ADC measurements in applications where functional safety is required. In addition, the AD7771 SAR ADC includes an internal multiplexer to sense internal nodes.

The AD7771 contains a 2.5 V reference and reference buffer. The reference has a typical temperature coefficient of ± 10 ppm/ $^{\circ}\text{C}$.

The AD7771 offers two modes of operation: high resolution mode and low power mode. High resolution mode provides a higher dynamic range while consuming 16.6 mW per channel; low power mode consumes only 5.25 mW per channel at a reduced dynamic range specification.

The specified operating temperature range is -40°C to $+105^{\circ}\text{C}$, although the device is operational up to $+125^{\circ}\text{C}$.

Note that throughout this data sheet, certain terms are used to refer to either the multifunction pins or a range of pins. The multifunction pins, such as DCLK0/SDO, are referred to either by the entire pin name or by a single function of the pin, for example, DCLK0, when only that function is relevant. In the case of ranges of pins, AVSSx refers to the following pins: AVSS1A, AVSS1B, AVSS2A, AVSS2B, AVSS3, and AVSS4.

¹ This product is protected by at least U.S. Patent No. 9,432,043.

AD7771* PRODUCT PAGE QUICK LINKS

Last Content Update: 07/28/2017

COMPARABLE PARTS

View a parametric search of comparable parts.

EVALUATION KITS

- AD7770 / AD7771 / AD7779 Evaluation Board
- AD7771 Evaluation Board

DOCUMENTATION

Application Notes

- AN-1388: Coherent Sampling for Power Quality Measurements Using the AD7779 24-Bit Simultaneous Sampling Sigma-Delta ADC
- AN-1392: How to Calculate Offset Errors and Input Impedance in ADC Converters with Chopped Amplifiers
- AN-1393: Translating System Level Protection and Measurement Requirements to ADC Specifications
- AN-1405: Diagnostic Features on the AD7770 and AD7779

Data Sheet

- AD7771: 8-Channel, 24-Bit Simultaneous Sampling ADCs Data Sheet

User Guides

- UG-884: Evaluating the AD7770, AD7771, and AD7779 8-Channel, 24-Bit, Simultaneous Sampling, Sigma-Delta ADCs with Power Scaling

SOFTWARE AND SYSTEMS REQUIREMENTS

- AD7770/AD7771/AD7779 - No-OS Driver

TOOLS AND SIMULATIONS

- AD7770/AD7771/AD7779 Filter Model
- AD7771 CRC Calculator
- AD7770/AD7771/AD7779 IBIS Model

REFERENCE MATERIALS

Press

- Analog Devices Improves Monitoring and Protection of Smart Grid Transmission and Distribution Equipment

DESIGN RESOURCES

- AD7771 Material Declaration
- PCN-PDN Information
- Quality And Reliability
- Symbols and Footprints

DISCUSSIONS

View all AD7771 EngineerZone Discussions.

SAMPLE AND BUY

Visit the product page to see pricing options.

TECHNICAL SUPPORT

Submit a technical question or find your regional support number.

DOCUMENT FEEDBACK

Submit feedback for this data sheet.

TABLE OF CONTENTS

| | | | |
|---|----|---|----|
| Features | 1 | Σ - Δ Output Data..... | 53 |
| Applications..... | 1 | ADC Conversion Output—Header and Data | 53 |
| General Description | 1 | Sample Rate Converter (SRC) (SPI Control Mode) | 54 |
| Revision History | 3 | Data Output Interface..... | 56 |
| Functional Block Diagram | 4 | Calculating the CRC Checksum | 60 |
| Specifications..... | 5 | Register Summary | 61 |
| DOUTx Timing Characteristics..... | 9 | Register Details | 65 |
| SPI Timing Characteristics | 10 | Channel 0 Configuration Register | 65 |
| Synchronization Pins and Reset Timing Characteristics | 11 | Channel 1 Configuration Register | 65 |
| SAR ADC Timing Characteristics | 12 | Channel 2 Configuration Register | 66 |
| GPIO SRC Update Timing Characteristics..... | 12 | Channel 3 Configuration Register | 66 |
| Absolute Maximum Ratings..... | 13 | Channel 4 Configuration Register | 67 |
| Thermal Resistance | 13 | Channel 5 Configuration Register | 67 |
| ESD Caution..... | 13 | Channel 6 Configuration Register | 68 |
| Pin Configuration and Function Descriptions..... | 14 | Channel 7 Configuration Register | 68 |
| Typical Performance Characteristics | 17 | Disable Clocks to ADC Channel Register | 69 |
| Terminology | 32 | Channel 0 Sync Offset Register | 69 |
| Theory of Operation | 34 | Channel 1 Sync Offset Register | 69 |
| Analog Inputs..... | 34 | Channel 2 Sync Offset Register | 69 |
| Transfer Function | 35 | Channel 3 Sync Offset Register | 70 |
| Core Signal Chain..... | 36 | Channel 4 Sync Offset Register | 70 |
| Capacitive PGA..... | 36 | Channel 5 Sync Offset Register | 70 |
| Internal Reference and Reference Buffers..... | 36 | Channel 6 Sync Offset Register | 70 |
| Integrated LDOs | 37 | Channel 7 Sync Offset Register | 70 |
| Clocking and Sampling..... | 37 | General User Configuration 1 Register | 71 |
| Digital Reset and Synchronization Pins | 37 | General User Configuration 2 Register | 72 |
| Digital Filtering..... | 38 | General User Configuration 3 Register..... | 73 |
| Shutdown Mode..... | 38 | Data Output Format Register | 73 |
| Controlling the AD7771..... | 39 | Main ADC Meter and Reference Mux Control Register | 74 |
| Pin Control Mode..... | 39 | Global Diagnostics Mux Register..... | 75 |
| SPI Control..... | 42 | GPIO Configuration Register..... | 75 |
| Digital SPI..... | 44 | GPIO Data Register..... | 76 |
| RMS Noise and Resolution..... | 47 | Buffer Configuration 1 Register | 76 |
| High Resolution Mode..... | 47 | Buffer Configuration 2 Register | 76 |
| Low Power Mode..... | 48 | Channel 0 Offset Upper Byte Register..... | 77 |
| Diagnostics and Monitoring | 49 | Channel 0 Offset Middle Byte Register | 77 |
| Self Diagnostics Error | 49 | Channel 0 Offset Lower Byte Register..... | 77 |
| Monitoring Using the AD7771 SAR ADC (SPI Control Mode)..... | 50 | Channel 0 Gain Upper Byte Register..... | 77 |
| Σ - Δ ADC Diagnostics (SPI Control Mode)..... | 52 | Channel 0 Gain Middle Byte Register | 77 |
| | | Channel 0 Gain Lower Byte Register..... | 78 |

| | | | |
|--|----|---|----|
| Channel 1 Offset Upper Byte Register | 78 | Channel 6 Gain Lower Byte Register | 85 |
| Channel 1 Offset Middle Byte Register..... | 78 | Channel 7 Offset Upper Byte Register | 85 |
| Channel 1 Offset Lower Byte Register | 78 | Channel 7 Offset Middle Byte Register..... | 85 |
| Channel 1 Gain Upper Byte Register..... | 78 | Channel 7 Offset Lower Byte Register | 85 |
| Channel 1 Gain Middle Byte Register..... | 79 | Channel 7 Gain Upper Byte Register | 86 |
| Channel 1 Gain Lower Byte Register..... | 79 | Channel 7 Gain Middle Byte Register..... | 86 |
| Channel 2 Offset Upper Byte Register | 79 | Channel 7 Gain Lower Byte Register | 86 |
| Channel 2 Offset Middle Byte Register..... | 79 | Channel 0 Status Register | 86 |
| Channel 2 Offset Lower Byte Register | 79 | Channel 1 Status Register | 87 |
| Channel 2 Gain Upper Byte Register..... | 80 | Channel 2 Status Register | 87 |
| Channel 2 Gain Middle Byte Register | 80 | Channel 3 Status Register | 88 |
| Channel 2 Gain Lower Byte Register..... | 80 | Channel 4 Status Register | 88 |
| Channel 3 Offset Upper Byte Register | 80 | Channel 5 Status Register | 89 |
| Channel 3 Offset Middle Byte Register..... | 80 | Channel 6 Status Register | 89 |
| Channel 3 Offset Lower Byte Register | 81 | Channel 7 Status Register | 90 |
| Channel 3 Gain Upper Byte Register..... | 81 | Channel 0/Channel 1 DSP Errors Register..... | 90 |
| Channel 3 Gain Middle Byte Register..... | 81 | Channel 2/Channel 3 DSP Errors Register..... | 91 |
| Channel 3 Gain Lower Byte Register..... | 81 | Channel 4/Channel 5 DSP Errors Register..... | 91 |
| Channel 4 Offset Upper Byte Register | 81 | Channel 6/Channel 7 DSP Errors Register..... | 92 |
| Channel 4 Offset Middle Byte Register..... | 82 | Channel 0 to Channel 7 Error Register Enable Register | 92 |
| Channel 4 Offset Lower Byte Register | 82 | General Errors Register 1..... | 93 |
| Channel 4 Gain Upper Byte Register..... | 82 | General Errors Register 1 Enable..... | 93 |
| Channel 4 Gain Middle Byte Register | 82 | General Errors Register 2..... | 94 |
| Channel 4 Gain Lower Byte Register..... | 82 | General Errors Register 2 Enable..... | 94 |
| Channel 5 Offset Upper Byte Register | 83 | Error Status Register 1..... | 95 |
| Channel 5 Offset Middle Byte Register..... | 83 | Error Status Register 2..... | 95 |
| Channel 5 Offset Lower Byte Register | 83 | Error Status Register 3..... | 96 |
| Channel 5 Gain Upper Byte Register..... | 83 | Decimation Rate (N) MSB Register | 96 |
| Channel 5 Gain Middle Byte Register | 83 | Decimation Rate (N) LSB Register | 96 |
| Channel 5 Gain Lower Byte Register..... | 84 | Decimation Rate (IF) MSB Register..... | 96 |
| Channel 6 Offset Upper Byte Register | 84 | Decimation Rate (IF) LSB Register | 97 |
| Channel 6 Offset Middle Byte Register..... | 84 | SRC Load Source and Load Update Register | 97 |
| Channel 6 Offset Lower Byte Register | 84 | Outline Dimensions..... | 98 |
| Channel 6 Gain Upper Byte Register..... | 84 | Ordering Guide | 98 |
| Channel 6 Gain Middle Byte Register..... | 85 | | |

REVISION HISTORY

6/2017—Revision 0: Initial Version

FUNCTIONAL BLOCK DIAGRAM

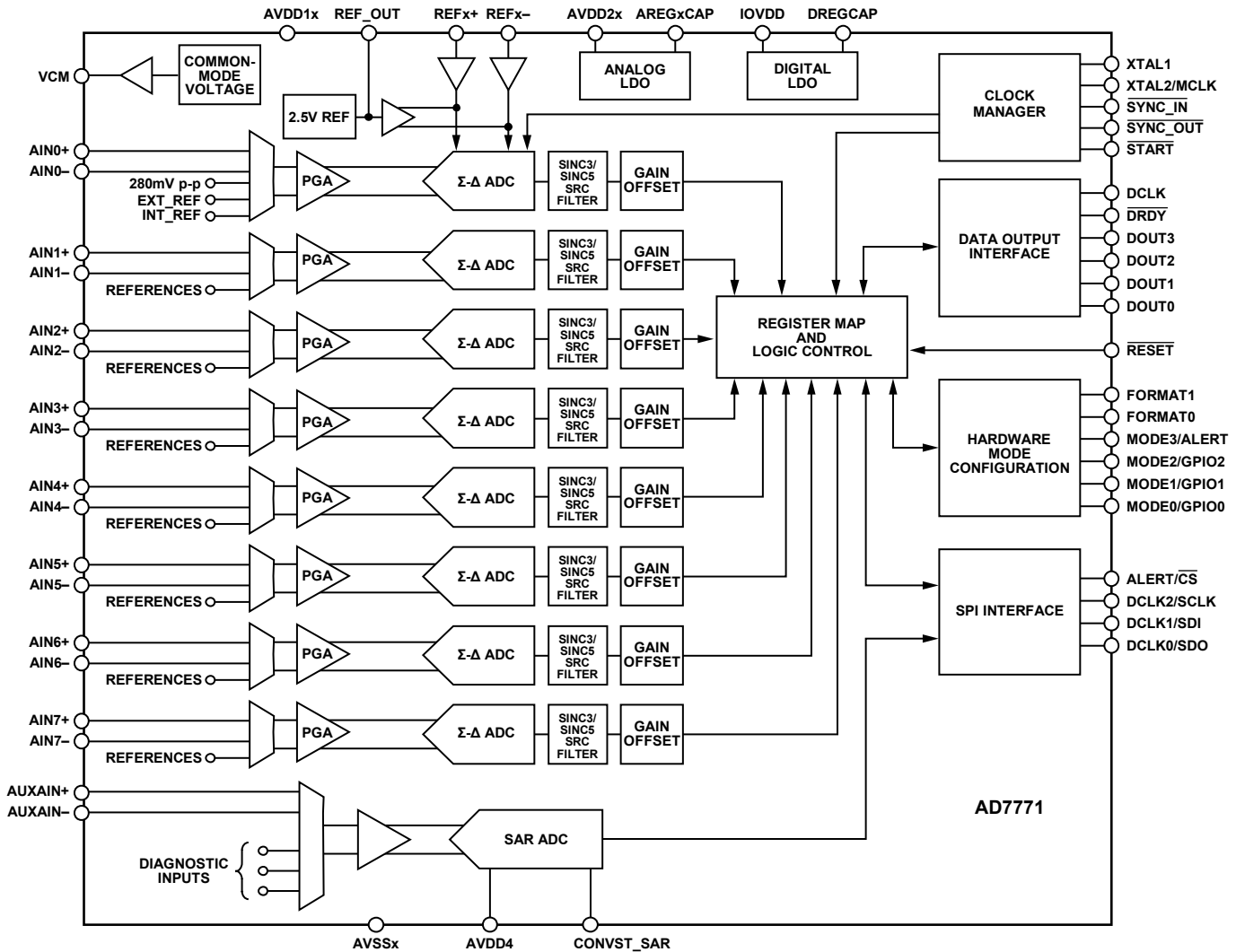

Figure 1.

13802-001

SPECIFICATIONS

AVDD1x = 1.65 V, AVSSx¹ = -1.65 V (dual supply operation), AVDD1x = 3.3 V, AVSSx = analog ground (AGND) (single-supply operation), AVDD2x - AVSSx = 2.2 V to 3.6 V; IOVDD = 1.8 V to 3.6 V; DGND = 0 V, REFx+/REFx- = 2.5 V AVSSx (internal/external), master clock (MCLK) = 8192 kHz for high resolution mode and 4096 kHz for low power mode, ODR = 128 kSPS for high resolution mode and 32 kSPS for low power mode; all specifications at T_{MIN} to T_{MAX}, unless otherwise noted.

Table 1.

| Parameter | Test Conditions/Comments | Min | Typ | Max | Unit |
|---|---|--------------|---|--|--------|
| ANALOG INPUTS | | | | | |
| Differential Input Voltage Range | V _{REF} = (REFx+ - REFx-) | | | ±V _{REF} /PGA _{GAIN} | V |
| Single-Ended Input Voltage Range | | | | 0 to V _{REF} /PGA _{GAIN} | V |
| AINx± Common-Mode Input Range | | AVSSx + 0.10 | (AVDD1x + AVSSx)/2 | AVDD1x - 0.10 | V |
| Absolute AINx± Voltage Limits | | AVSSx + 0.10 | | AVDD1x - 0.10 | V |
| DC Input Current | | | | | |
| Differential | High resolution mode | | ±4 | | nA |
| | Low power mode | | ±1 | | nA |
| Single-Ended | High resolution mode | | ±8 | | nA |
| | Low power mode | | ±2 | | nA |
| Input Current Drift | | | 50 | | pA/°C |
| AC Input Capacitance | | | 8 | | pF |
| PROGRAMMABLE GAIN AMPLIFIER (PGA) | | | | | |
| Gain Settings (PGA _{GAIN}) | | | 1, 2, 4, or 8 | | |
| Bandwidth | | | | | |
| Small Signal | High resolution mode | | | 2 | MHz |
| | Low power mode | | | 512 | kHz |
| Large Signal | High resolution mode | | See Figure 39, Figure 40, and Figure 44 | | |
| | Low power mode | | See Figure 42, Figure 43, and Figure 47 | | |
| REFERENCE | | | | | |
| Internal | | | | | |
| Initial Accuracy | REF_OUT, T _A = 25°C | 2.495 | 2.5 | 2.505 | V |
| Temperature Coefficient | | | ±10 | ±38 | ppm/°C |
| Reference Load Current, I _L | | -10 | | +10 | mA |
| DC Power Supply Rejection | Line regulation | | 95 | | dB |
| Load Regulation, ΔV _{OUT} /ΔI _L | | | 100 | | μV/mA |
| Voltage Noise, e _{N,p-p} | 0.1 Hz to 10 Hz | | 6.8 | | μV rms |
| Voltage Noise Density, e _N | 1 kHz, 2.5 V reference | | 273.5 | | nV/√Hz |
| Turn On Settling Time | 100 nF | | 1.5 | | ms |
| External | | | | | |
| Input Voltage | V _{REF} = (REFx+ - REFx-) | 1 | 2.5 | AVDD1x | V |
| Buffer Headroom | | AVSSx + 0.1 | | AVDD1x - 0.1 | V |
| REFx- Input Voltage | | | AVSSx | AVDD1x - REFx+ | V |
| Average REFx± Input Current | Current per channel | | | | |
| | Reference buffer disabled, high resolution mode | | 18 | | μA/V |
| | Reference buffer precharge mode (pre-Q), high resolution mode | | 600 | | nA/V |
| | Reference buffer disabled, low power mode | | 4.5 | | μA/V |
| | Reference buffer pre-Q, low power mode | | 100 | | nA/V |
| | Reference buffer enabled, high resolution mode | | 12 | | nA/V |
| | Reference buffer enabled, low power mode | | 5 | | nA/V |

| Parameter | Test Conditions/Comments | Min | Typ | Max | Unit |
|--|--|--------------|--|----------------|--------------------------|
| TEMPERATURE RANGE | | | | | |
| Specified Performance | T_{MIN} to T_{MAX} | -40 | | +105 | °C |
| Functional ² | T_{MIN} to T_{MAX} | -40 | | +125 | °C |
| TEMPERATURE SENSOR | | | | | |
| Accuracy | | | ±2 | | °C |
| DIGITAL FILTER RESPONSE | | | | | |
| Group Delay | | | See the SRC Group Delay section | | |
| Settling Time | | | See the Settling Time section | | |
| Pass Band | -0.1 dB -3 dB | | See the SRC Bandwidth section See the SRC Bandwidth section | | |
| Decimation Rate | | | | | |
| Sinc3 | | 16 | | 4095.99 | |
| Sinc5 | | 16 | | 2048 | |
| CLOCK SOURCE | | | | | |
| Frequency | High resolution mode Low power mode | 0.655 1.3 | | 8.192 4.096 | MHz MHz |
| Duty Cycle | | 45:55 | 50:50 | 55:45 | % |
| Σ-Δ ADC | | | | | |
| Speed and Performance | | | | | |
| Resolution | | 24 | | | Bits |
| ODR | High resolution mode Low power mode | | | 128 32 | kSPS kSPS |
| No Missing Codes | Sinc3, up to 24 kSPS Sinc5 | 24 24 | | | Bits Bits |
| AC Accuracy | | | | | |
| Dynamic Range | Shorted inputs, $PGA_{GAIN} = 1$ | | | | |
| 128 kSPS | High resolution mode (sinc5) | | 95 | | dB |
| 32 kSPS | High resolution mode (sinc5) | | 107 | | dB |
| 16 kSPS | High resolution mode (sinc3) | | 105.9 | | dB |
| 4 kSPS | High resolution mode (sinc3) | | 116 | | dB |
| 32 kSPS | Low power mode (sinc5) | | 94.5 | | dB |
| 8 kSPS | Low power mode (sinc5) | | 106.5 | | dB |
| 8 kSPS | Low power mode (sinc3) | | 95.8 | | dB |
| 2 kSPS | Low power mode (sinc3) | | 111.8 | | dB |
| Total Harmonic Distortion (THD) | -0.5 dBFS, high resolution mode -0.5 dBFS, low power mode | | -109 -105 | | dB dB |
| Signal-to-Noise-and-Distortion Ratio (SINAD) | $f_{IN} = 60$ Hz | | 106 | | dB |
| Spurious-Free Dynamic Range (SFDR) | High resolution mode, 16 kSPS, $PGA_{GAIN} = 1$ | | 132 | | dB |
| Intermodulation Distortion (IMD) | $f_A = 50$ Hz, $f_B = 51$ Hz, high resolution mode $f_A = 50$ Hz, $f_B = 51$ Hz, low power mode | | -125 -105 | | dB dB |
| DC Power Supply Rejection | $AVDD1X = 3.3$ V | | -90 | | dB |
| DC Common-Mode Rejection Ratio | | 80 | | | dB |
| Crosstalk | | | -120 | | dB |
| DC ACCURACY | | | | | |
| Integral Nonlinearity (INL) | Endpoint method | | | | |
| High Resolution | $PGA_{GAIN} = 1$ Other PGA gains | | ±8 ±4 | ±15 ±15 | ppm of FSR ppm of FSR |

| Parameter | Test Conditions/Comments | Min | Typ | Max | Unit |
|---|---|-------------|--------------------|-------------|---------------|
| Low Power | PGA _{GAIN} = 1 | | ±9 | ±17 | ppm of FSR |
| | Other PGA gains | | ±6 | ±15 | ppm of FSR |
| Offset Error | | | ±15 | ±90 | μV |
| Offset Error Drift | Over time | | 0.25 | | μV/°C |
| | | | -2 | | μV/1000 hours |
| Offset Matching | | | 25 | | μV |
| Gain Error | | | ±0.1 | | % FS |
| Gain Error Drift vs. Temperature | PGA _{GAIN} = 1 | | ±0.75 | | ppm/°C |
| Gain Matching | | | ±0.1 | | % |
| SAR ADC | | | | | |
| Speed and Performance | | | | | |
| Resolution | | | 12 | | Bits |
| Analog Input Range | | AVSS4 + 0.1 | | AVDD4 - 0.1 | V |
| Analog Input Common-Mode Range | | AVSS4 + 0.1 | (AVDD4 + AVSS4)/2 | AVDD4 - 0.1 | V |
| Analog Input Current | | | ±100 | | nA |
| Throughput | | | | 256 | kSPS |
| DC Accuracy | Differential mode | | | | |
| INL | | | ±1.5 | | LSB |
| Differential Nonlinearity (DNL) | No missing codes (12-bit) | -0.99 | | 1 | LSB |
| Offset | | | ±1 | | LSB |
| Gain | | | 12 | | LSB |
| AC Performance | | | | | |
| Signal-to-Noise Ratio (SNR) | 1 kHz | | 66 | | dB |
| THD | 1 kHz | | -81 | | dB |
| VCM PIN | | | | | |
| Output (V _{CM}) | | | (AVDD1x + AVSSx)/2 | | V |
| Load Current, I _L | | | 1 | | mA |
| Load Regulation, ΔV _{OUT} /ΔI _L | | | 12 | | mV/mA |
| Short-Circuit Current | | | 5 | | mA |
| LOGIC INPUTS | | | | | |
| Input Voltage | | | | | |
| High, V _{IH} | | 0.7 × IOVDD | | | V |
| Low, V _{IL} | | | | 0.4 | V |
| Hysteresis | | | 0.1 | | V |
| Input Currents | | -10 | | +10 | μA |
| LOGIC OUTPUTS³ | | | | | |
| Output Voltage | | | | | |
| High, V _{OH} | IOVDD ≥ 3 V, I _{SOURCE} = 1 mA | 0.8 × IOVDD | | | V |
| | 2.3 V ≤ IOVDD < 3 V, I _{SOURCE} = 500 μA | 0.8 × IOVDD | | | V |
| | IOVDD < 2.3 V, I _{SOURCE} = 200 μA | 0.8 × IOVDD | | | V |
| Low, V _{OL} | IOVDD ≥ 3 V, I _{SINK} = 2 mA | | | 0.4 | V |
| | 2.3 V ≤ IOVDD < 3 V, I _{SINK} = 1 mA | | | 0.4 | V |
| | IOVDD < 2.3 V, I _{SINK} = 100 μA | | | 0.4 | V |
| Leakage Current | Floating state | -10 | | +10 | μA |
| Output Capacitance | Floating state | | 10 | | pF |
| Σ-Δ ADC Data Output Coding | | | Twos complement | | |
| SAR ADC Data Output Coding | | | Binary | | |

| Parameter | Test Conditions/Comments | Min | Typ | Max | Unit |
|--------------------------------|--|------|------|-------|---------|
| POWER SUPPLIES | All Σ - Δ channels enabled | | | | |
| AVDD1x – AVSSx | | 3.0 | | 3.6 | V |
| I_{AVDD1x} ^{4,5} | Reference buffer pre-Q, VCM enabled, internal reference enabled | | | | |
| | High resolution mode | | 18.3 | 23.7 | mA |
| | Low power mode | | 5 | 6.4 | mA |
| | Reference buffer enabled, VCM enabled, internal reference enabled | | | | |
| | High resolution mode | | 20.5 | 26.7 | mA |
| | Low power mode | | 5.5 | 7.1 | mA |
| | Reference buffer disabled, VCM disabled, internal reference disabled | | | | |
| | High resolution mode | | 14.3 | 18.8 | mA |
| | Low power mode | | 3.9 | 5.1 | mA |
| AVDD2x – AVSSx | | 2.2 | | 3.6 | V |
| I_{AVDD2x} | High resolution mode | | 10.2 | 10.65 | mA |
| | Low power mode | | 3.8 | 4 | mA |
| AVDD4 – AVSSx | | 3 | | 3.6 | V |
| I_{AVDD4} | SAR enabled | | 1.7 | 2 | mA |
| | SAR disabled | | 1 | 10 | μ A |
| AVSSx – DGND | | –1.8 | | 0 | V |
| IOVDD – DGND | | 1.8 | | 3.6 | V |
| I_{IOVDD} | High resolution mode (sinc5) | | 14.3 | 17 | mA |
| | Low power mode (sinc5) | | 4.6 | 5.5 | mA |
| | High resolution mode (sinc3) | | 12.2 | 14.2 | mA |
| | Low power mode (sinc3) | | 2.2 | 4.9 | mA |
| Power Dissipation ⁶ | Internal buffers bypassed, internal reference disabled, internal oscillator disabled, SAR disabled | | | | |
| High Resolution Mode | 128 kSPS | | 133 | 153 | mW |
| Low Power Mode | 32 kSPS | | 42 | 48.5 | mW |
| Power-Down | All ADCs disabled | | 530 | | μ W |

¹ AVSSx refers to the following pins: AVSS1A, AVSS1B, AVSS2A, AVSS2B, AVDD3, and AVSS4. This term is used throughout the data sheet.

² At temperatures higher than 105°C, the device can be operated normally, though slight degradation on the maximum/minimum specifications is expected because these specifications are only guaranteed up to 105°C. See the Typical Performance Characteristics section for plots showing the typical performance of the device at high temperatures.

³ The SDO pin and the DOUTx pin are configured in the default mode of strength.

⁴ AVDD1x = 3.3 V, AVSSx = GND = ground, IOVDD = 1.8 V, CMOS clock.

⁵ Disabling either the VCM pin or the internal reference results in a 40 μ A typical current consumption reduction.

⁶ Power dissipation is calculated using the maximum supply voltage, 3.6 V.

DOUTx TIMING CHARACTERISTICS

AVDD1x = 1.65 V, AVSSx¹ = -1.65 V (dual supply operation), AVDD1x = 3.3 V, AVSSx = AGND (single-supply operation), AVDD2 – AVSSx = 2.2 V to 3.6 V; IOVDD = 1.8 V to 3.6 V; DGND = 0 V, REFx+/REFx- = 2.5 V internal/external, MCLK = 8192 kHz; all specifications at T_{MIN} to T_{MAX}, unless otherwise noted.

Table 2.

| Parameter | Description ² | Test Conditions/Comments | Min | Typ | Max | Unit |
|-----------------|---|--------------------------|-------|-----|-------|------|
| t ₁ | MCLK frequency | 50:50 | 0.655 | | 8.192 | MHz |
| t ₂ | MCLK low time | | 60 | | | ns |
| t ₃ | MCLK high time | | 60 | | | ns |
| t ₄ | DCLK high time | MCLK/2 | 121 | | | ns |
| t ₅ | DCLK low time | MCLK/2 | 121 | | | ns |
| t ₆ | MCLK falling edge to DCLK rising edge | | | | 45 | ns |
| t ₇ | MCLK falling edge to DCLK falling edge | | | | 45 | ns |
| t ₈ | DCLK rising edge to $\overline{\text{DRDY}}$ rising edge | | 2 | | | ns |
| t ₉ | DCLK rising edge to $\overline{\text{DRDY}}$ falling edge | | 1 | | | ns |
| t ₁₀ | DOUTx setup time | | 20 | | | ns |
| t ₁₁ | DOUTx hold time | | 20 | | | ns |

¹ AVSSx refers to the following pins: AVSS1A, AVSS1B, AVSS2A, AVSS2B, AVSS3, and AVSS4. This term is used throughout the data sheet.

² All input signals are specified with t_r = t_f = 1 ns/V (10% to 90% of IOVDD) and timed from a voltage level of (V_{IL} + V_{IH})/2.

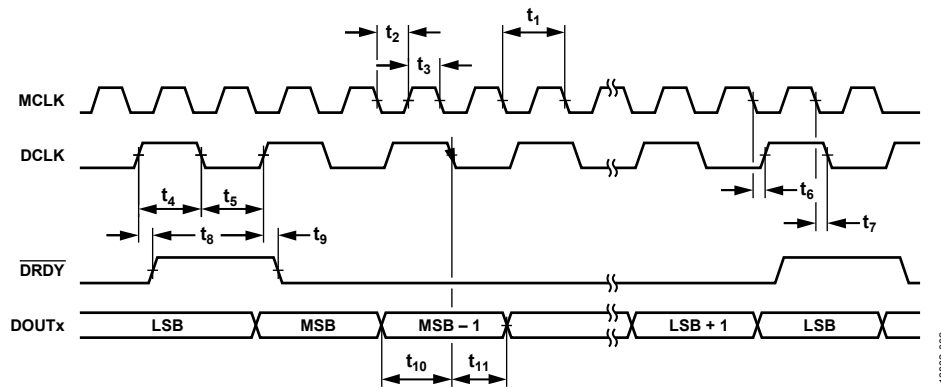

Figure 2. Data Interface Timing Diagram

13802-002

SPI TIMING CHARACTERISTICS

AVDD1x = 1.65 V, AVSSx¹ = -1.65 V (dual supply operation), AVDD1x = 3.3 V, AVSSx = AGND, AVDD2 – AVSSx = 2.2 V to 3.6 V; IOVDD = 1.8 V to 3.6 V; DGND = 0 V, REFx+/REFx- = 2.5 V (internal/external), MCLK = 8192 kHz; all specifications at T_{MIN} to T_{MAX}, unless otherwise noted.

Table 3.

| Parameter | Description ² | Test Conditions/Comments | Min | Typ | Max | Unit |
|------------------|--|--------------------------|-----|-----|-----|------|
| t ₁₂ | SCLK period | 50:50 | | | 30 | MHz |
| t ₁₃ | SCLK low time | | 7 | | | ns |
| t ₁₄ | SCLK high time | | 7 | | | ns |
| t ₁₅ | SCLK rising edge to $\overline{\text{CS}}$ falling edge | | 10 | | | ns |
| t ₁₆ | $\overline{\text{CS}}$ falling edge to SCLK rising edge | | 10 | | | ns |
| t ₁₇ | SCLK rising edge to $\overline{\text{CS}}$ rising edge | | 10 | | | ns |
| t ₁₈ | $\overline{\text{CS}}$ rising edge to SCLK rising edge | | 10 | | | ns |
| t ₁₉ | Minimum $\overline{\text{CS}}$ high time | | 10 | | | ns |
| t ₂₀ | SDI setup time | | 5 | | | ns |
| t ₂₁ | SDI hold time | | 5 | | | ns |
| t _{22A} | $\overline{\text{CS}}$ falling edge to SDO enable (SPI = Mode 0) | | 30 | | | ns |
| t _{22B} | SCLK falling edge to SDO enable (SPI = Mode 1) | | 49 | | | ns |
| t ₂₃ | SDO setup time | | 10 | | | ns |
| t ₂₄ | SDO hold time | | 10 | | | ns |
| t ₂₅ | $\overline{\text{CS}}$ rising edge to SDO disable | | 30 | | | ns |

¹ AVSSx refers to the following pins: AVSS1A, AVSS1B, AVSS2A, AVSS2B, AVSS3, and AVSS4. This term is used throughout the data sheet.

² All input signals are specified with t_{tr} = t_{tf} = 1 ns/V (10% to 90% of IOVDD) and timed from a voltage level of (V_{IL} + V_{IH})/2.

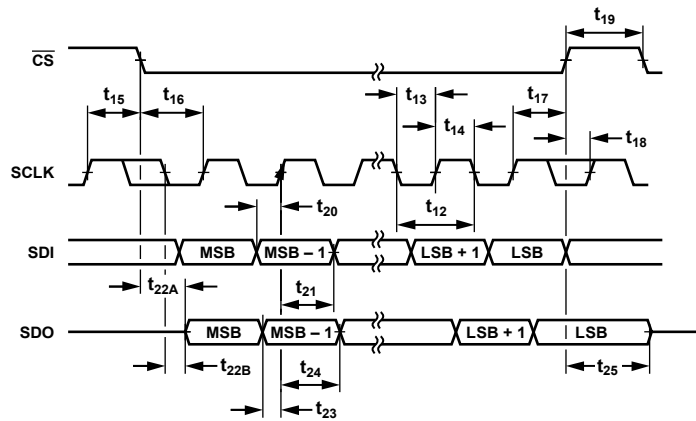

Figure 3. SPI Control Interface Timing Diagram

13802-003

SYNCHRONIZATION PINS AND RESET TIMING CHARACTERISTICS

AVDD1x = 1.65 V, AVSSx¹ = -1.65 V (dual supply operation), AVDD1x = 3.3 V, AVSSx = AGND, AVDD2 – AVSSx = 2.2 V to 3.6 V; IOVDD = 1.8 V to 3.6 V; DGND = 0 V, REFx+/REFx- = 2.5 V (internal/external), MCLK = 8192 kHz; all specifications at T_{MIN} to T_{MAX}, unless otherwise noted.

Table 4.

| Parameter | Description ² | Test Conditions/Comments | Min | Typ | Max | Unit |
|---------------------------|--|--|----------|-----|-----|------|
| t ₂₆ | START setup time | | 10 | | | ns |
| t ₂₇ | START hold time | | MCLK | | | ns |
| t ₂₈ | MCLK falling edge to SYNC_OUT falling edge | | MCLK | | | ns |
| t ₂₉ | SYNC_IN setup time | | 10 | | | ns |
| t ₃₀ | SYNC_IN hold time | | MCLK | | | ns |
| t _{INIT_SYNC_IN} | SYNC_IN rising edge to first DRDY | 16 kSPS, high resolution mode | 145 | | | μs |
| t _{INIT_RESET} | RESET rising edge to first DRDY | 16 kSPS, high resolution mode | 225 | | | μs |
| t ₃₁ | RESET hold time | | 2 × MCLK | | | ns |
| t _{POWER_UP} | Start time | t _{POWER_UP} is not shown in Figure 4 | | 2 | | ms |

¹ AVSSx refers to the following pins: AVSS1A, AVSS1B, AVSS2A, AVSS2B, AVSS3, and AVSS4. This term is used throughout the data sheet.

² All input signals are specified with t_r = t_f = 1 ns/V (10% to 90% of IOVDD) and timed from a voltage level of (V_{IL} + V_{IH})/2.

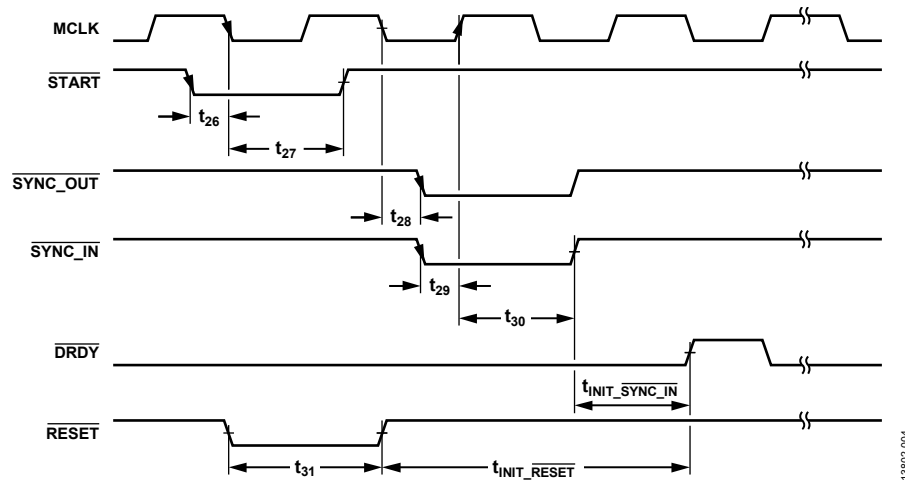

Figure 4. Synchronization Pins and Reset Control Interface Timing Diagram

13802-004

SAR ADC TIMING CHARACTERISTICS

AVDD1x = 1.65 V, AVSSx¹ = -1.65 V (dual supply operation), AVDD1x = 3.3 V, AVSSx = AGND, AVDD2 – AVSSx = 2.2 V to 3.6 V; IOVDD = 1.8 V to 3.6 V; DGND = 0 V, REFx+/REFx- = 2.5 V (internal/external), MCLK = 8192 kHz; all specifications at T_{MIN} to T_{MAX}, unless otherwise noted.

Table 5.

| Parameter | Description ² | Min | Typ | Max | Unit |
|-----------------|-------------------------------|-----|-----|-----|------|
| t ₃₂ | Conversion time | 1 | | 3.4 | μs |
| t ₃₃ | Acquisition time ³ | 500 | | | ns |
| t ₃₄ | Delay time | 50 | | | ns |
| t ₃₅ | Throughput data rate | | | 256 | kSPS |

¹ AVSSx refers to the following pins: AVSS1A, AVSS1B, AVSS2A, AVSS2B, AVSS3 and AVSS4. This term is used throughout the data sheet.

² All input signals are specified with t_r = t_f = 1 ns/V (10% to 90% of IOVDD) and timed from a voltage level of (V_{IL} + V_{IH})/2.

³ Direct mode enabled. If deglitch mode is enabled, add 1.5/MCLK as described in Table 29.



Figure 5. SAR ADC Timing Diagram

GPIO SRC UPDATE TIMING CHARACTERISTICS

AVDD1x = 1.65 V, AVSSx¹ = -1.65 V (dual supply operation), AVDD1x = 3.3 V, AVSSx = AGND, AVDD2 – AVSSx = 2.2 V to 3.6 V; IOVDD = 1.8 V to 3.6 V; DGND = 0 V, REFx+/REFx- = 2.5 V (internal/external), MCLK = 8192 kHz; all specifications T_{MIN} to T_{MAX}, unless otherwise noted.

Table 6.

| Parameter | Description ² | Min | Typ | Max | Unit |
|-----------------|--|----------|-----|-----|------|
| t ₃₆ | GPIO2 setup time | 10 | | | ns |
| t ₃₇ | GPIO2 hold time—high resolution mode | MCLK | | | ns |
| | GPIO2 hold time—low power mode | 2 × MCLK | | | ns |
| t ₃₈ | MCLK rising edge to GPIO1 rising edge time | 20 | | | ns |
| t ₃₉ | GPIO0 setup time | 5 | | | ns |
| t ₄₀ | GPIO0 hold time | MCLK | | | ns |

¹ AVSSx refers to the following pins: AVSS1A, AVSS1B, AVSS2A, AVSS2B, AVSS3 and AVSS4. This term is used throughout the data sheet.

² All input signals are specified with t_r = t_f = 1 ns/V (10% to 90% of IOVDD) and timed from a voltage level of (V_{IL} + V_{IH})/2.

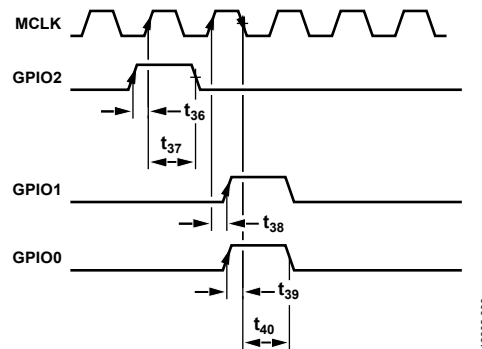

Figure 6. GPIOs for SRC Update Timing Diagram

ABSOLUTE MAXIMUM RATINGS

Table 7.

| Parameter | Rating |
|--|---|
| Any Supply Pin to AVSSx | −0.3 V to +3.96 V |
| AVSSx to DGND | −1.98 V to +0.3 V |
| AREGxCAP to AVSSx | −0.3 V to +1.98 V |
| DREGCAP to DGND | −0.3 V to +1.98 V |
| IOVDD to DGND | −0.3 V to +3.96 V |
| IOVDD to AVSSx | −0.3 V to +5.94 V |
| AVDD4 to AVSSx | −0.3 V to +3.96 V |
| Analog Input Voltage | AVSSx − 0.3 V to AVDD1x + 0.3 V or 3.96 V (whichever is less) |
| REFx± Input Voltage | AVSSx − 0.3 V to AVDD1x + 0.3 V or 3.96 V (whichever is less) |
| AUXAIN± | AVSSx − 0.3 V to AVDD4 + 0.1 V or 3.96 V (whichever is less) |
| Digital Input Voltage to DGND | DGND − 0.3 V to IOVDD + 0.3 V or 3.96 V (whichever is less) |
| Digital Output Voltage to DGND | DGND − 0.3 V to IOVDD + 0.3 V or 3.96 V (whichever is less) |
| XTAL1 to DGND | DGND − 0.3 V to DREGCAP + 0.3 V or 1.98 V (whichever is less) |
| AINx±, AUXAIN±, and Digital Input Current | ±10 mA |
| Operating Temperature Range | −40°C to +125°C |
| Junction Temperature, T _J Maximum | 150°C |
| Storage Temperature Range | −65°C to +150°C |
| Reflow Soldering | 260°C |
| ESD | 2 kV |
| Field Induced Charged Device Model (FICDM) | 500 V |

Stresses at or above those listed under Absolute Maximum Ratings may cause permanent damage to the product. This is a stress rating only; functional operation of the product at these or any other conditions above those indicated in the operational section of this specification is not implied. Operation beyond the maximum operating conditions for extended periods may affect product reliability.

THERMAL RESISTANCE

Thermal performance is directly linked to printed circuit board (PCB) design and operating environment. Close attention to PCB thermal design is required.

Table 8. Thermal Resistance

| Package Type | θ_{JA} | θ_{JB} | Ψ_{JT} | Ψ_{JB} | Unit |
|-----------------------|---------------|------------------|-------------|-------------|------|
| CP-64-15 ¹ | | | | | |
| No Thermal Vias | 30.43 | N/A ² | 0.13 | 6.59 | °C/W |
| 49 Thermal Vias | 22.62 | 3.17 | 0.09 | 3.19 | °C/W |

¹ Thermal impedance simulated values are based on a JEDEC 2S2P thermal test board. See JEDEC JESD51.

² N/A means not applicable.

ESD CAUTION



ESD (electrostatic discharge) sensitive device. Charged devices and circuit boards can discharge without detection. Although this product features patented or proprietary protection circuitry, damage may occur on devices subjected to high energy ESD. Therefore, proper ESD precautions should be taken to avoid performance degradation or loss of functionality.

PIN CONFIGURATION AND FUNCTION DESCRIPTIONS

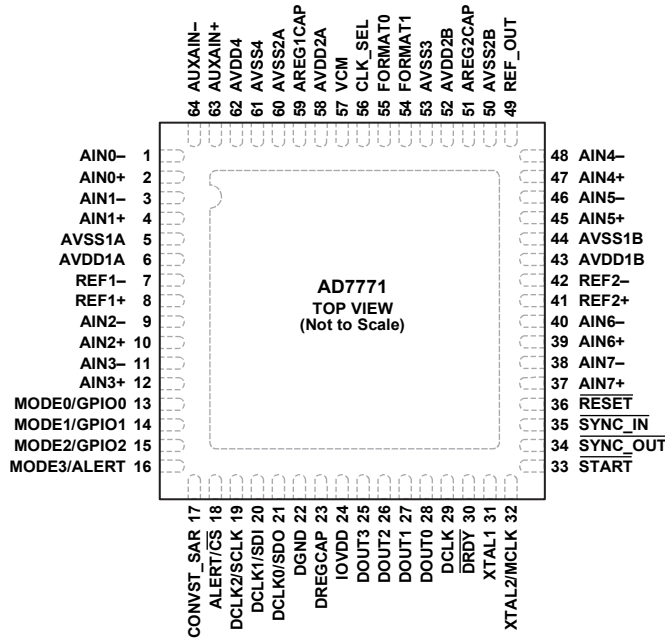

NOTES
 1. EXPOSED PAD. CONNECT THE EXPOSED PAD TO AVSSx.

Figure 7. Pin Configuration

Table 9. Pin Function Descriptions

| Pin No. | Mnemonic | Type | Direction | Description |
|---------|-------------|--------------|-----------|---|
| 1 | AIN0- | Analog input | Input | Analog Input Channel 0, Negative. |
| 2 | AIN0+ | Analog input | Input | Analog Input Channel 0, Positive. |
| 3 | AIN1- | Analog input | Input | Analog Input Channel 1, Negative. |
| 4 | AIN1+ | Analog input | Input | Analog Input Channel 1, Positive. |
| 5 | AVSS1A | Supply | Supply | Negative Front-End Analog Supply for Channel 0 to Channel 3, Typical at -1.65 V (Dual Supply) and AGND (Single Supply). Connect all the AVSSx pins to the same potential. |
| 6 | AVDD1A | Supply | Supply | Positive Front-End Analog Supply for Channel 0 to Channel 3, Typical at AVSSx + 3.3 V. Connect this pin to AVDD1B. |
| 7 | REF1- | Reference | Input | Negative Reference Input 1 for Channel 0 to Channel 3, Typical at AVSSx. Connect all the REFx- pins to the same potential. |
| 8 | REF1+ | Reference | Input | Positive Reference Input 1 for Channel 0 to Channel 3, Typical at REF1- + 2.5 V. |
| 9 | AIN2- | Analog input | Input | Analog Input Channel 2, Negative. |
| 10 | AIN2+ | Analog input | Input | Analog Input Channel 2, Positive. |
| 11 | AIN3- | Analog input | Input | Analog Input Channel 3, Negative. |
| 12 | AIN3+ | Analog input | Input | Analog Input Channel 3, Positive. |
| 13 | MODE0/GPIO0 | Digital I/O | I/O | Mode 0 Input in Pin Control Mode (MODE0). See Table 14 for more details. Configurable General-Purpose Input/Output 0 in SPI Control Mode (GPIO0). If not in use, connect this pin to DGND or IOVDD. |
| 14 | MODE1/GPIO1 | Digital I/O | I/O | Mode 1 Input in Pin Control Mode (MODE1). See Table 14 for more details. Configurable General-Purpose Input/Output 1 in SPI Control Mode (GPIO1). If not in use, connect this pin to DGND or IOVDD. |
| 15 | MODE2/GPIO2 | Digital I/O | I/O | Mode 2 Input in Pin Control Mode (MODE2). See Table 14 for more details. Configurable General-Purpose Input/Output 2 in SPI Control Mode (GPIO2). If not in use, connect this pin to DGND or IOVDD. |
| 16 | MODE3/ALERT | Digital I/O | I/O | Mode 3 Input in Pin Control Mode (MODE3). See Table 14 for more details. Alert Output in SPI Control Mode (ALERT). |

| Pin No. | Mnemonic | Type | Direction | Description |
|---------|-------------------------------|----------------|-----------|--|
| 17 | CONVST_SAR | Digital input | Input | Σ - Δ Output Interface Selection Pin in Pin Control Mode. See Table 13 for more details. This pin also functions as the start for the SAR conversion in SPI control mode. |
| 18 | ALERT/ $\overline{\text{CS}}$ | Digital input | Input | Alert Output in Pin Control Mode (ALERT). Chip Select in SPI Control Mode ($\overline{\text{CS}}$). |
| 19 | DCLK2/SCLK | Digital input | Input | Data Clock Frequency Selection Pin 2 in Pin Control Mode (DCLK2). See Table 15 for more details. SPI Clock in SPI Control Mode (SCLK). |
| 20 | DCLK1/SDI | Digital input | Input | Data Clock Frequency Selection Pin 1 in Pin Control Mode (DCLK1). See Table 15 for more details. SPI Data Input in SPI Control Mode (SDI). Connect this pin to DGND if the device is configured in pin control mode with the SPI as the data output interface. |
| 21 | DCLK0/SDO | Digital output | Output | Data Clock Frequency Selection Pin 0 in Pin Control Mode (DCLK0). See Table 15 for more details. SPI Data Output in SPI Control Mode (SDO). |
| 22 | DGND | Supply | Supply | Digital Ground. |
| 23 | DREGCAP | Supply | Output | Digital Low Dropout (LDO) Output. Decouple this pin to DGND with a 1 μF capacitor. |
| 24 | IOVDD | Supply | Supply | Digital Levels Input/Output and Digital LDO (DLDO) Supply from 1.8 V to 3.6 V. IOVDD must not be lower than DREGCAP. |
| 25 | DOUT3 | Digital output | I/O | Data Output Pin 3. If the device is configured in daisy-chain mode, this pin acts as an input pin. See the Daisy-Chain Mode section for more details. |
| 26 | DOUT2 | Digital output | I/O | Data Output Pin 2. If the device is configured in daisy-chain mode, this pin acts as an input pin. See the Daisy-Chain Mode section for more details. |
| 27 | DOUT1 | Digital output | Output | Data Output Pin 1. |
| 28 | DOUT0 | Digital output | Output | Data Output Pin 0. |
| 29 | DCLK | Digital output | Output | Data Output Clock. |
| 30 | $\overline{\text{DRDY}}$ | Digital output | Output | Data Output Ready Pin. |
| 31 | XTAL1 | Clock | Input | Crystal 1 Input Connection. If CMOS is used as a clock source, tie this pin to DGND. See Table 12 for more details. |
| 32 | XTAL2/MCLK | Clock | Input | Crystal 2 Input Connection (XTAL2). See Table 12 for more details. CMOS Clock (MCLK). See Table 12 for more details. |
| 33 | $\overline{\text{START}}$ | Digital input | Input | Synchronization Pulse. This pin internally synchronizes an external $\overline{\text{START}}$ asynchronous pulse with MCLK. The synchronize signal is shifted out by the SYNC_OUT pin. If not in use, tie this pin to DGND. See the Phase Adjustment section and the Digital Reset and Synchronization Pins section for more details. |
| 34 | $\overline{\text{SYNC_OUT}}$ | Digital output | Input | Synchronization Signal. This pin generates a synchronous pulse generated and driven by hardware (via the $\overline{\text{START}}$ pin) or by software (GENERAL_USER_CONFIG_2, Bit 0). If this pin is in use, it must be wired to the SYNC_IN pin. See the Phase Adjustment section and the Digital Reset and Synchronization Pins section for more details. |
| 35 | $\overline{\text{SYNC_IN}}$ | Digital input | Input | Reset for the Internal Digital Block and Synchronize for Multiple Devices. See the Digital Reset and Synchronization Pins section for more details. |
| 36 | $\overline{\text{RESET}}$ | Digital input | Input | Asynchronous Reset Pin. This pin resets all registers to their default value. It is recommended to generate a pulse on this pin after the device is powered up because a slow slew rate in the supplies may generate an incorrect initialization in the digital block. |
| 37 | AIN7+ | Analog input | Input | Analog Input Channel 7, Positive. |
| 38 | AIN7- | Analog input | Input | Analog Input Channel 7, Negative. |
| 39 | AIN6+ | Analog input | Input | Analog Input Channel 6, Positive. |
| 40 | AIN6- | Analog input | Input | Analog Input Channel 6, Negative. |
| 41 | REF2+ | Reference | Input | Positive Reference Input 2 for Channel 4 to Channel 7, Typical at REF2+ + 2.5 V. |
| 42 | REF2- | Reference | Input | Negative Reference Input 2 for Channel 4 to Channel 7, Typical at AVSSx. Connect all the REFx- pins to the same potential. |
| 43 | AVDD1B | Supply | Supply | Positive Front-End Analog Supply for Channel 4 to Channel 7. Connect this pin to AVDD1A. |

| Pin No. | Mnemonic | Type | Direction | Description |
|---------|----------|---------------|-----------|---|
| 44 | AVSS1B | Supply | Supply | Negative Front-End Analog Supply for Channel 4 to Channel 7, Typical at -1.65 V (Dual Supply) or AGND (Single Supply). Connect all the AVSSx pins to the same potential. |
| 45 | AIN5+ | Analog input | Input | Analog Input Channel 5, Positive. |
| 46 | AIN5- | Analog input | Input | Analog Input Channel 5, Negative. |
| 47 | AIN4+ | Analog input | Input | Analog Input Channel 4, Positive. |
| 48 | AIN4- | Analog input | Input | Analog Input Channel 4, Negative. |
| 49 | REF_OUT | Reference | Output | 2.5 V Reference Output. Connect a 100 nF capacitor on this pin if using the internal reference. |
| 50 | AVSS2B | Supply | Supply | Negative Analog Supply. Connect all the AVSSx pins together. |
| 51 | AREG2CAP | Supply | Output | Analog LDO Output 2. Decouple this pin to AVSS2B with a 1 μF capacitor. |
| 52 | AVDD2B | Supply | Supply | Positive Analog Supply. Connect this pin to AVDD2A. |
| 53 | AVSS3 | Supply | Supply | Negative Analog Ground. Connect all the AVSSx to the same potential. |
| 54 | FORMAT1 | Digital input | Input | Output Data Frame 1. See Table 13 for more details. |
| 55 | FORMAT0 | Digital input | Input | Output Data Frame 0. See Table 13 for more details. |
| 56 | CLK_SEL | Digital input | Input | Select Clock Source. See Table 12 for more details. |
| 57 | VCM | Analog output | Output | Common-Mode Voltage Output, Typical at $(\text{AVDD1x} + \text{AVSSx})/2$. |
| 58 | AVDD2A | Supply | Input | Analog Supply from 2.2V to 3.6V. AVSS2x must not be lower than AREGxCAP. Connect this pin to AVDD2B. |
| 59 | AREG1CAP | Supply | Output | Analog LDO Output 1. Decouple this pin to AVSSx with a 1 μF capacitor. |
| 60 | AVSS2A | Supply | Input | Negative Analog supply. Connect all the AVSSx pins to the same potential. |
| 61 | AVSS4 | Supply | Supply | Negative SAR Analog Supply and Reference. Connect all AVSSx pins to the same potential. |
| 62 | AVDD4 | Supply | Supply | Positive SAR Analog Supply and Reference Source. |
| 63 | AUXAIN+ | Analog input | Input | Positive SAR Analog Input Channel. |
| 64 | AUXAIN- | Analog input | Input | Negative SAR Analog Input Channel. |
| | EPAD | Supply | Input | Exposed Pad. Connect the exposed pad to AVSSx. |

TYPICAL PERFORMANCE CHARACTERISTICS

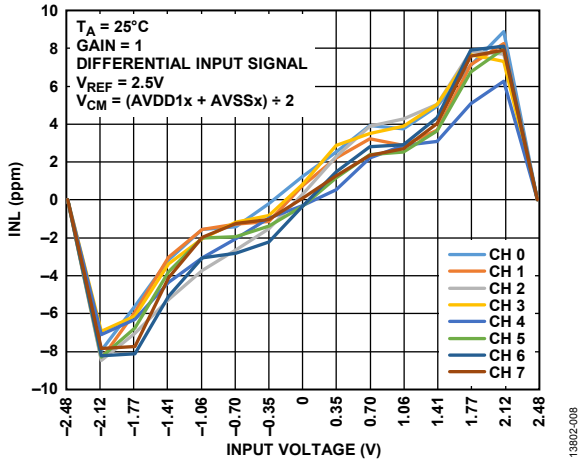

Figure 8. INL vs. Input Voltage and Channel at 64 kSPS, High Resolution Mode

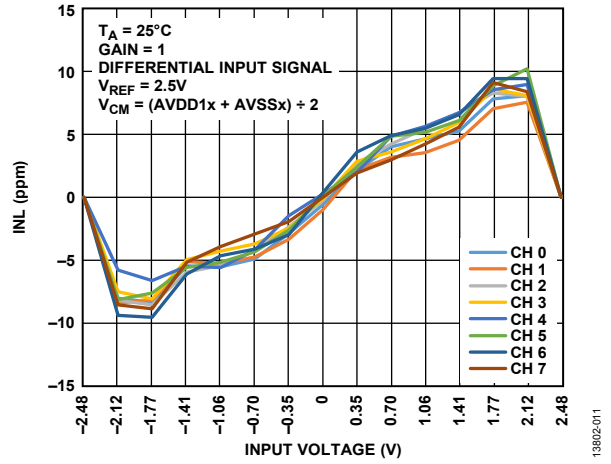

Figure 11. INL vs. Input Voltage and Channel at 16 kSPS, Low Power Mode

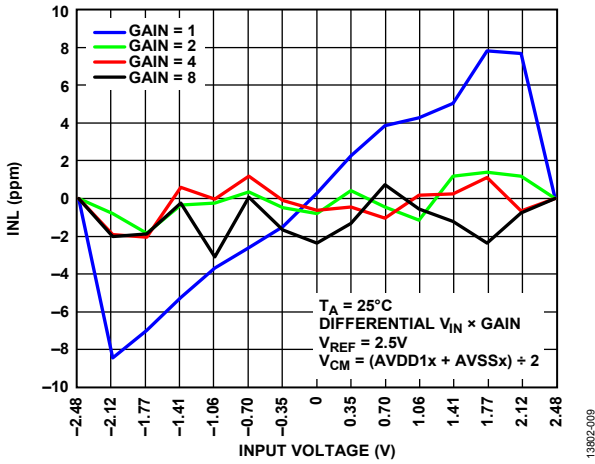

Figure 9. INL vs. Input Voltage and PGA Gain at 64 kSPS, High Resolution Mode

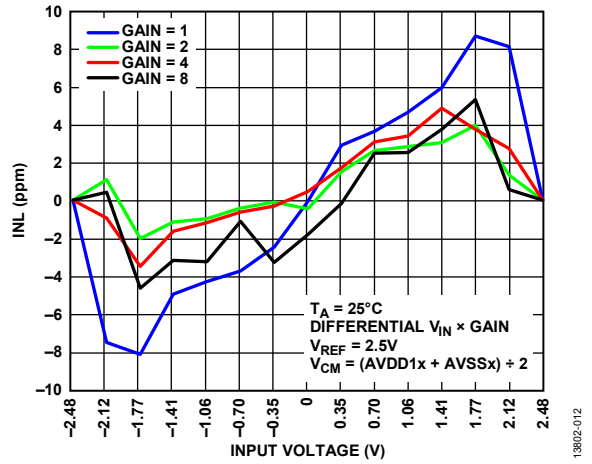

Figure 12. INL vs. Input Voltage and PGA Gain at 16 kSPS, Low Power Mode

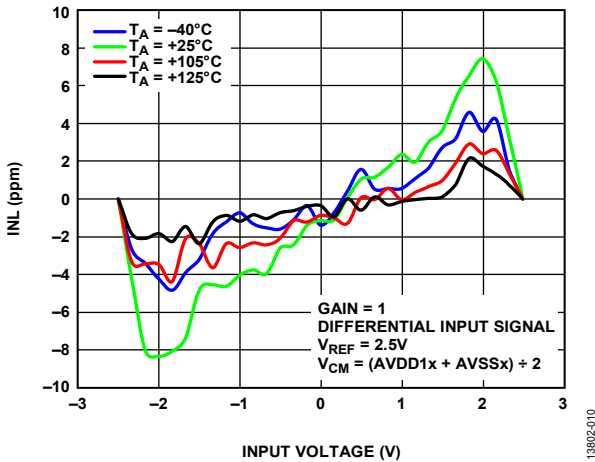

Figure 10. INL vs. Input Voltage and Temperature at 64 kSPS, High Resolution Mode

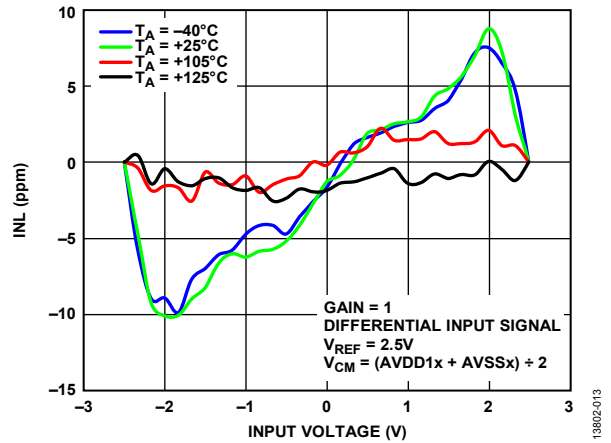

Figure 13. INL vs. Input Voltage and Temperature at 16 kSPS, Low Power Mode

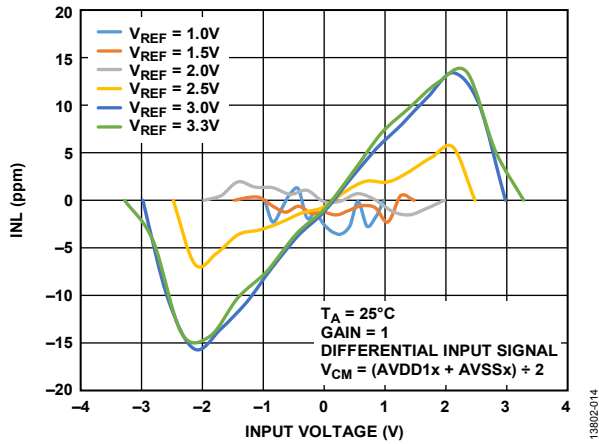

Figure 14. INL vs. Input Voltage and Reference Voltage (V_{REF}) at 64 kSPS, High Resolution Mode

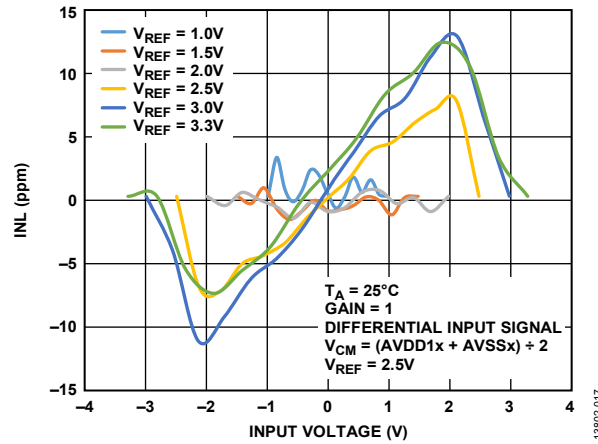

Figure 17. INL vs. Input Voltage and Reference Voltage (V_{REF}) at 16 kSPS, Low Power Mode

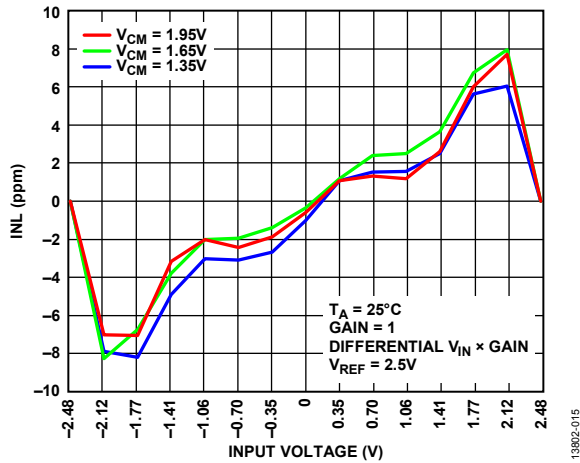

Figure 15. INL vs. Input Voltage and V_{CM} at 64 kSPS, High Resolution Mode

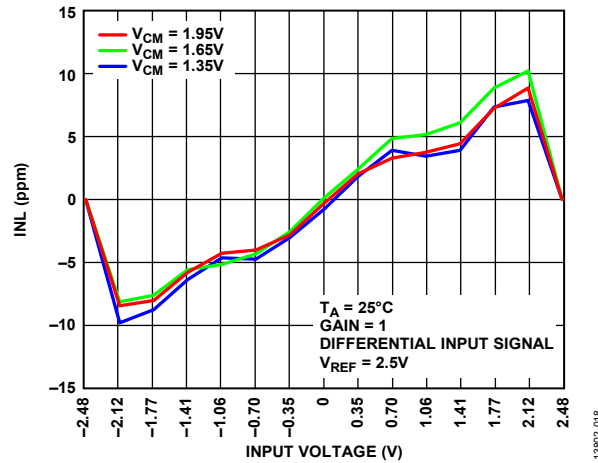

Figure 18. INL vs. Input Voltage and V_{CM} at 16 kSPS, Low Power Mode

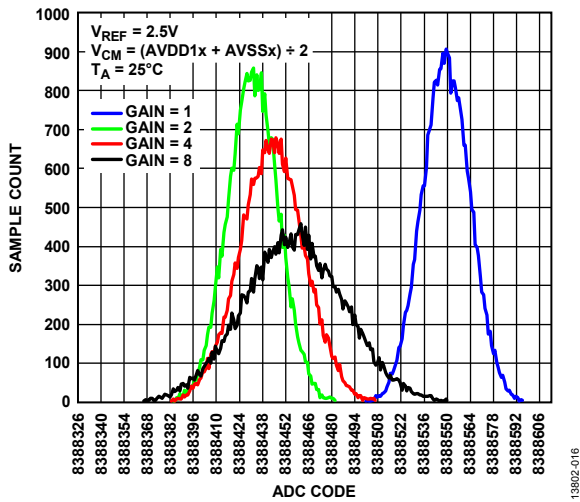

Figure 16. Noise Histogram at 16 kSPS, High Resolution Mode, Sinc3 Filter Enabled

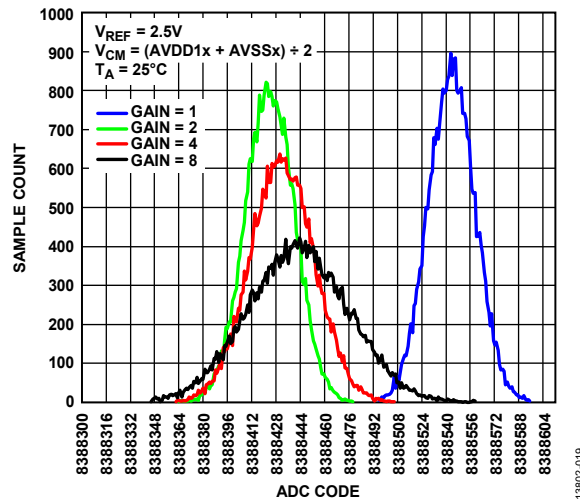

Figure 19. Noise Histogram at 4 kSPS, Low Power Mode, Sinc3 Filter Enabled

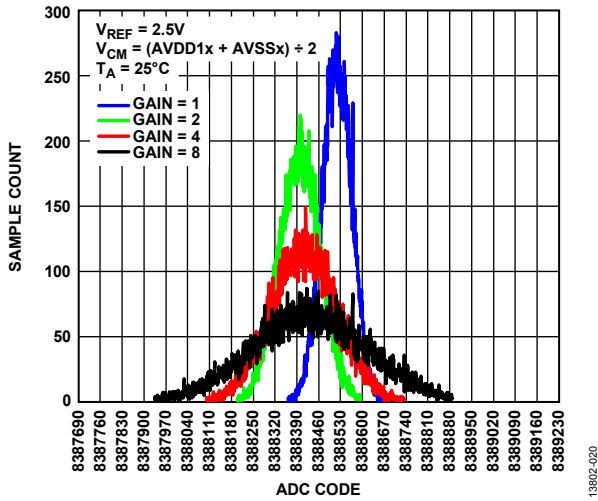

Figure 20. Noise Histogram at 64 kSPS, High Resolution Mode, Sinc5 Filter Enabled

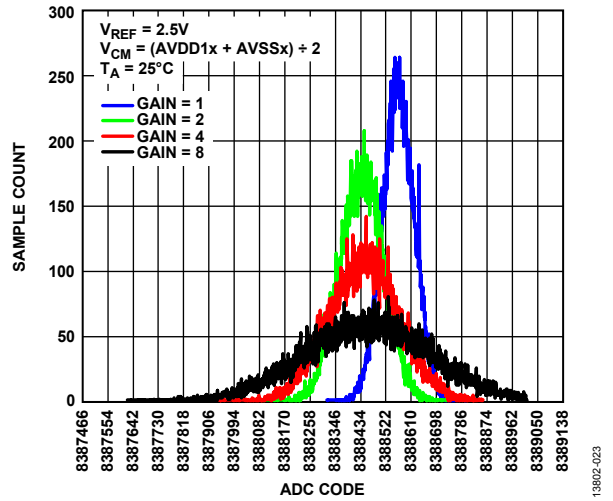

Figure 23. Noise Histogram at 16 kSPS, Low Power Mode, Sinc5 Filter Enabled

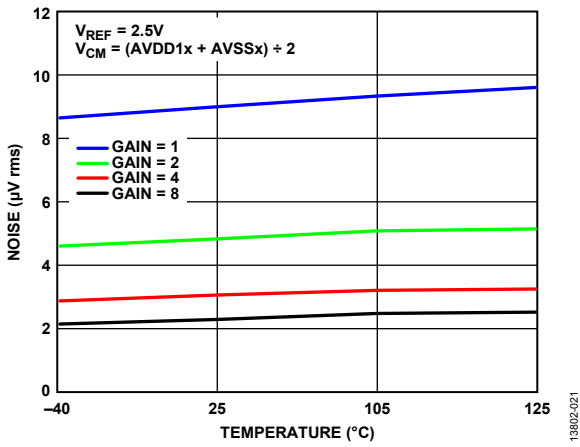

Figure 21. Noise vs. Temperature at 16 kSPS, High Resolution Mode, Sinc3 Filter Enabled

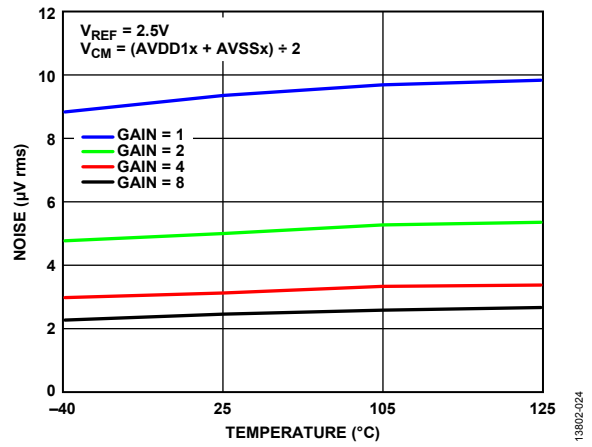

Figure 24. Noise vs. Temperature at 4 kSPS, Low Power Mode, Sinc3 Filter Enabled

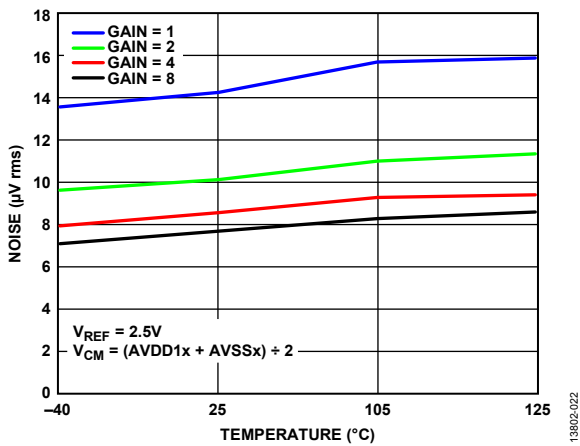

Figure 22. Noise vs. Temperature at 64 kSPS, High Resolution Mode, Sinc5 Filter Enabled

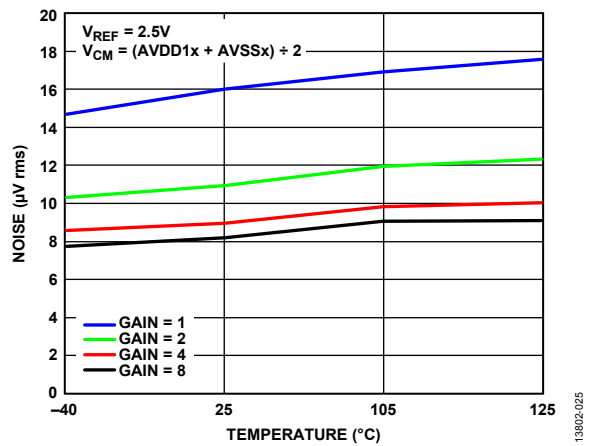

Figure 25. Noise vs. Temperature at 16 kSPS, Low Power Mode, Sinc5 Filter Enabled

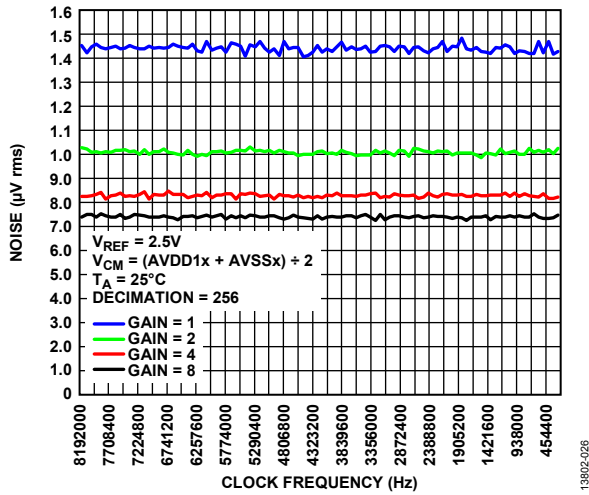

Figure 26. Noise vs. Clock Frequency, High Resolution Mode

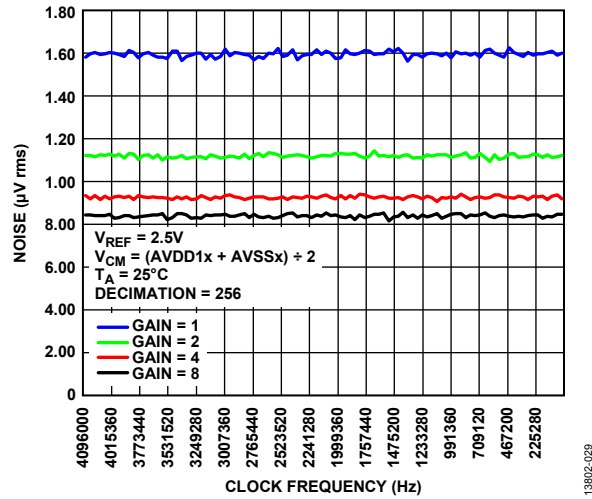

Figure 29. Noise vs. Clock Frequency, Low Power Mode

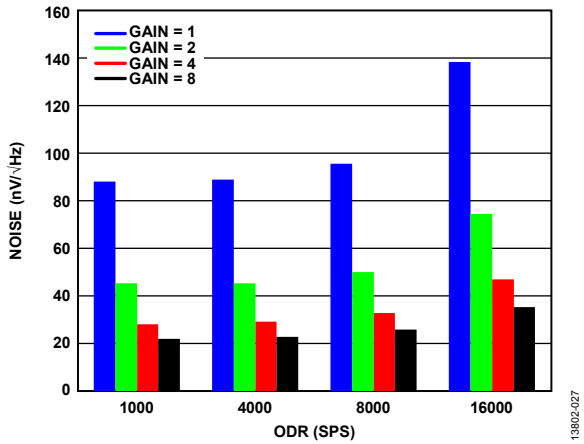

Figure 27. Noise vs. ODR, High Resolution Mode, Sinc3 Filter Enabled

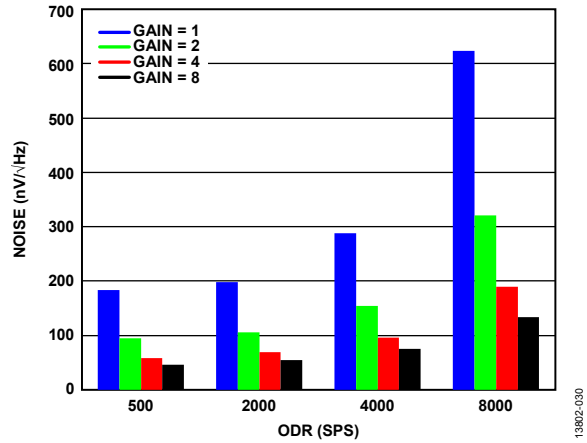

Figure 30. Noise vs. ODR, Low Power Mode, Sinc3 Filter Enabled

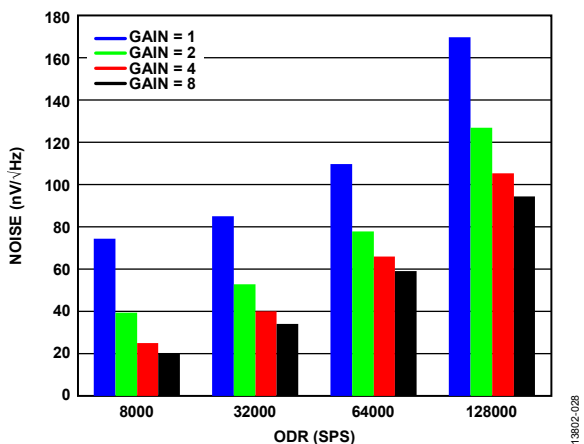

Figure 28. Noise vs. ODR, High Resolution Mode, Sinc5 Filter Enabled

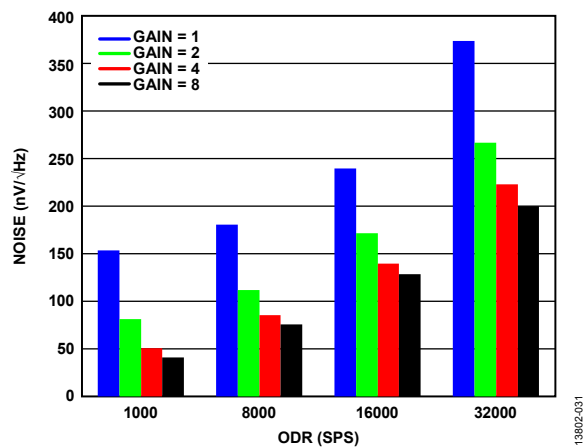

Figure 31. Noise vs. ODR, Low Power Mode, Sinc5 Filter Enabled

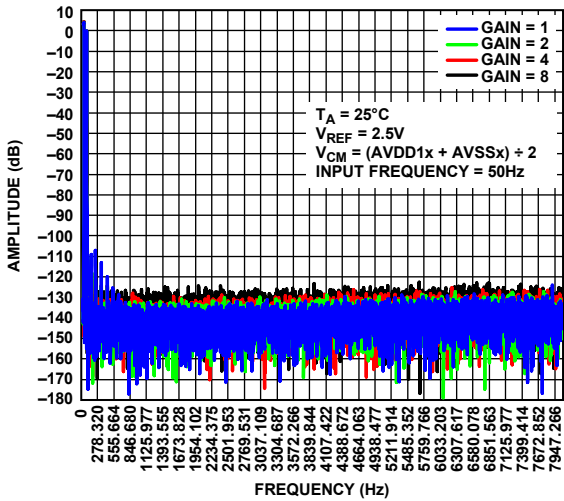

Figure 32. FFT Plot, High Resolution Mode at 16 kSPS, Input Frequency (f_{IN}) = 50 Hz, Sinc3 Filter Enabled

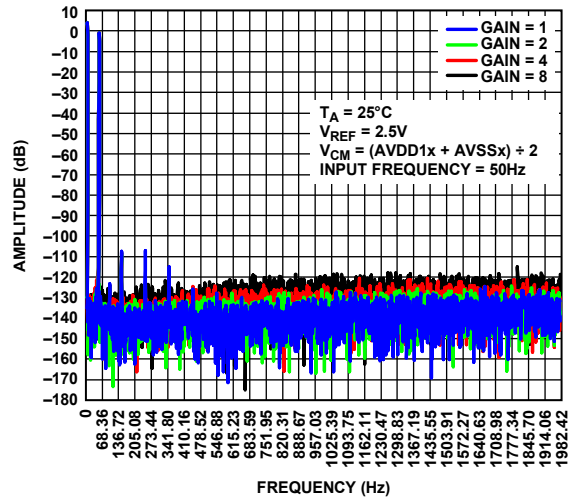

Figure 35. FFT Plot, Low Power Mode at 4 kSPS, Input Frequency (f_{IN}) = 50 Hz, Sinc3 Filter Enabled

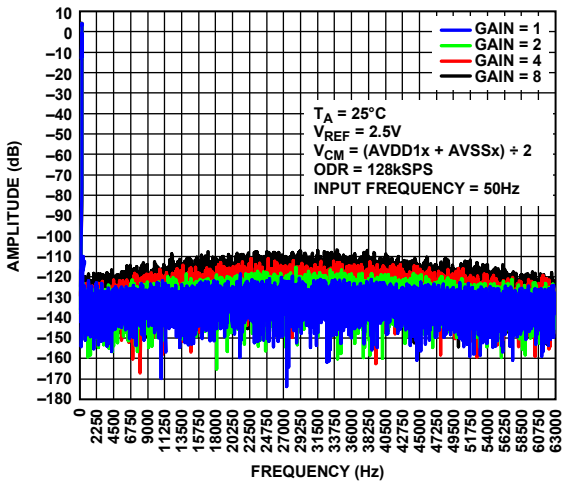

Figure 33. FFT Plot, High Resolution Mode at 128 kSPS, Input Frequency (f_{IN}) = 50 Hz, Sinc5 Filter Enabled

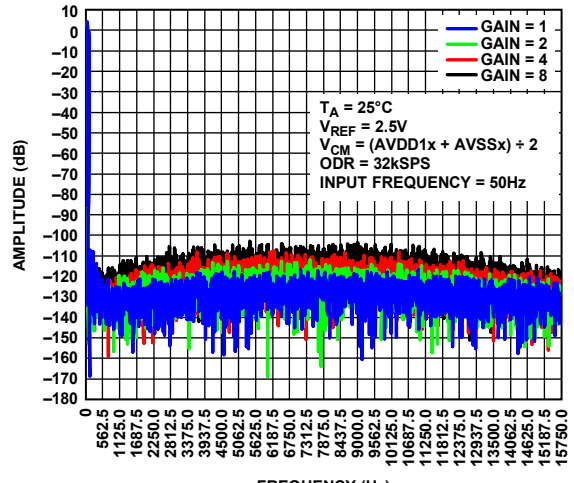

Figure 36. FFT Plot, Low Power Mode at 32 kSPS, Input Frequency (f_{IN}) = 50 Hz, Sinc5 Filter Enabled

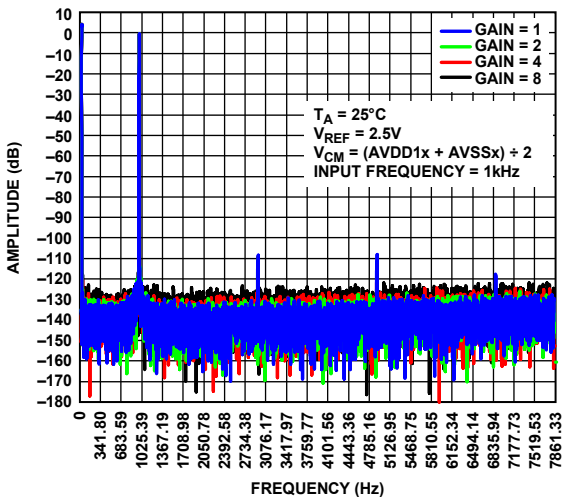

Figure 34. FFT Plot, High Resolution Mode at 16 kSPS, Input Frequency (f_{IN}) = 1 kHz, Sinc3 Filter Enabled

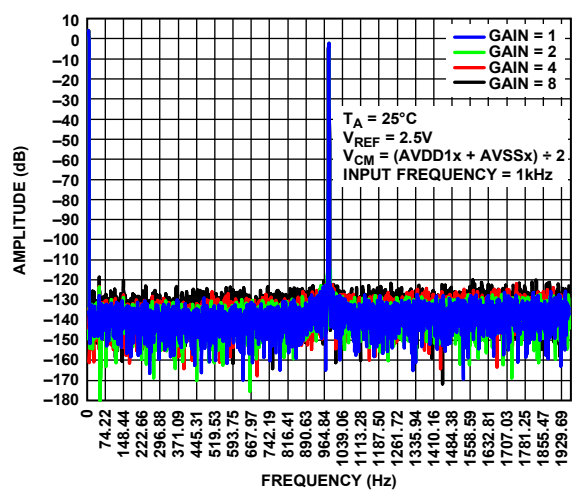

Figure 37. FFT Plot, Low Power Mode at 4 kSPS, Input Frequency (f_{IN}) = 1 kHz, Sinc3 Filter Enabled

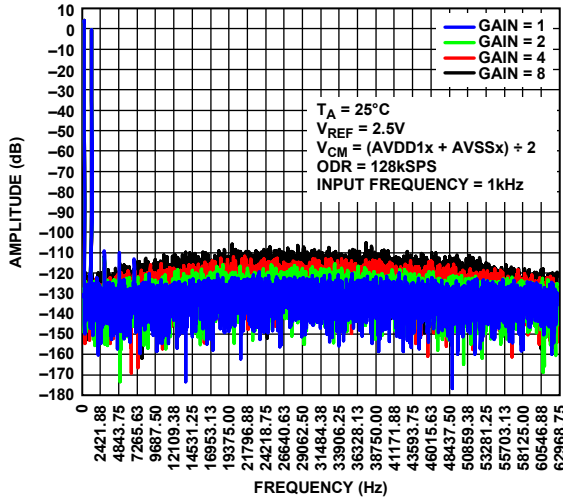

Figure 38. FFT Plot, High Resolution Mode at 128 kSPS, Input Frequency (f_{IN}) = 1 kHz, Sinc5 Filter Enabled

13802-038

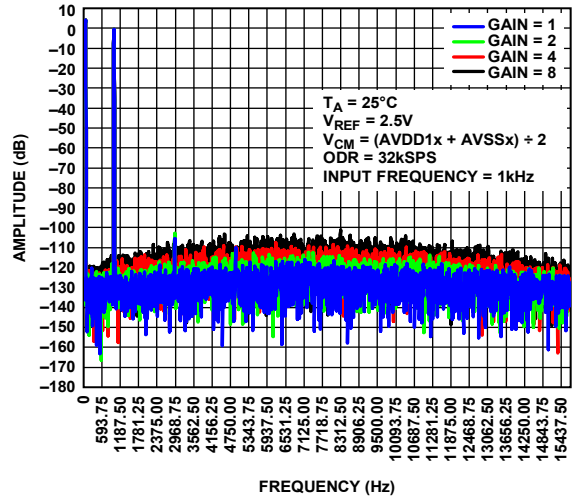

Figure 41. FFT Plot, Low Power Mode at 32 kSPS, Input Frequency (f_{IN}) = 1 kHz, Sinc5 Filter Enabled

13802-041

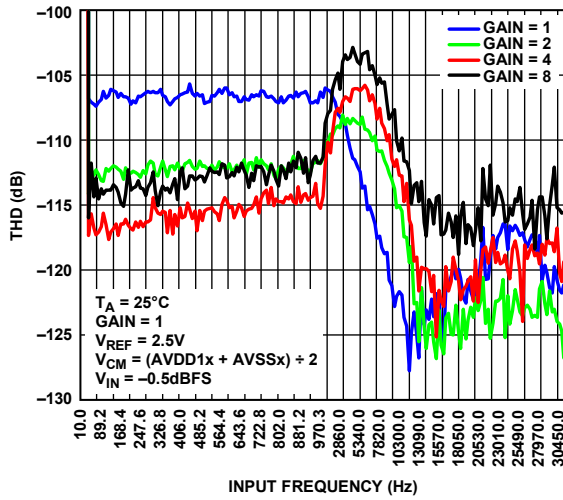

Figure 39. THD vs. Input Frequency at 64 kSPS, High Resolution Mode, Sinc5 Filter Enabled

13802-039

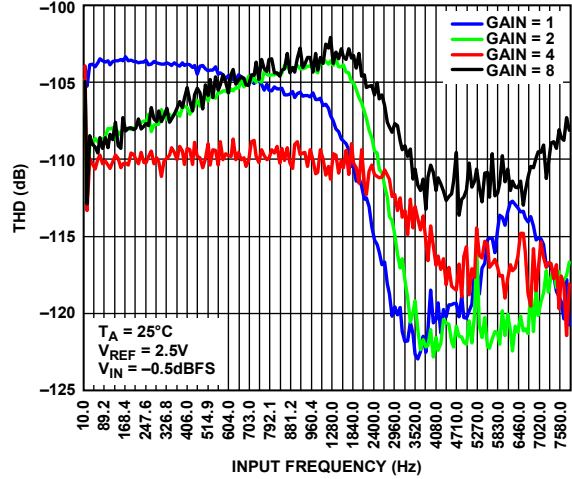

Figure 42. THD vs. Input Frequency at 16 kSPS, Low Power Mode, Sinc5 Filter Enabled

13802-042

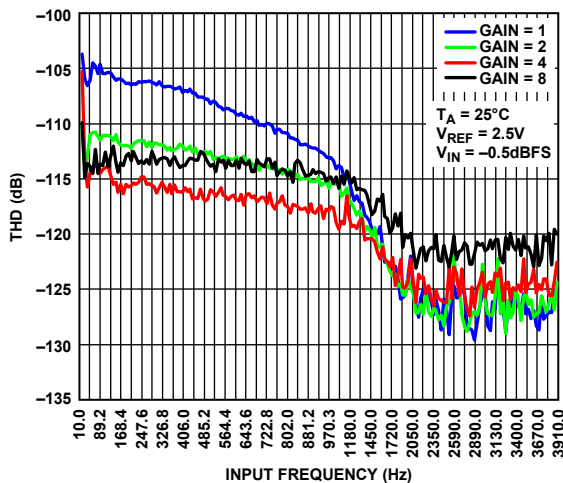

Figure 40. THD vs. Input Frequency at 16 kSPS, High Resolution Mode, Sinc3 Filter Enabled

13802-040

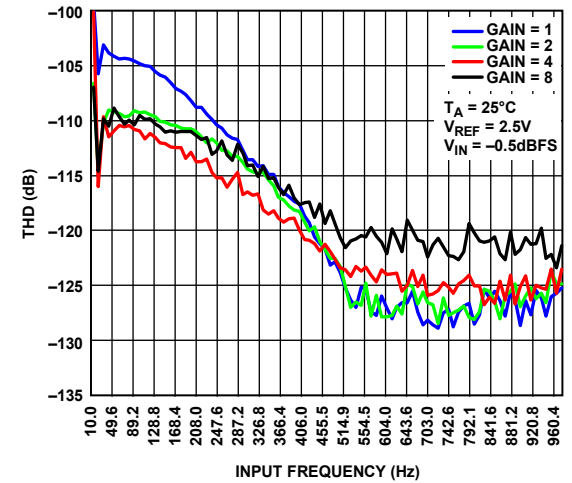

Figure 43. THD vs. Input Frequency at 4 kSPS, Low Power Mode, Sinc3 Filter Enabled

13802-043

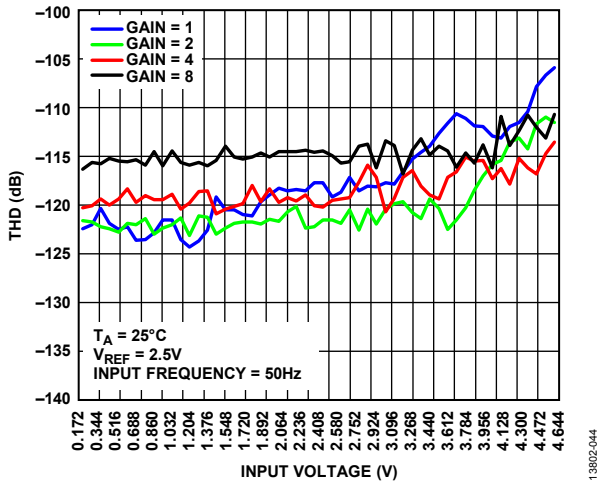

Figure 44. THD vs. Input Voltage at 64 kSPS, High Resolution Mode

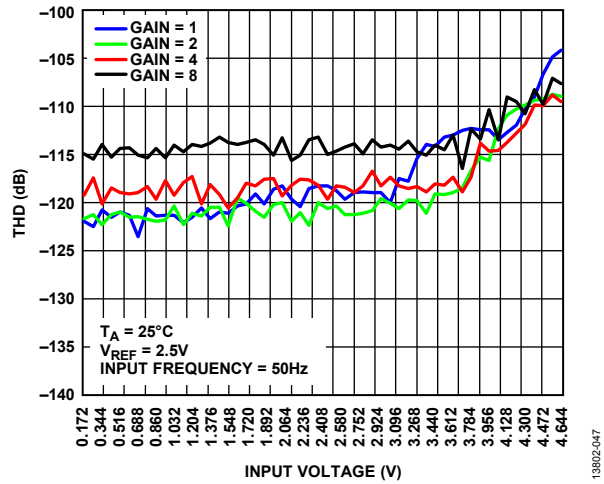

Figure 47. THD vs. Input Voltage at 16 kSPS, Low Power Mode

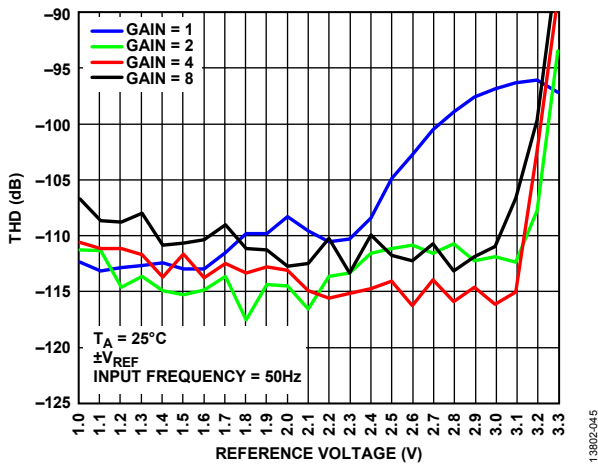

Figure 45. THD vs. Reference Voltage at 64 kSPS, High Resolution Mode

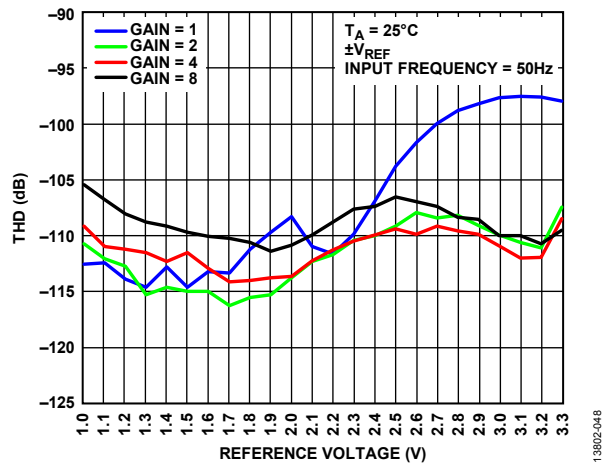

Figure 48. THD vs. Reference Voltage at 16 kSPS, Low Power Mode

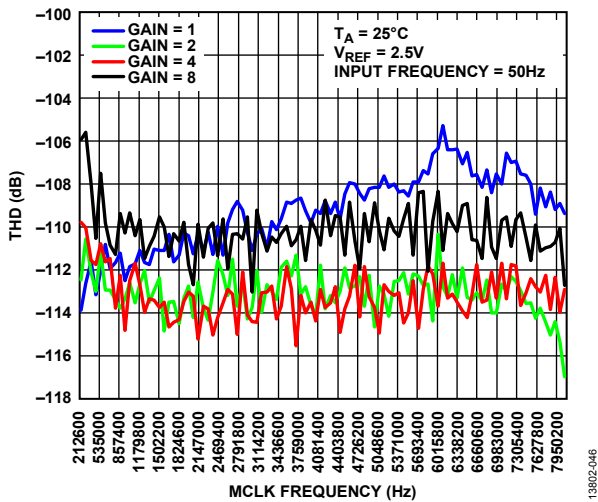

Figure 46. THD vs. Master Clock Frequency, High Resolution Mode

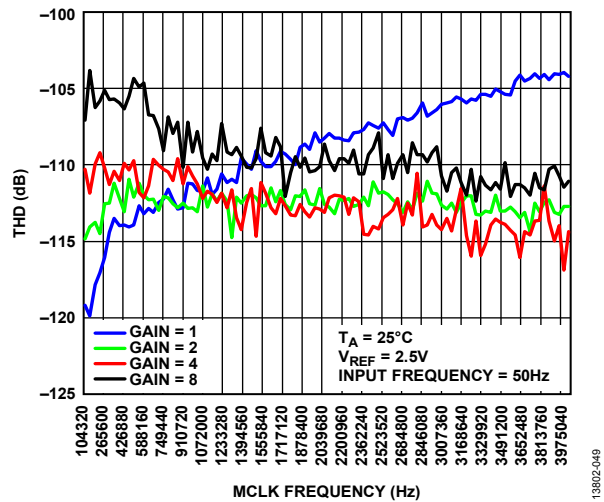

Figure 49. THD vs. Master Clock Frequency, Low Power Mode

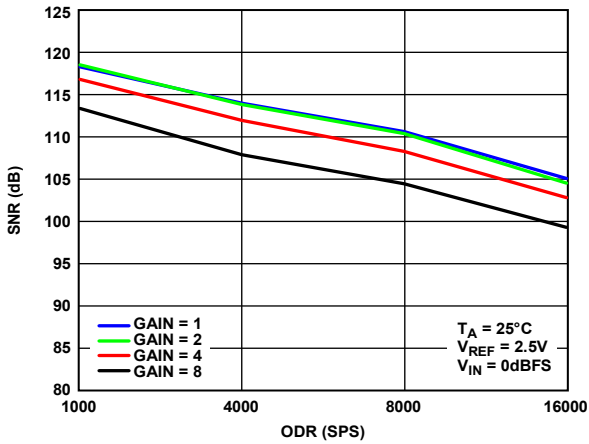

Figure 50. SNR vs. ODR at 16 kSPS, High Resolution Mode (AVDDx = 3.6 V, IOVDD = 3.6 V)

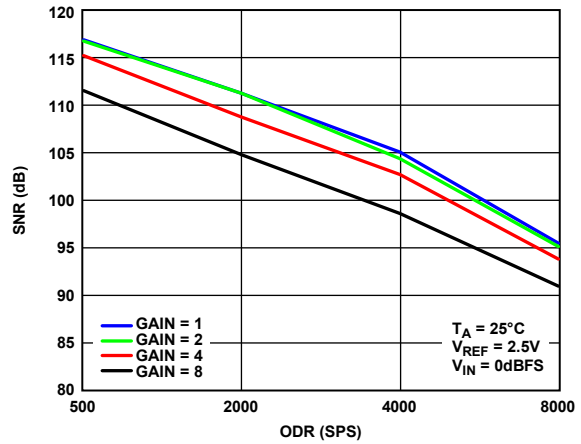

Figure 53. SNR vs. ODR at 4 kSPS, Low Power Mode (AVDDx = 3.6 V, IOVDD = 3.6 V)

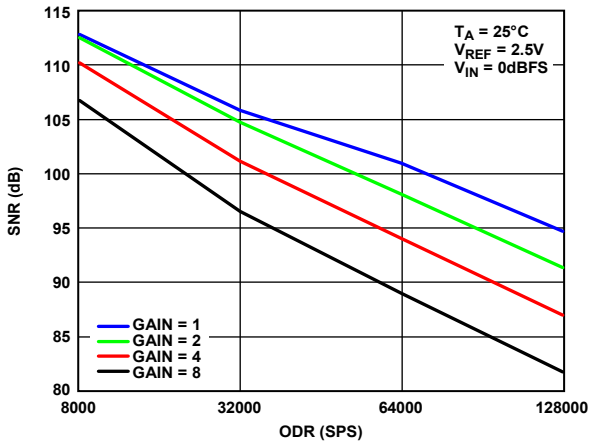

Figure 51. SNR vs. ODR at 64 kSPS, High Resolution Mode (AVDDx = 3.6 V, IOVDD = 3.6 V)

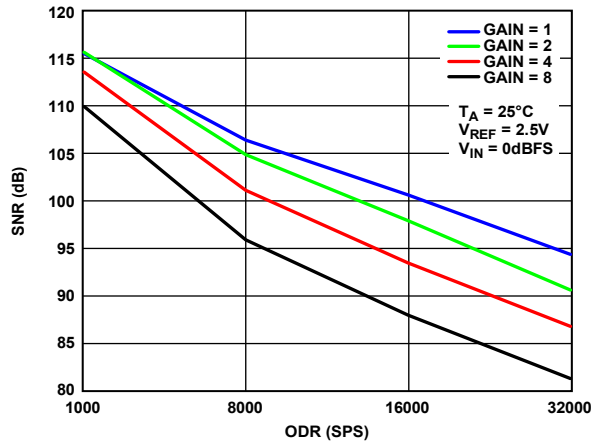

Figure 54. SNR vs. ODR at 16 kSPS, Low Power Mode (AVDDx = 3.6 V, IOVDD = 3.6 V)

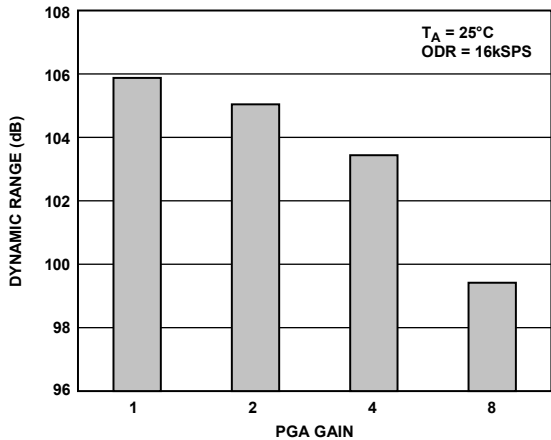

Figure 52. Dynamic Range vs. PGA Gain at 16 kSPS, High Resolution Mode

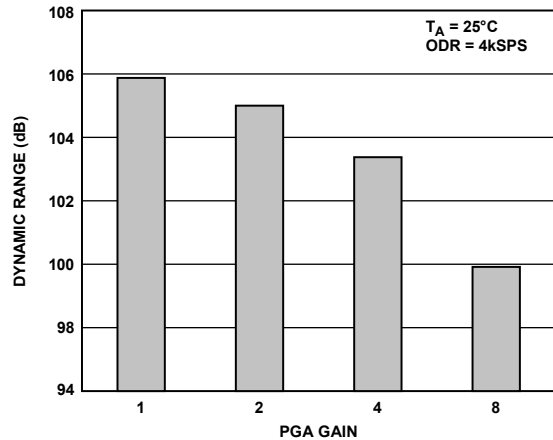

Figure 55. Dynamic Range vs. PGA Gain at 4 kSPS, Low Power Mode

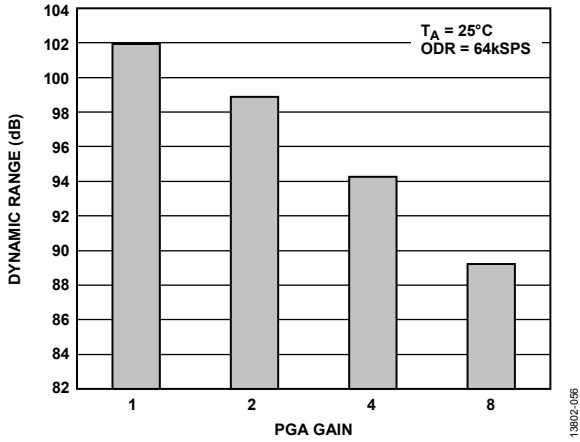

Figure 56. Dynamic Range vs. PGA Gain at 64 kSPS, High Resolution Mode

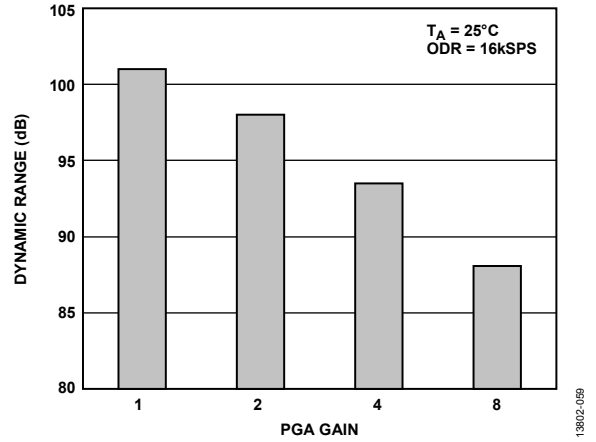

Figure 59. Dynamic Range vs. PGA Gain at 16 kSPS, Low Power Mode

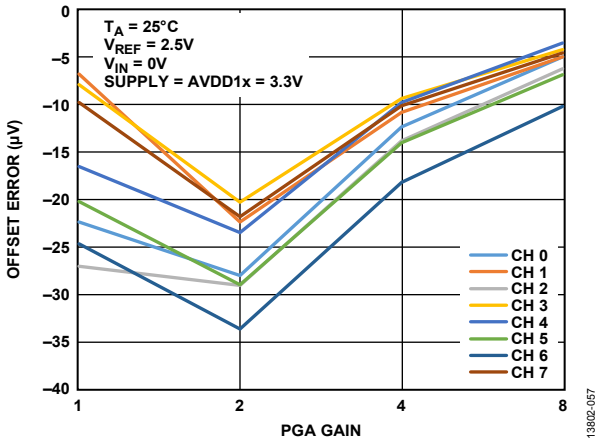

Figure 57. Offset Error vs. PGA Gain at 64 kSPS, High Resolution Mode

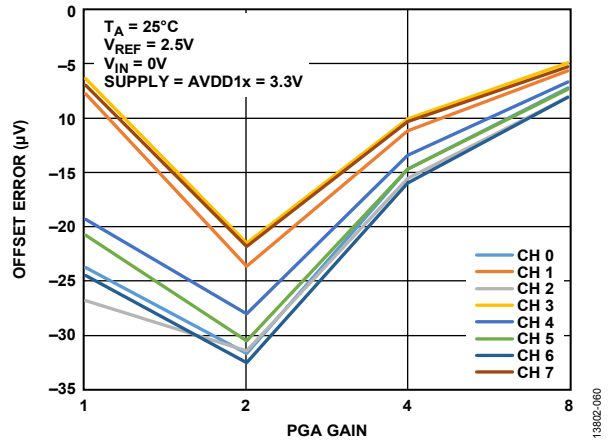

Figure 60. Offset Error vs. PGA Gain at 16 kSPS, Low Power Mode

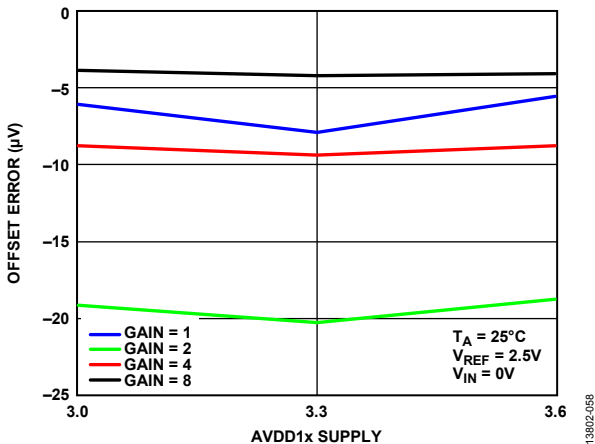

Figure 58. Offset Error vs. AVDD1x Supply, High Resolution Mode

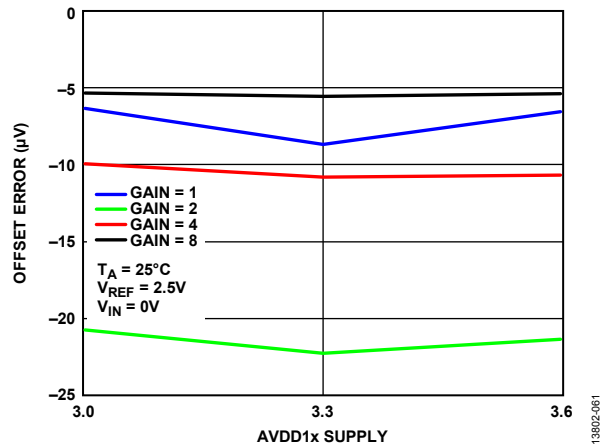

Figure 61. Offset Error vs. AVDD1x Supply, Low Power Mode

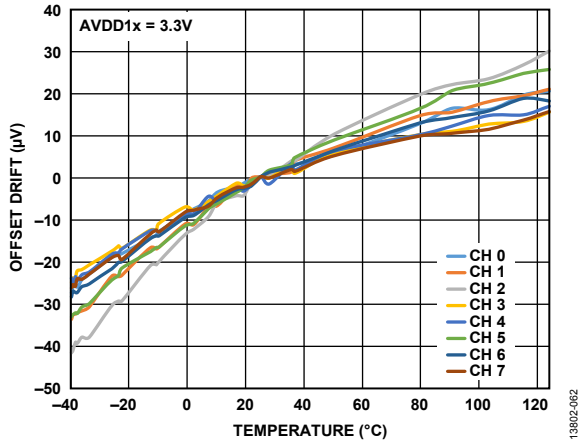

Figure 62. Offset Drift vs. Temperature

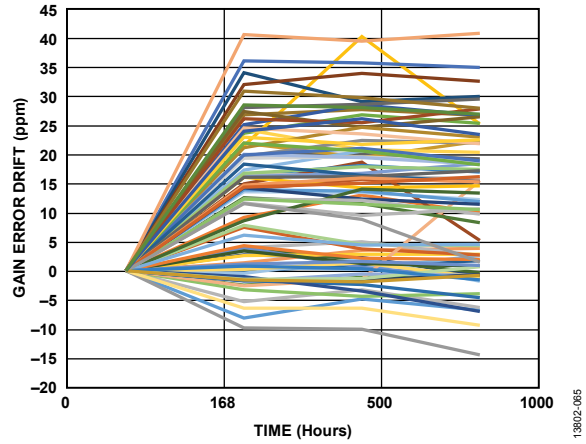

Figure 65. Gain Error Drift vs. Time

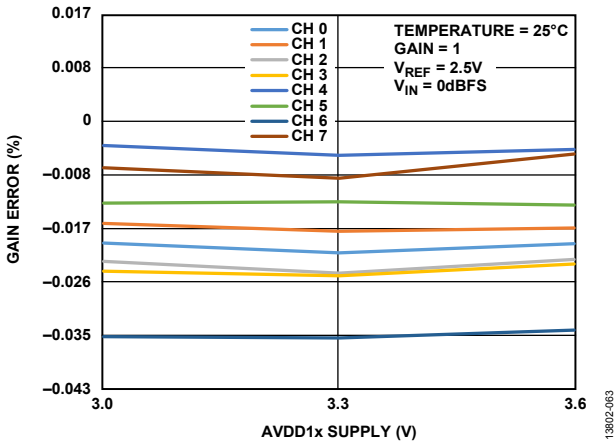

Figure 63. Gain Error vs. AVDD1x Supply, High Resolution Mode

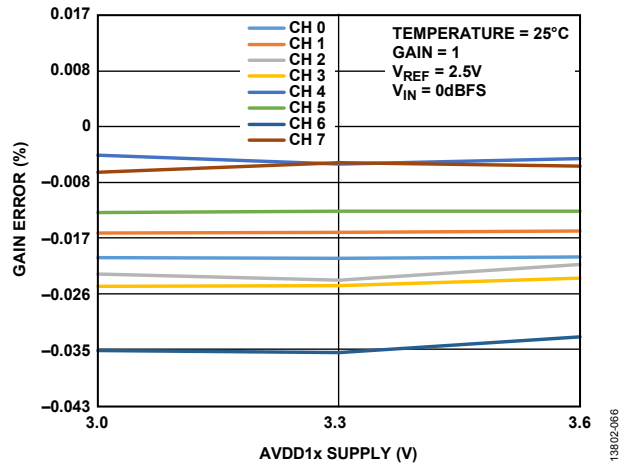

Figure 66. Gain Error vs. AVDD1x Supply, Low Power Mode

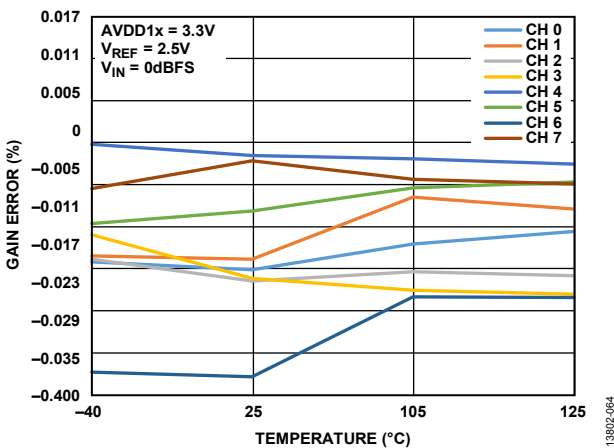

Figure 64. Gain Error vs. Temperature, High Resolution Mode

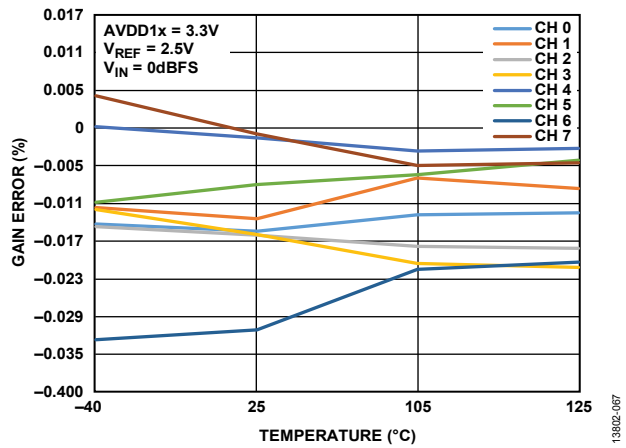

Figure 67. Gain Error vs. Temperature, Low Power Mode

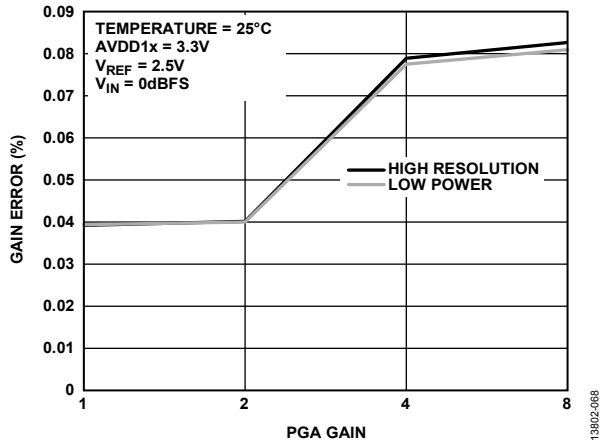

Figure 68. Channel Gain Mismatch

13802-068

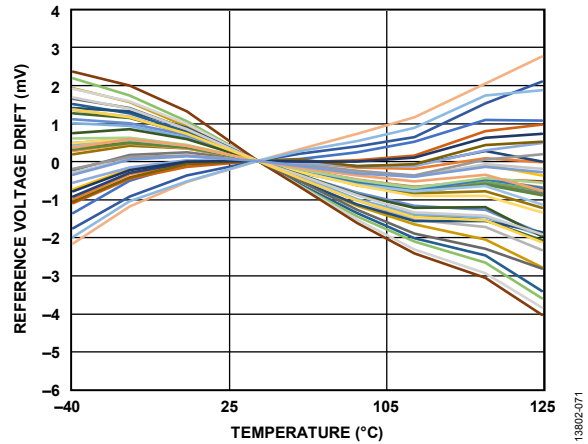

Figure 71. Internal Reference Voltage Drift

13802-071

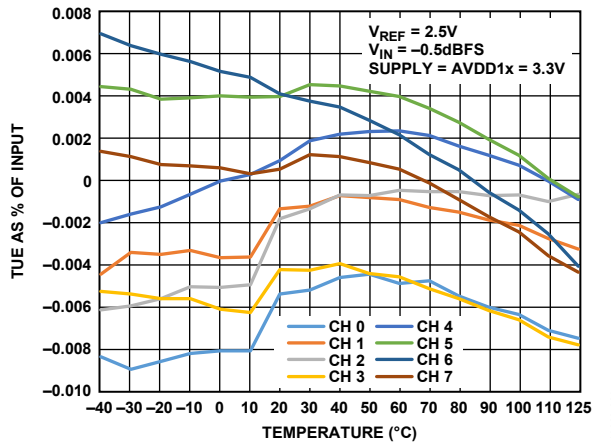

Figure 69. Total Unadjusted Error (TUE) (as Percent of Input) vs. Temperature, High Resolution Mode

13802-069

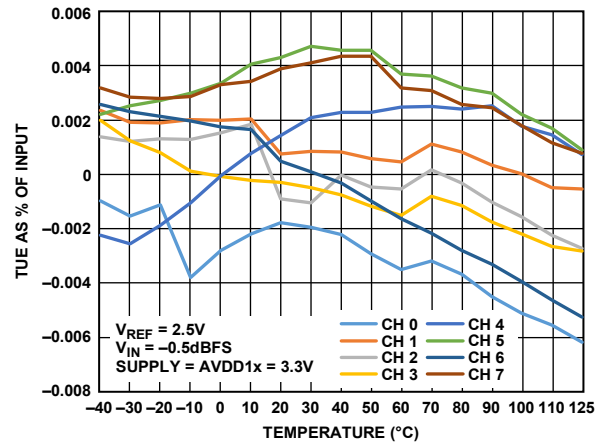

Figure 72. Total Unadjusted Error (TUE) (as Percent of Input) vs. Temperature, Low Power Mode

13802-072

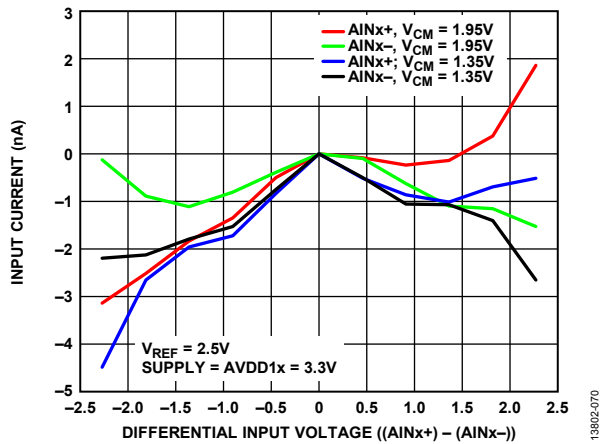

Figure 70. Input Current vs. Differential Input Voltage, High Resolution Mode

13802-070

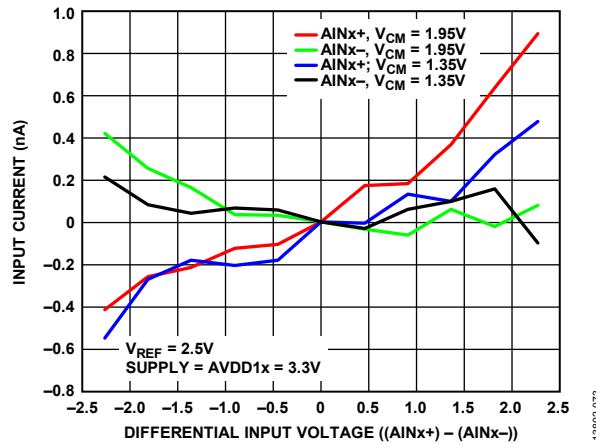

Figure 73. Input Current vs. Differential Input Voltage, Low Power Mode

13802-073

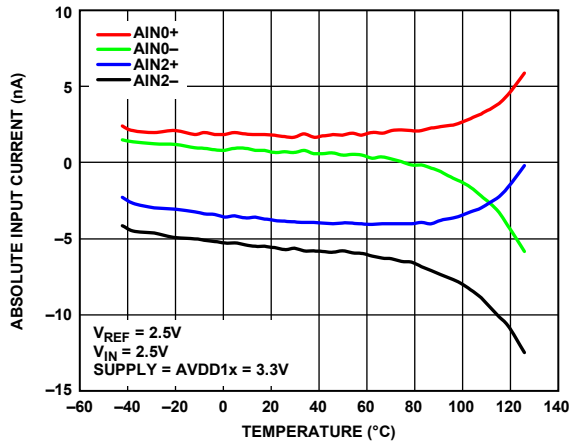

Figure 74. Absolute Input Current vs. Temperature, High Resolution Mode

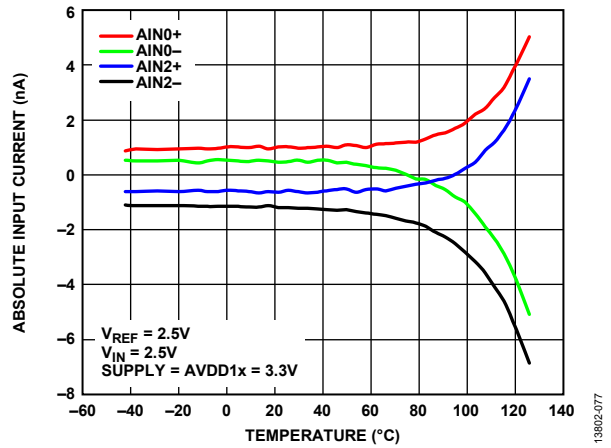

Figure 77. Absolute Input Current vs. Temperature, Low Power Mode

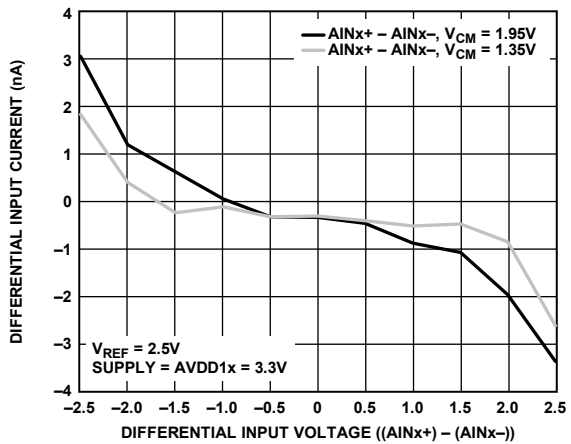

Figure 75. Differential Input Current vs. Differential Input Voltage, High Resolution Mode

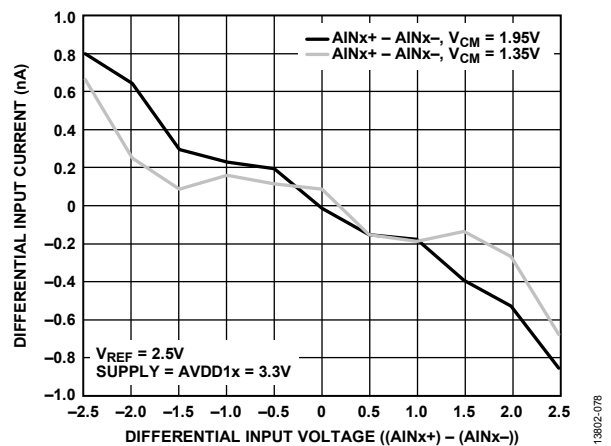

Figure 78. Differential Input Current vs. Differential Input Voltage, Low Power Mode

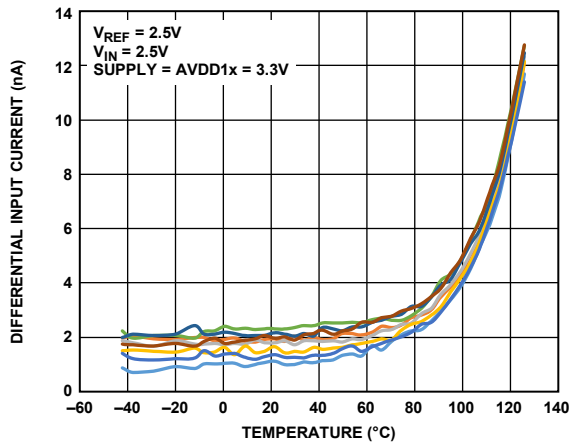

Figure 76. Differential Input Current vs. Temperature, High Resolution Mode

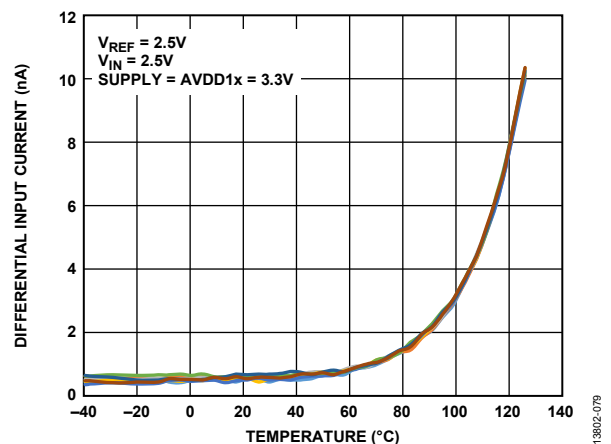

Figure 79. Differential Input Current vs. Temperature, Low Power Mode

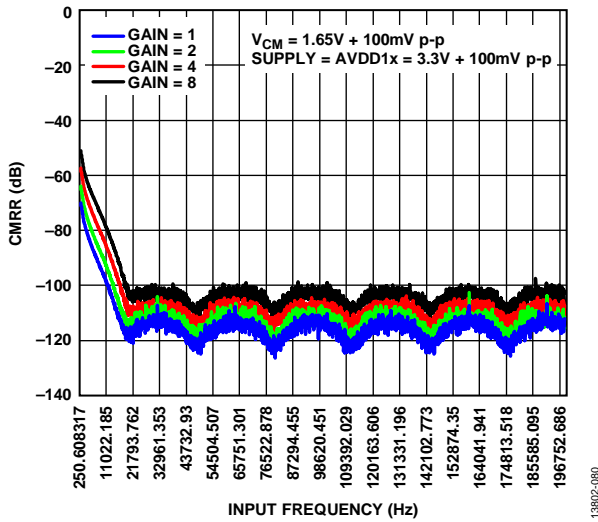

Figure 80. CMRR vs. Input Frequency at 128 kSPS, High Resolution Mode

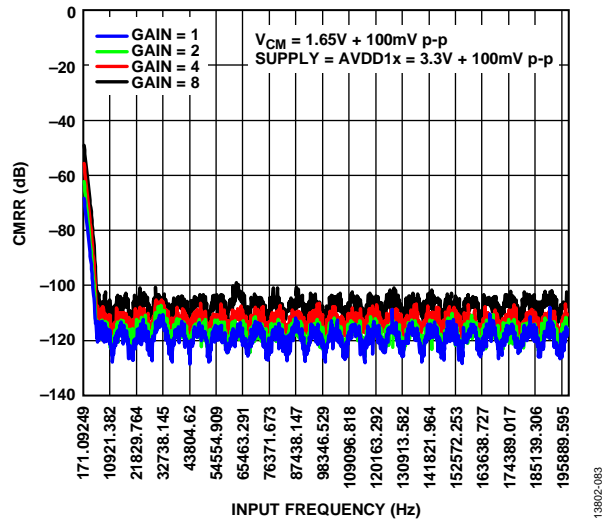

Figure 83. CMRR vs. Input Frequency at 32 kSPS, Low Power Mode

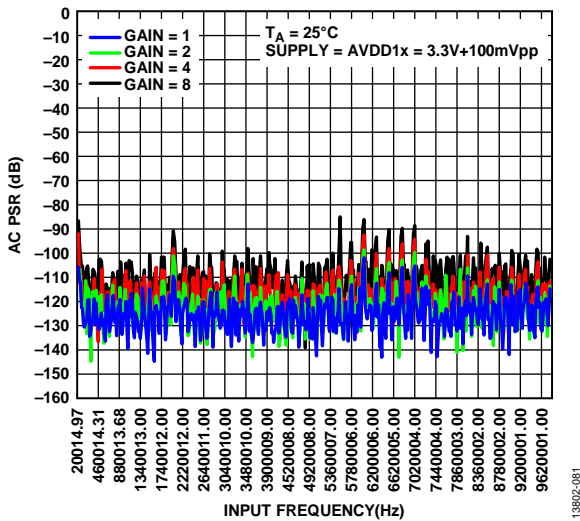

Figure 81. AC PSRR vs. Input Frequency at 128 kSPS, High Resolution Mode

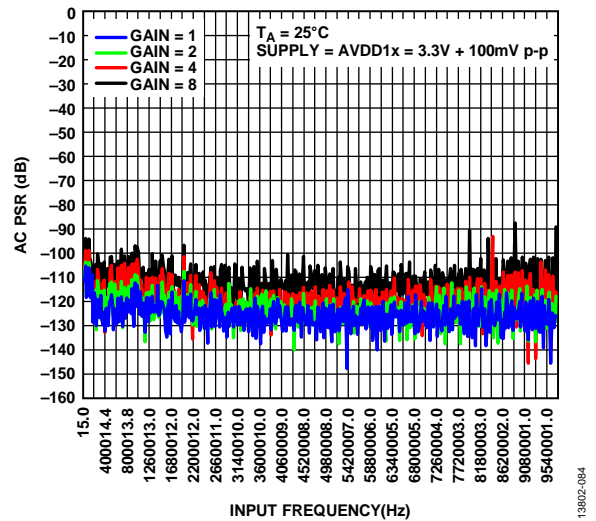

Figure 84. AC PSRR vs. Input Frequency at 32 kSPS, Low Power Mode

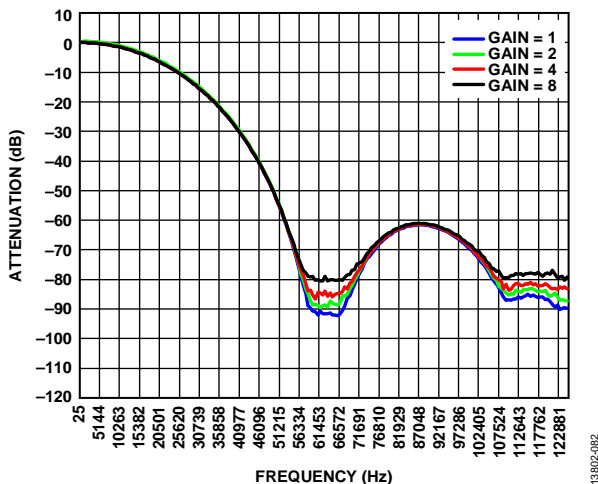

Figure 82. Filter Profiles at 64 kSPS, High Resolution Mode

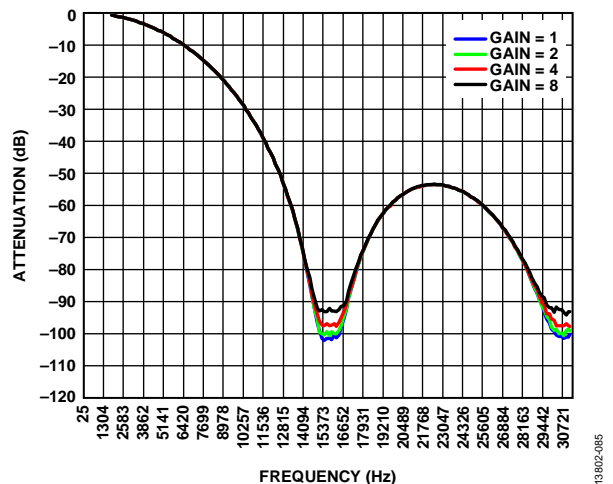

Figure 85. Filter Profiles at 16 kSPS, Low Power Mode

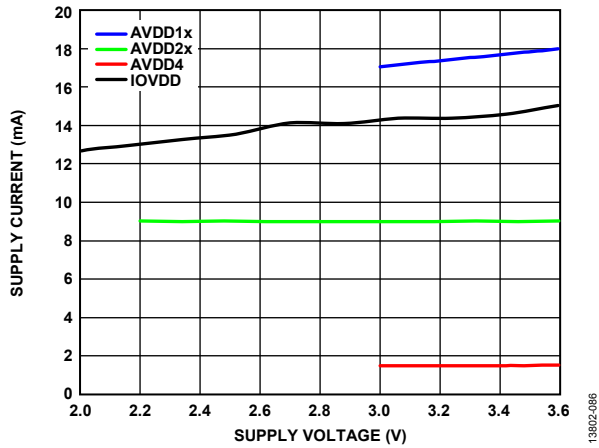

Figure 86. Supply Current vs. Supply Voltage, High Resolution Mode

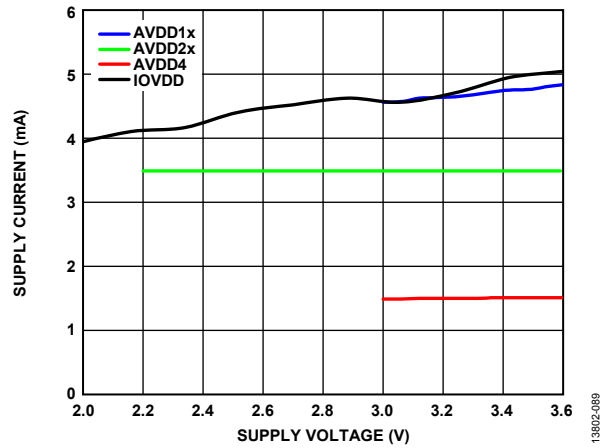

Figure 89. Supply Current vs. Supply Voltage, Low Power Mode

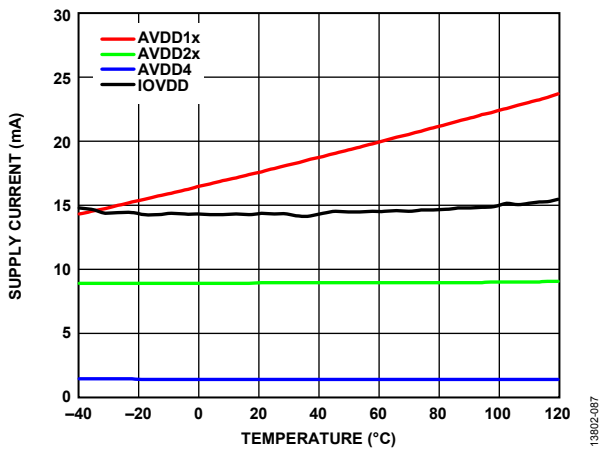

Figure 87. Supply Current vs. Temperature High Resolution Mode

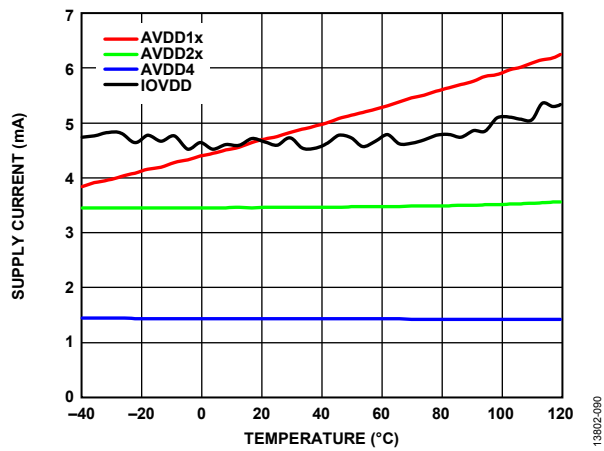

Figure 90. Supply Current vs. Temperature Low Power Mode

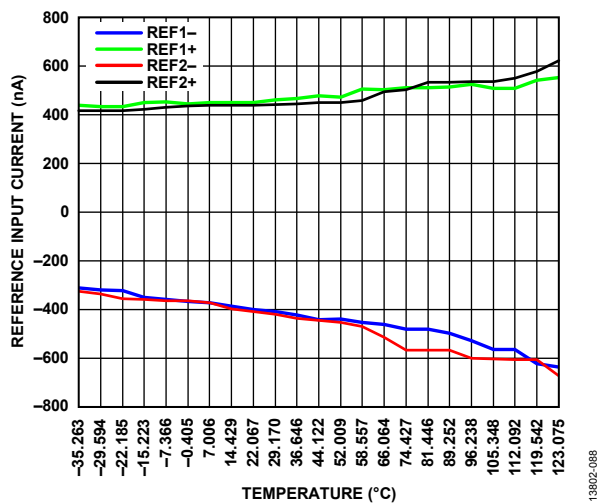

Figure 88. Reference Input Current vs. Temperature, High Resolution Mode

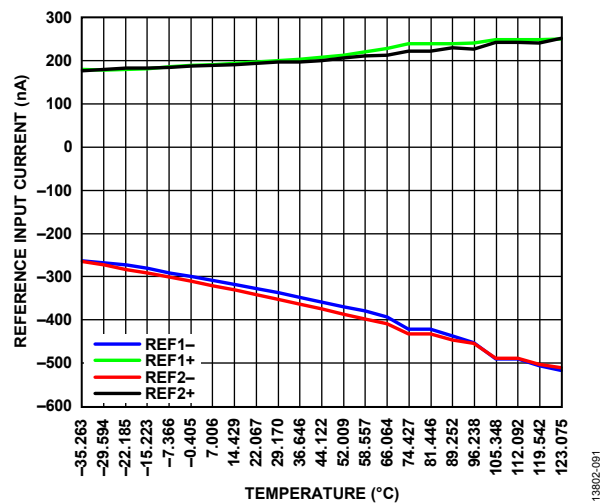

Figure 91. Reference Input Current vs. Temperature, Low Power Mode

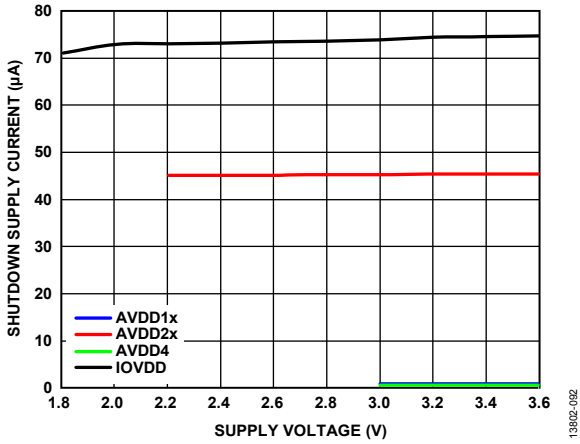

Figure 92. Shutdown Supply Current vs. Supply Voltage

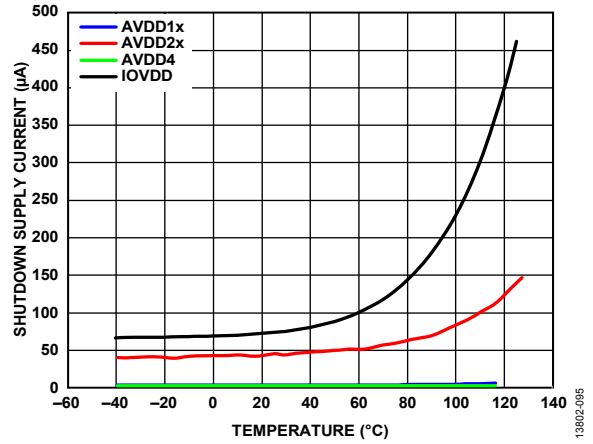

Figure 95. Shutdown Supply Current vs. Temperature

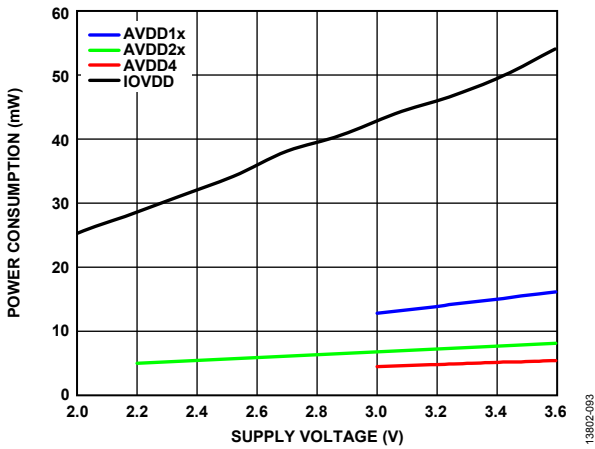

Figure 93. Power Consumption per Channel vs. Supply Voltage, High Resolution Mode

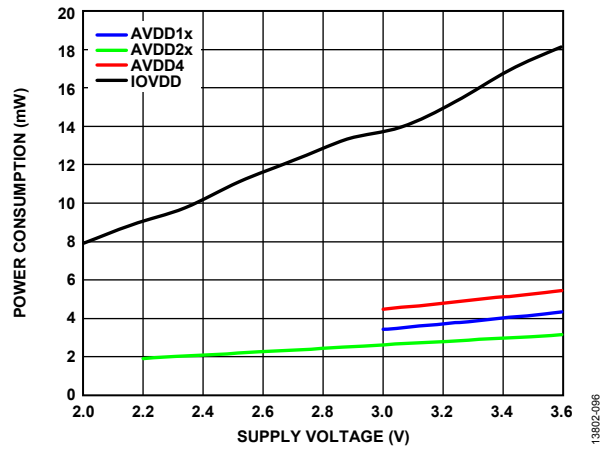

Figure 96. Power Consumption per Channel vs. Supply Voltage, Low Power Mode

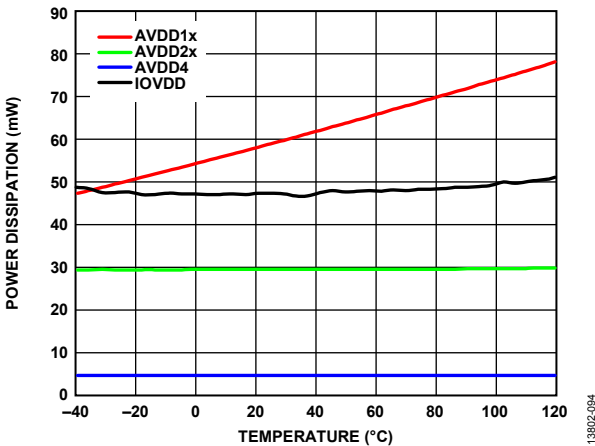

Figure 94. Power Dissipation vs. Temperature, High Resolution Mode

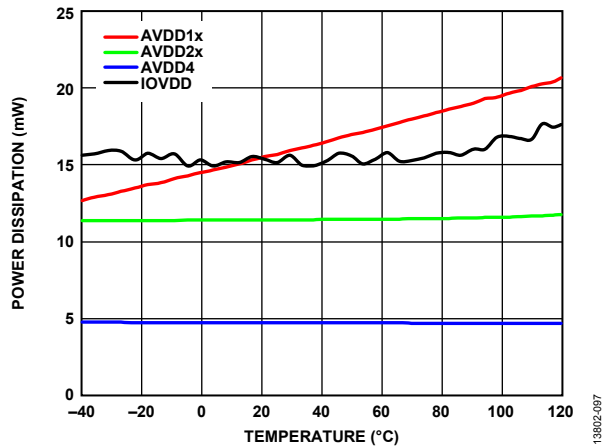

Figure 97. Power Dissipation vs. Temperature, Low Power Mode

TERMINOLOGY

Common-Mode Rejection Ratio (CMRR)

CMRR is the ratio of the power in the ADC output at full-scale frequency, f , to the power of a 100 mV p-p sine wave applied to the common-mode voltage of AINx+ and AINx- at frequency, f_s .

$$CMRR \text{ (dB)} = 10 \log(P_f/P_{f_s})$$

where:

P_f is the power at frequency, f , in the ADC output.

P_{f_s} is the power at frequency, f_s , in the ADC output.

Differential Nonlinearity (DNL) Error

In an ideal ADC, code transitions are 1 LSB apart. Differential nonlinearity is the maximum deviation from this ideal value. DNL error is often specified in terms of resolution for which no missing codes are guaranteed.

Integral Nonlinearity (INL) Error

Integral nonlinearity error refers to the deviation of each individual code from a line drawn from negative full scale through positive full scale. The point used as negative full scale occurs ½ LSB before the first code transition. Positive full scale is a level 1½ LSB beyond the last code transition. The deviation is measured from the middle of each code to the true straight line.

Dynamic Range

Dynamic range is the ratio of the rms value of the full-scale input signal to the rms noise measured for an input. The value for dynamic range is expressed in decibels.

Channel to Channel Isolation

Channel to channel isolation is a measure of the level of crosstalk between channels. It is measured by applying a full-scale frequency sweep sine wave signal to all seven unselected input channels and determining how much that signal is attenuated in the selected channel. The value is given for worst case scenarios across all eight channels of the AD7771.

Intermodulation Distortion

With inputs consisting of sine waves at two frequencies, f_A and f_B , any active device with nonlinearities creates distortion products at the sum and difference frequencies of mf_A and nf_B , where $m, n = 0, 1, 2, 3$, and so on. Intermodulation distortion terms are those for which neither m nor n are equal to 0. For example, the second-order terms include $(f_A + f_B)$ and $(f_A - f_B)$ and the third-order terms include $(2f_A + f_B)$, $(2f_A - f_B)$, $(f_A + 2f_B)$, and $(f_A - 2f_B)$. The AD7771 is tested using the CCIF standard, where two input frequencies near the top end of the input bandwidth are used. In this case, the second-order terms are usually distanced in frequency from the original sine waves, and the third-order terms are usually at a frequency close to the input frequencies. As a result, the second-order and third-order terms are specified separately. The calculation of the intermodulation distortion is per the THD specification, where it is the ratio of the rms sum of the individual distortion products to the rms amplitude of the sum of the fundamentals, expressed in decibels.

Gain Error

The first transition (from 100 ... 000 to 100 ... 001) occurs at a level ½ LSB above nominal negative full scale (-2.49999 V for the ± 2.5 V range). The last transition (from 011 ... 110 to 011 ... 111) occurs for an analog voltage 1½ LSB below the nominal full scale (2.49999 V for the ± 2.5 V range). The gain error is the deviation of the difference between the actual level of the last transition and the actual level of the first transition from the difference between the ideal levels.

Gain Error Drift

Gain error drift is the ratio of the gain error change due to a temperature change of 1°C and the full-scale range (2^N). It is expressed in ppm/°C.

Least Significant Bit (LSB)

The least significant bit, or LSB, is the smallest increment that can be represented by a converter. For a fully differential input ADC with N bits of resolution, the LSB expressed in volts is

$$LSB \text{ (V)} = \frac{2 \times V_{REF}}{2^N}$$

The LSB referred to the input is

$$LSB (V_{IN}) = \frac{2 \times V_{REF}}{2^N} \frac{PGA_{GAIN}}{2^N}$$

Power Supply Rejection Ratio (PSRR)

Variations in power supply affect the full-scale transition but not the linearity of the converter. PSRR is the maximum change in the full-scale transition point due to a change in the power supply voltage from the nominal value.

Signal-to-Noise Ratio (SNR)

SNR is the ratio of the rms value of the actual input signal to the rms sum of all other spectral components below the Nyquist frequency, excluding harmonics and dc. The value for SNR is expressed in decibels.

Signal-to-(Noise + Distortion) Ratio (SINAD)

SINAD is the ratio of the rms value of the actual input signal to the rms sum of all other spectral components below the Nyquist frequency, including harmonics but excluding dc. The value for SINAD is expressed in decibels.

Spurious-Free Dynamic Range (SFDR)

SFDR is the difference, in decibels, between the rms amplitude of the input signal and the peak spurious signal including harmonics.

Total Harmonic Distortion (THD)

THD is the ratio of the rms sum of the first five harmonic components to the rms value of a full-scale input signal and is expressed in decibels.

Offset Error

Offset error is the difference between the ideal midscale input voltage (0 V) and the actual voltage producing the midscale output code.

Offset Error Drift

Offset error drift is the ratio of the offset error change due to a temperature change of 1°C and the full-scale code range (2^N). It is expressed in $\mu\text{V}/^\circ\text{C}$.

THEORY OF OPERATION

The AD7771 is an 8-channel, simultaneously sampling, low noise, 24-bit Σ - Δ ADC with integrated digital filtering per channel and SRC.

The AD7771 offers two operation modes: high resolution mode, which offers up to 128 kSPS, and low power mode, which offers up to 32 kSPS.

The AD7771 employs a Σ - Δ conversion technique to convert the analog input signal into an equivalent digital word. The overview of the Σ - Δ technique is that the modulator samples the input waveform and outputs an equivalent digital word at the input clock frequency, f_{CLKIN} .

Due to the high oversampling rate, this technique spreads the quantization noise from 0 Hz to $f_{CLKIN}/2$ (in the case of the AD7771, f_{CLKIN} relates to the external clock); therefore, the noise energy contained in the band of interest is reduced (see Figure 98). To further reduce the quantization noise, a high order modulator is employed to shape the noise spectrum so that most of the noise energy is shifted out of the band of interest (see Figure 99). The digital filter that follows the modulator removes the large out of band quantization noise (see Figure 100).

For more information on basic and advanced concepts of Σ - Δ ADCs, see the [MT-022 Tutorial](#) and [MT-023 Tutorial](#).

Digital filtering has certain advantages over analog filtering. Because digital filtering occurs after the analog-to-digital conversion process, it can remove noise injected during the conversion. Analog filtering cannot remove noise injected during conversion.

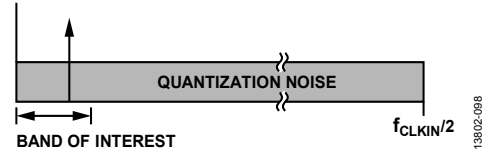

Figure 98. Σ - Δ ADC Operation, Reduction of Noise Energy Contained in the Band of Interest (Linear Scale X-Axis)

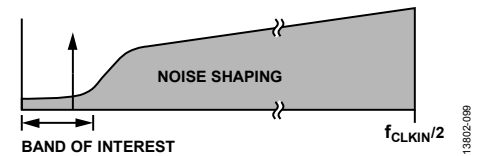

Figure 99. Σ - Δ ADC Operation, Majority of Noise Energy Shifted Out of the Band of Interest (Linear Scale X-Axis)

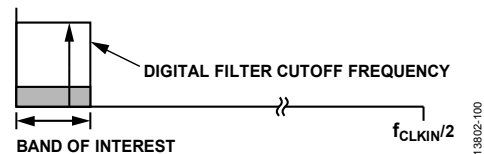

Figure 100. Σ - Δ ADC Operation, Removal of Noise Energy from the Band of Interest (Linear Scale X-Axis)

The Σ - Δ ADC starts the conversions of the input signal after the supplies generated by the internal LDO regulators become stable. An external signal is not required to generate the conversions.

ANALOG INPUTS

The AD7771 can be operated in bipolar or unipolar modes and accepts true differential, pseudo differential, and single-ended input signals, as shown in Figure 101 through Figure 104.

Table 10 summarizes the maximum differential input signal and dynamic range for the different input modes.

Table 10. Input Signal Modes

| Input Signal Mode | PGA Gain | Maximum Differential Signal | Maximum Peak-to-Peak Signal |
|---------------------|-----------|-----------------------------|-------------------------------|
| True differential | All gains | $\pm(V_{REF}/PGA_{GAIN})$ | $2 \times V_{REF}/PGA_{GAIN}$ |
| Pseudo differential | All gains | $\pm(V_{REF}/PGA_{GAIN})$ | $2 \times V_{REF}/PGA_{GAIN}$ |
| Single-ended | All gains | V_{REF}/PGA_{GAIN} | V_{REF}/PGA_{GAIN} |

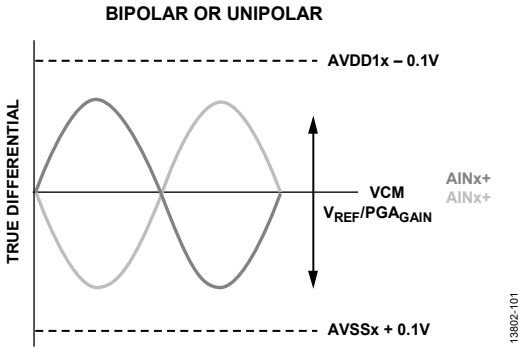

Figure 101. Σ - Δ ADC Input Signal Configuration, True Differential

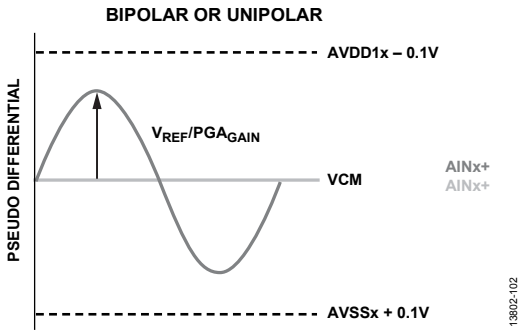

Figure 102. Σ - Δ ADC Input Signal Configuration, Pseudo Differential

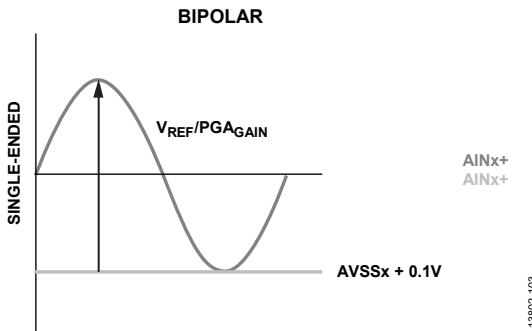

Figure 103. Σ - Δ ADC Input Signal Configuration, Single-Ended Bipolar

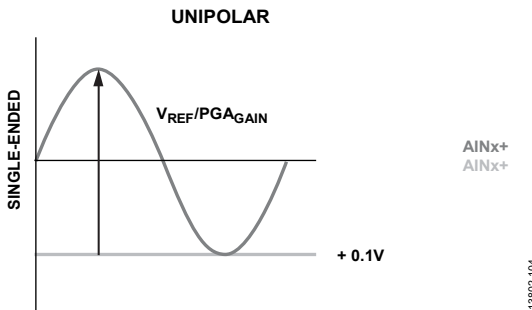

Figure 104. Σ - Δ ADC Input Signal Configuration, Single-Ended Unipolar

The common mode input signal is not limited, but keep the absolute input signal voltage on any $AINx\pm$ pin between $AVSSx + 100\text{ mV}$ and $AVDD1x - 100\text{ mV}$; otherwise, the input signal linearity degrades and, if the signal voltage exceeds the absolute maximum signal rating, damages the device.

Figure 105 shows the maximum and minimum voltage common-mode range at different PGA gains for a maximum differential input voltage.

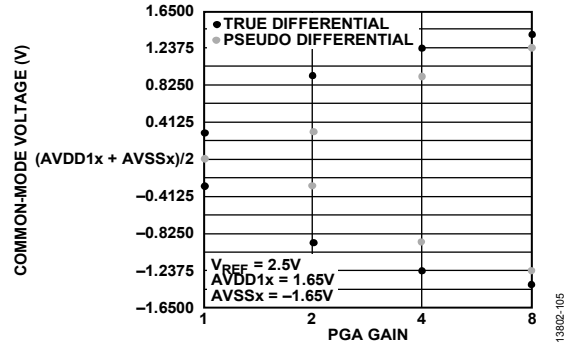

Figure 105. Maximum Common-Mode Voltage Range for a Maximum Differential Input Signal

The AD7771 provides a common-mode voltage pin ($AVDD1x + AVSSx/2$), VCM , for the single-supply, pseudo differential, or true differential input configurations.

TRANSFER FUNCTION

The AD7771 can operate with up to a 3.6 V reference, typical at 2.5 V, and converts the differential voltage between the analog inputs ($AINx+$ and $AINx-$) into a digital output. The ADC converts the voltage difference between the analog input pins ($AINx+ - AINx-$) into a digital code on the output. The 24-bit conversion result is in MSB first, twos complement format, as shown in Table 11 and Figure 106.

Table 11. Output Codes and Ideal Input Voltages for $PGA = 1\times$

| Condition | Analog Input (($AINx+$) - ($AINx-$)), $V_{REF} = 2.5\text{ V}$ | Digital Output Code, Twos Complement (Hexadecimal) |
|------------------|--|--|
| FS - 1 LSB | +2.499999702 V | 0x7FFFFF |
| Midscale + 1 LSB | +298 nV | 0x000001 |
| Midscale | 0 V | 0x000000 |
| Midscale - 1 LSB | -298 nV | 0xFFFFF |
| -FS + 1 LSB | -2.499999702 V | 0x800001 |
| -FS | -2.5 V | 0x800000 |

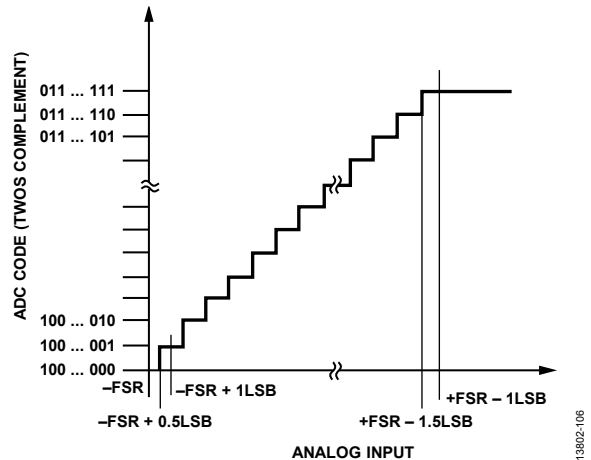

Figure 106. Transfer Function

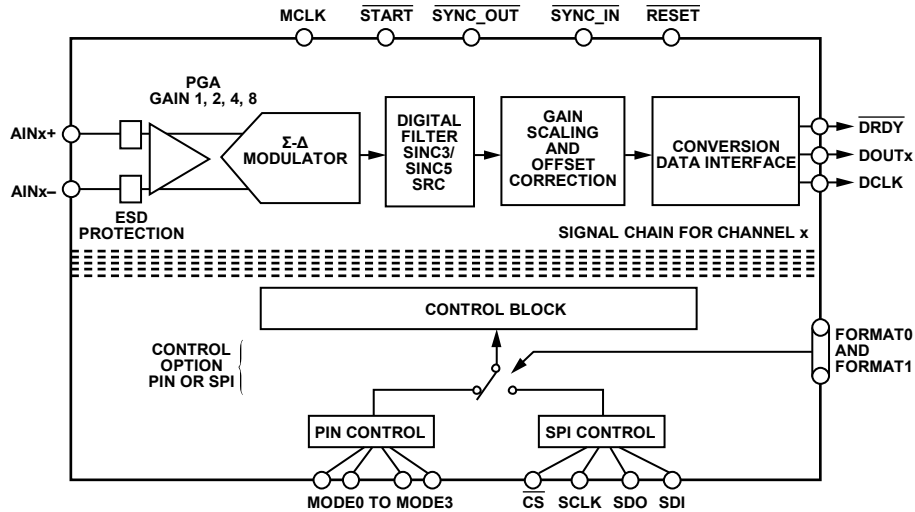

Figure 107. Top Level Core Signal Chain

CORE SIGNAL CHAIN

Each Σ - Δ ADC channel on the AD7771 has an identical signal path from the analog input pins to the digital output pins. Figure 107 shows a top level implementation of this signal chain. Prior to each Σ - Δ ADC, a PGA maps sensor outputs into the ADC inputs, providing low input current in dc (± 8 nA, input current, and ± 2 nA differential input current for high resolution mode), an 8 pF input capacitance in ac, and configurable gains of 1, 2, 4, and 8. See the [AN-1392 Application Note](#) for more information. Each ADC channel has its own Σ - Δ modulator, which oversamples the analog input and passes the digital representation to the digital filter block. The data is filtered, scaled for gain and offset, and is then output on the data interface.

To minimize power consumption, the channels can be individually disabled.

CAPACITIVE PGA

Each Σ - Δ ADC has a dedicated PGA, offering gain ranges of 1, 2, 4, and 8. This PGA reduces the need for an external input buffer and allows the user to amplify small sensor signals to use the full dynamic range of the AD7771.

The PGA maximizes the signal chain dynamic range for small sensor output signals.

The AD7771 uses chopping of the PGA to minimize offset and offset drift in the input amplifier, reducing the $1/f$ noise as well. For the AD7771, the chopping frequency is set to 128 kHz for high resolution mode, and 32 kHz for low power mode (see the [AN-1392 Application Note](#) for more information). The chopping tone is rejected by the sinc3 or sinc5 filters.

To minimize intermodulation effects that may cause an image in the band of interest, it is recommended to limit the input signal bandwidth to $2/3$ of the chop frequency.

The capacitive PGA common-mode voltage does not depend on the gain, and can be any value as long as the input signal voltage is within $AVSSx + 100$ mV to $AVDD1x - 100$ mV. See Figure 105

for the maximum common-mode voltage at maximum differential input signals.

INTERNAL REFERENCE AND REFERENCE BUFFERS

The AD7771 integrates a 2.5 V, ± 10 ppm/ $^{\circ}\text{C}$ (typical), voltage reference that is disabled at power-up. The buffered reference is available at Pin 49 and offers up to 10 mA of continuous current. A 100 nF capacitor is required if the reference is enabled.

In applications where a low noise reference is required, it is recommended to add a low-pass filter (LPF) with a cutoff frequency (f_{CUTOFF}) below 10 Hz to the REF_OUT pin. Connect the output of this filter to REFx+, and connect $AVSSx$ to REFx-. In this scenario, configure the Σ - Δ reference as external. An example of performance with and without the output filter is shown in Figure 108.

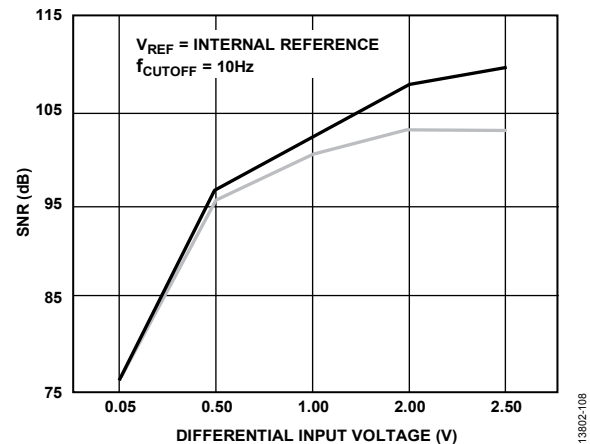
Figure 108. SNR Adding External LPF with V_{REF} = Internal Reference and $f_{\text{CUTOFF}} = 10$ Hz

The AD7771 can be used with an external reference connected between the REFx+ and REFx- pins. Recommended reference voltage sources for the AD7771 include the [ADR441](#) and [ADR4525](#) family of low noise, high accuracy voltage references.

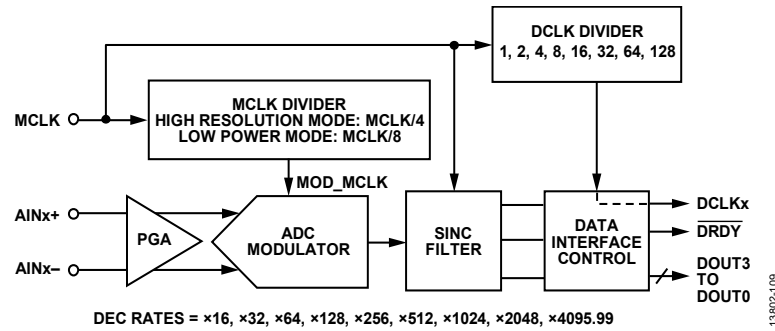

Figure 109. Clock Generation on the AD7771

The reference buffers can be operated in three different modes: buffer enabled mode, buffer bypassed mode, and buffer precharged mode.

In buffer enabled mode, the buffer is fully enabled, minimizing the current requirements from the external references. Note that the buffer output voltage headroom is ± 100 mV from the rails.

In buffer bypassed mode, the external reference is directly connected to the ADC reference capacitors; the reference must provide enough current to correctly charge the internal ADC reference capacitors. In this mode of operation, a degradation in crosstalk is expected because the ADC channels are not isolated from each other.

Buffer precharged (pre-Q) mode is the default operation mode. It is a hybrid mode where the internal reference buffers are connected during the initial acquisition time to precharge the internal ADC reference capacitors. During the final phase of the acquisition, the reference is connected directly to the ADC capacitors. This mode has some benefits compared to the buffer enabled and buffer bypassed modes. In buffer pre-Q mode, the reference current requirements are minimized compared to buffer bypassed mode and the noise contribution from the internal reference buffers is removed (compared to buffer enabled mode).

In buffer pre-Q mode, the headroom/footroom of the buffer reference is not applicable because the reference sets the final voltage in the ADC reference capacitors.

INTEGRATED LDOs

The AD7771 has three internal LDOs to regulate the internal supplies: two LDOs for the analog block and one LDO for the digital core. The internal LDOs requires an external $1 \mu\text{F}$ decoupling capacitor on the DREGCAP, AREG1CAP, and the AREG2CAP pins. The LDO slew rate may be low because it depends on the main supply slew rate; therefore, a hardware reset generated by pulsing the $\overline{\text{RESET}}$ pin at power-up is required to guarantee that the digital block initializes correctly.

CLOCKING AND SAMPLING

The AD7771 includes eight Σ - Δ ADC cores. Each ADC receives the same master clock signal. The AD7771 requires a maximum external MCLK frequency of 8192 kHz for high resolution mode and 4096 kHz for low power mode. The MCLK is internally divided by 4 in high performance mode and by 8 in low power mode to produce the modulator MCLK (MOD_MCLK) signal used as the modulator sampling clock for the ADCs. The MCLK can be decreased to accommodate lower ODRs if the minimum ODR selected by the sinc3 filter is not low enough. If the external clock is lower than 250 kHz, set the CLK_QUAL_DIS bit (in SPI control mode only).

The AD7771 integrates an internal oscillator clock that initializes the internal registers at power-up. The CLK_SEL pin defines the external clock used after initialization (see Table 12).

Table 12. Clock Sources

| CLK_SEL State | Clock Source | Connection |
|---------------|--------------|---|
| 0 | CMOS | Input to XTAL2/MCLK, IOVDD logic level. XTAL1 must be tied to DGND. |
| 1 | Crystal | Connected between XTAL1 and XTAL2/MCLK. |

The MCLK signal generates the DCLK output signal, which in turn clocks the Σ - Δ conversion data from the AD7771, as shown in Figure 109.

DIGITAL RESET AND SYNCHRONIZATION PINS

An external pulse in the SYNC_IN pin generates the internal reset of the digital block; this pulse does not affect the data programmed in the internal registers. A pulse in this pin is required in two cases as follows:

- After updating one or more registers directly related to the sinc filter (power mode, offset, gain, phase compensation, and sinc filter).
- To synchronize multiple devices.

The pulse in the $\overline{\text{SYNC_IN}}$ pin must be synchronous with MCLK.

There are two different ways to achieve a synchronous pulse if the controller/processor cannot generate it as follows:

- Applying an asynchronous pulse on the $\overline{\text{START}}$ pin, which is then internally synchronized with the external MCLK clock, and the resulting synchronous signal is output on the $\overline{\text{SYNC_OUT}}$ pin.
- Triggering the $\overline{\text{SYNC_OUT}}$ internally. When the AD7771 is configured in SPI control mode, toggling Bit 0 in the GENERAL_USER_CONFIG_2 register generates a synchronous pulse that is output on the $\overline{\text{SYNC_OUT}}$ pin.

The $\overline{\text{SYNC_IN}}$ and $\overline{\text{SYNC_OUT}}$ pins must be externally connected if internal synchronization is used.

If multiple AD7771 devices must be synchronized, the $\overline{\text{SYNC_OUT}}$ pin of one device can be connected to multiple devices. This synchronization method requires the use of a common MCLK signal for all the AD7771 devices connected, as shown in Figure 110.

If the $\overline{\text{START}}$ pin is not used, tie it to DGND.

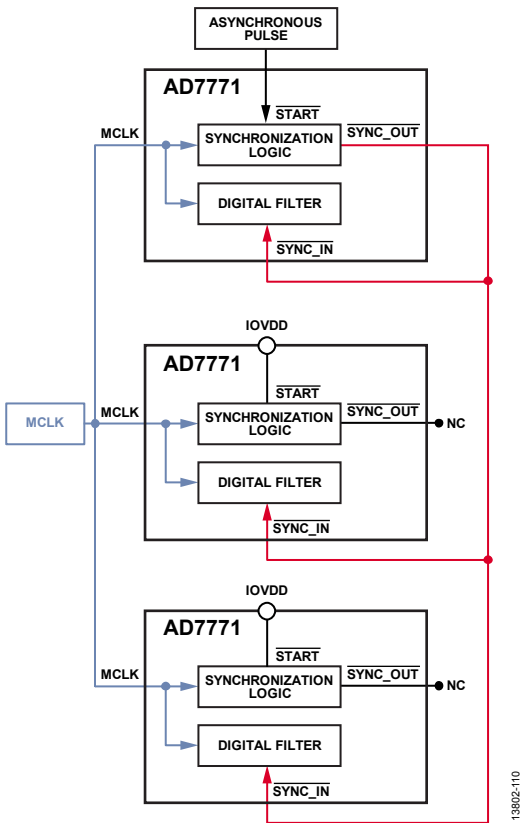

Figure 110. Multiple AD7771 Devices Synchronization

DIGITAL FILTERING

The AD7771 offers low latency sinc3 and sinc5 filters. Most precision Σ - Δ ADCs use sinc filters because the sinc filters offer a low latency path for applications requiring low bandwidth signals, for example, in control loops or where application specific postprocessing is required. The digital filter adds notches at multiples of the sampling frequency.

The digital sinc3 filter implements three main notches, one at the maximum ODR (128 kHz or 32 kHz, depending on the power mode) and another two at the ODR frequency selected to stop noise aliasing into the pass band. The sinc5 filter implements five notches, one at the maximum ODR (128 kHz or 32 kHz, depending on the power mode) and another four at the ODR frequency selected to stop noise aliasing into the pass band. It is recommended to select the sinc5 digital filter for output data rates higher than 24 kSPS.

Figure 111 and Figure 112 show the typical filter transfer function for the high resolution and low power modes using a decimation rate of 32 samples for the sinc3 and sinc5 filters.

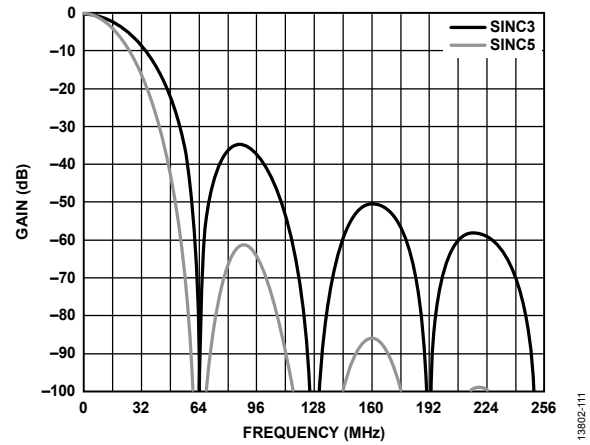

Figure 111. Sinc3/Sinc5 Frequency Response in High Resolution Mode

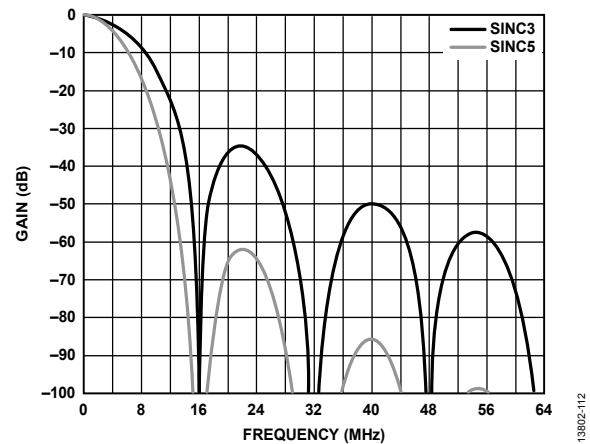

Figure 112. Sinc3/Sinc5 Frequency Response in Low Power Mode

The sample rate converter feature allows fine tuning of the decimation rate, even for noninteger multiples of the decimation rate. See the Sample Rate Converter (SRC) section for more information on filter profiles for noninteger decimation rates.

SHUTDOWN MODE

The AD7771 can be placed in shutdown mode by pulling AVDD2x to ground and connecting 1 M Ω resistance, pulled low, to XTAL2/MCLK. In this mode, the average current consumption is reduced to 1 mA, as shown in Figure 113.

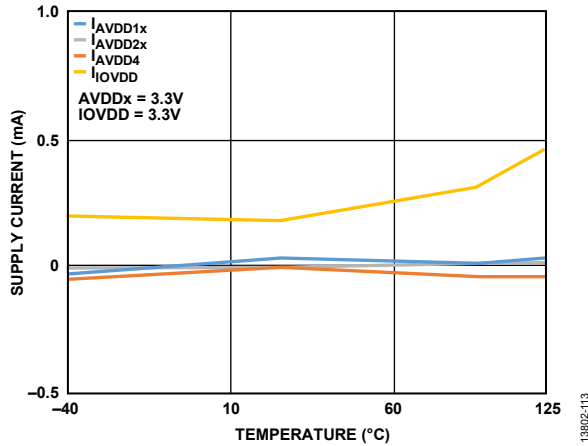

Figure 113. Shutdown Current

CONTROLLING THE AD7771

The AD7771 can be controlled using either pin control mode or SPI control mode.

Pin control mode allows the AD7771 to be hardwired to predefined settings that offer a subset of the overall functionality of the AD7771. In this mode, the SRC and diagnostic features or extended errors source are not available.

Controlling the AD7771 over the SPI allows the user access to the full monitoring, diagnostic, and Σ - Δ control functionality. SPI control offers additional functionality such as offset, gain, and phase correction per channel, in addition to access to the flexible SRC to achieve a coherent sampling.

See Table 13 for more details about these different configurations.

PIN CONTROL MODE

In pin control mode, the AD7771 is configured at power-up based on the level of the mode pins, MODE0, MODE1, MODE2, and MODE3. These four pins set the following functions on the AD7771: the mode of operation, the decimation rate/ODR, the PGA gain, and the reference source, as shown in Table 14.

Due to the limited number of mode pins and the number of options available, the PGA gain control is grouped into blocks of 4, and the ODR is selected for the maximum value defined by the decimation rate; $ODR \text{ (kHz)} = 2048/\text{decimation}$ for high resolution mode, and $ODR \text{ (kHz)} = 512/\text{decimation}$ for low power mode.

Depending on the mode selected, the device is configured to use an external or an internal reference.

The conversion data can be read back using the SPI or the data output interface, as shown in Table 13. If the data output interface is used to read back the data from the conversions, the number of DOUTx lines enabled and the number of clocks required for the Σ - Δ data transfer are determined by the logic level of the CONVST_SAR, FORMAT0, and FORMAT1 pins. In this case, the DCLK2, DCLK1, and DCLK0 pins select the Σ - Δ output interface and control the DCLKx divide function, which is a submultiple of MCLK, as shown in Table 15. The DCLKx divide function sets the frequency of the data output interface DCLKx signal. The DCLK minimum frequency depends on the decimation rate and operation mode. See the Data Output Interface section for more details about the minimum DCLKx frequency.

All the pins that define the AD7771 configuration mode are reevaluated each time the SYNC_IN pin is pulsed. The typical connection diagram for pin control mode is shown in Figure 114.

Table 13. Format of the Data Interface

| CONVST_SAR State | FORMAT1 | FORMAT0 | Control Mode | Data Output Mode |
|------------------|---------|---------|-------------------------------|--------------------------------|
| 1 | 0 | 0 | Pin | SPI output |
| | 0 | 1 | Pin | SPI output |
| | 1 | 1 | Pin | SPI output |
| | 1 | 1 | SPI | Defined in Register 0x014 |
| 0 | 0 | 0 | Pin | DOUT0, Channel 0 and Channel 1 |
| | | | | DOUT1, Channel 2 and Channel 3 |
| | 0 | 1 | Pin | DOUT2, Channel 4 and Channel 5 |
| | | | | DOUT3, Channel 6 and Channel 7 |
| 1 | 0 | Pin | DOUT0, Channel 0 to Channel 7 | |
| 1 | 1 | SPI | Defined in Register 0x014 | |

Table 14. Pin Control Mode Options

| Pin State | | | | Decimation Rate | Power Mode | PGA Gain Channel | | Reference Source | Filter |
|-----------|-------|-------|-------|-----------------|-----------------|------------------------|------------------------|------------------|--------|
| MODE3 | MODE2 | MODE1 | MODE0 | | | Channel 0 to Channel 3 | Channel 4 to Channel 7 | | |
| 0 | 0 | 0 | 0 | 16 | High resolution | 1 | 1 | External | Sinc5 |
| 0 | 0 | 0 | 1 | 16 | High resolution | 1 | 4 | External | Sinc5 |
| 0 | 0 | 1 | 0 | 32 | High resolution | 1 | 1 | External | Sinc5 |
| 0 | 0 | 1 | 1 | 32 | High resolution | 1 | 4 | External | Sinc5 |
| 0 | 1 | 0 | 0 | 64 | High resolution | 1 | 1 | External | Sinc5 |
| 0 | 1 | 0 | 1 | 64 | High resolution | 1 | 4 | External | Sinc5 |
| 0 | 1 | 1 | 0 | 128 | High resolution | 1 | 1 | External | Sinc5 |
| 0 | 1 | 1 | 1 | 128 | High resolution | 1 | 4 | External | Sinc5 |
| 1 | 0 | 0 | 0 | 256 | High resolution | 1 | 1 | External | Sinc5 |
| 1 | 0 | 0 | 1 | 16 | High resolution | 1 | 1 | Internal | Sinc5 |
| 1 | 0 | 1 | 0 | 32 | High resolution | 1 | 1 | Internal | Sinc5 |
| 1 | 0 | 1 | 1 | 64 | High resolution | 1 | 1 | Internal | Sinc5 |
| 1 | 1 | 0 | 0 | 16 | Low power | 1 | 1 | External | Sinc5 |
| 1 | 1 | 0 | 1 | 32 | Low power | 1 | 1 | External | Sinc5 |
| 1 | 1 | 1 | 0 | 64 | Low power | 1 | 1 | External | Sinc3 |
| 1 | 1 | 1 | 1 | 32 | Low power | 1 | 1 | External | Sinc3 |

Table 15. DCLKx Selection for Pin Control Mode State

| DCLK2/SCLK | DCLK1/SDI | DCLK0/SDO | MCLK Divider |
|------------|-----------|-----------|--------------|
| 0 | 0 | 0 | 1 |
| 0 | 0 | 1 | 2 |
| 0 | 1 | 0 | 4 |
| 0 | 1 | 1 | 8 |
| 1 | 0 | 0 | 16 |
| 1 | 0 | 1 | 32 |
| 1 | 1 | 0 | 64 |
| 1 | 1 | 1 | 128 |

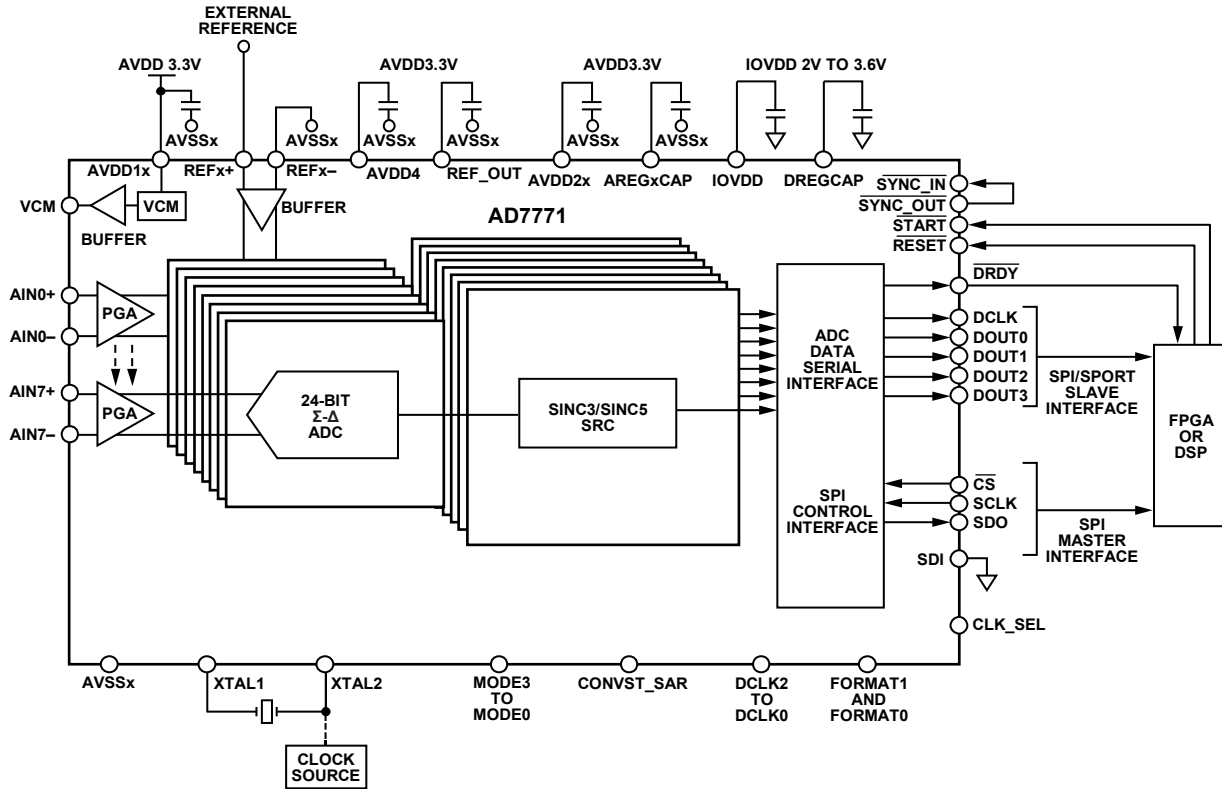

Figure 114. Pin Control Mode Connection Diagram with External Reference

13802-114

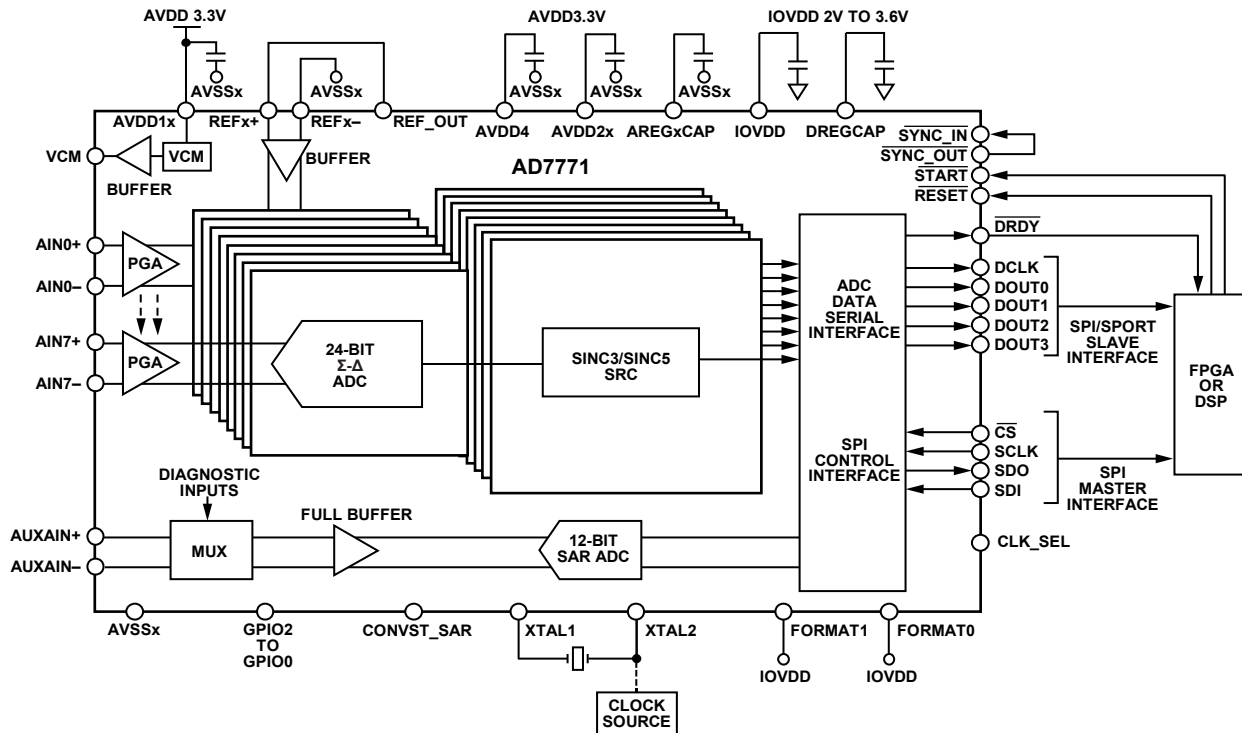

Figure 115. SPI Control Mode Connection Diagram with Internal Reference

13802-115

SPI CONTROL

The second option for control and monitoring the AD7771 is via the SPI. This option allows access to the full functionality on the AD7771, including access to the SAR converter, phase synchronization, offset and gain adjustment, diagnostics, and the SRC. To use the SPI control, set the FORMAT0 and FORMAT1 pins to logic high.

In this mode, the SPI can also read the Σ - Δ conversation data by setting the SPI_SLAVE_MODE_EN bit.

The typical connection diagram for SPI control mode is shown in Figure 115.

Functionality Available in SPI Control Mode

SPI control of the AD7771 offers the super set of the functions and diagnostics. The SPI Control Functionality section describes the functionality and diagnostics offered when in SPI control mode.

Offset and Gain Correction

Offset and gain registers are available for system calibration. The gain register is preprogrammed during final production for a PGA gain of 1, but can be overwritten with a new value if required.

The gain register is 24 bits long and is split across three registers, CHx_GAIN_UPPER_BYTE, CHx_GAIN_MID_BYTE, and CHx_GAIN_LOWER_BYTE, which set the gain on a per channel basis.

The gain value is relative to 0x555555, which represents a gain of 1.

The offset register is 24 bits long and is spread across three byte registers, CHx_OFFSET_UPPER_BYTE, CHx_OFFSET_MID_BYTE, and CHx_OFFSET_LOWER_BYTE. The default value is 0x000000 at power-up. Program the offset as a twos complement, signed 24-bit number. If the channel gain is set to its nominal value of 0x555555, an LSB of offset register adjustment changes the digital output by $-4/3$ LSBs.

As an example of calibration, the offset measured is -200 LSB (with both AINx \pm pins connected to the same potential).

An offset adjustment of -150 LSB changes the digital output by $-150 \times (-4/3) = 200$ LSBs (gain value = 0x555555), representing this number as two complement, 0xFFFFF - 0x96 + 1 = 0xFFFF70. Program the offset register as follows:

- CHx_OFFSET_UPPER_BYTE = 0xFF
- CHx_OFFSET_MID_BYTE = 0xFF
- CHx_OFFSET_LOWER_BYTE = 0x70

Note that the offset compensation is performed before the gain compensation. The gain is programmed during final testing for $PGA_{GAIN} = 1$. The gain register values can be overwritten; however, after a reset or power cycle, the gain register values revert to the hard coded programmed factory setting.

If the gain required is 0.75 of the nominal value (0x555555), the value that must be programmed is

$$0x555555 \times 0.75 = 0x400000$$

Then, an LSB of the offset register adjustment changes the digital output by $-4/3 \times 0.75 = 1$ LSB. Program the gain register as follows:

- CHx_GAIN_UPPER_BYTE = 0x40
- CHx_GAIN_MID_BYTE = 0x00
- CHx_GAIN_LOWER_BYTE = 0x00

SPI Control Functionality

Global Control Functions

The following list details the global control functions of the AD7771:

- High resolution and low power modes of operation
- ODR: SRC
- Sinc3 and sinc5 filters
- VCM buffer power-down
- Internal/external reference selection
- Enable, pre-Q, or bypassed reference buffer modes
- Internal reference power-down
- SAR diagnostic mux
- SAR power-down
- GPIO write/read
- SPI SAR conversion readback
- SPI slave mode—read Σ - Δ results
- SDO and DOUTx drive strength
- DOUTx mode
- DCLK division
- Internal LDO bypassed
- Cyclic redundancy check (CRC) protection: enabled or disabled

Per Channel Functions

The following list details the per channel functions of the AD7771:

- PGA gain.
- Σ - Δ channel power-down.
- Phase delay: synchronization phase offset per channel.
- Calibration of offset.
- Calibration of gain.
- Σ - Δ input signal mux.
- Channel error register.
- PGA gain.

Phase Adjustment

The AD7771 phase delay can be adjusted to compensate for phase mismatches between channels due to sensors or signal channel phase errors connected to the AD7771. Achieve phase adjustment by programming the CHx_SYNC_OFFSET register. This programming delays the synchronization signal by a certain number of modulator clocks (MOD_MCLK) to individually initiate the digital filter for each Σ - Δ ADC.

The phase adjustment register is read during the pulse; consequently, any further changes on the register have no effect unless a pulse is generated (see the Digital Reset and Synchronization

Pins section for more information on how to generate a pulse in the pin).

The phase offset register is multiplied internally by a factor that depends on the decimation rate, as shown in Table 16.

Table 16. Phase Adjustment vs. Decimation Rate

| Phase Adjustment Compensation | Decimation Rate |
|-------------------------------|-----------------|
| ×1 | ≤255 |
| ×2 | ≤511 |
| ×4 | ≤1023 |
| ×8 | ≤2047 |
| ×16 | ≤4095 |

The maximum phase delay cannot be equal to or greater than the decimation rate. If this is the case, the value changes internally to the decimation rate value minus 1.

As an example, the phase mismatch between Channel 0 and Channel 1 is 5°, and the ODR is 5 kSPS in high resolution mode. In this case, the decimation rate is 2048 kHz/5 kHz = 409.6, which means that the offset register value is multiplied internally by 2.

Assuming an input signal of 50 Hz, the number of MOD_MCLK pulses required to sample a full period is 2048 kHz/50 Hz = 40960 > 360°/40960 = 0.00878°.

If a 5° delay is required, the number of MOD_MCLK delays must be 569 (5°/0.00878°) because the offset register is multiplied by 2; the final offset register value is 409.6/2 – 569/2, which gives a negative value. In this case, if the offset value programmed to the register is higher than 204 (for example, 210 × 2 = 420), the value is internally changed to 408, resulting in a phase compensation of 408 × 0.00878° = 3.58°.

PGA Gain

The PGA gain can be selected individually by appropriately selecting Bits[7:6] in the CHx_CONFIG register, as shown in Table 17.

Table 17. PGA Gain Settings via CHx_CONFIG

| CHx_CONFIG, Bits[7:6] Setting | PGA Gain Setting |
|-------------------------------|------------------|
| 00 | ×1 |
| 01 | ×2 |
| 10 | ×4 |
| 11 | ×8 |

If the Σ-Δ reference is updated, it is recommended to apply a pulse on the SYNC_IN pin to remove invalid samples during the transition of the reference.

Decimation

The decimation defines the sampling frequency as follows:

- In high resolution mode, the sampling frequency = MCLK/ (4 × decimation)
- In low power mode, the sampling frequency = MCLK/ (8 × decimation)

Refer to the Sample Rate Converter (SRC) section for more information.

GPIOx Pins

If the AD7771 operates in SPI control mode, the mode pins operate as GPIOx pins, as shown in Figure 116. The GPIOx pins can be configured as inputs or outputs in any order.

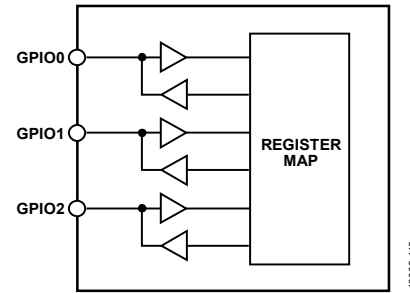

Figure 116. GPIOx Pin Functionality

Configuration control and readback of the GPIOx pins are set via Bits[2:0] in the GPIO_CONFIG register (0 = input, 1 = output) and the GPIO_DATA register. Among other uses, the GPIOs can control an external mux connected to the auxiliary inputs of the SAR ADC. Use this mux to verify the results on the Σ-Δ ADCs.

In addition, the GPIOx pins can be used to externally trigger a new decimation rate. Refer to the Sample Rate Converter (SRC) section for more information about this functionality.

Σ-Δ Reference Configuration

The AD7771 can operate with internal or external references. In addition, for diagnostic purposes, the analog supply can be used as a reference, as shown in Table 18. REFx-/REFx+ allow the selection of a voltage reference where the REFx+ voltage is lower than the voltage on the REFx- pin.

Table 18. Σ-Δ References

| Setting for ADC_MUX_CONFIG, Bits[7:6] | Channel 0 to Channel 3 | Channel 4 to Channel 7 |
|---------------------------------------|------------------------|------------------------|
| 00 | REF1+/REF1- | REF2+/REF2- |
| 01 | Internal reference | Internal reference |
| 10 | AVDD1A/AVSS1A | AVDD1B/AVSS1B |
| 11 | REF1-/REF1+ | REF2-/REF2+ |

Reference buffer operation is described in Table 19. The selected reference and buffer operation mode affect all channels.

If the Σ-Δ reference is updated, it is recommended to apply a pulse on the SYNC_IN pin to remove invalid samples during the transition of the reference.

Table 19. Reference Buffer Operation Modes

| Reference Buffer Operation Mode | REFx+ | REFx– |
|---------------------------------|--|--|
| Enabled | BUFFER_CONFIG_1, Bit 4 = 1; BUFFER_CONFIG_2, Bit 7 = 0 | BUFFER_CONFIG_1, Bit 3 = 1; BUFFER_CONFIG_2, Bit 6 = 0 |
| Precharged | BUFFER_CONFIG_1, Bit 4 = 1; BUFFER_CONFIG_2, Bit 7 = 1 | BUFFER_CONFIG_1, Bit 3 = 1; BUFFER_CONFIG_2, Bit 6 = 1 |
| Disabled | BUFFER_CONFIG_1, Bit 4 = 0 | BUFFER_CONFIG_1, Bit 3 = 0 |

Table 20. Additional Disable Power-Down Blocks

| Block | Register | Notes |
|-----------------------------|------------------------------|---------------------------|
| VCM | GENERAL_USER_CONFIG_1, Bit 5 | Enabled by default |
| Reference Buffer | BUFFER_CONFIG_1, Bits[4:3] | Precharge mode by default |
| Internal Reference Buffer | GENERAL_USER_CONFIG_1, Bit 4 | Disabled by default |
| Σ - Δ Channel | CH_DISABLE, Bits[7:0] | All channels enabled |
| SAR | GENERAL_USER_CONFIG_1, Bit 3 | Disabled by default |
| Internal Oscillator | GENERAL_USER_CONFIG_1, Bit 2 | Enabled by default |

Power Modes

The AD7771 offers different power modes to improve the power efficiency, high resolution and low power mode, which can be controlled via GENERAL_USER_CONFIG_1, Bit 6. To further reduce the power, additional blocks can be disabled independently, as described in Table 20.

If the power mode changes, a pulse on the SYNC_IN pin is required.

Sinc3 and Sinc5 Filters

The AD7771 implements sinc3 and sinc5 digital filters. By default, the device powers up with the sinc3 filter, but it can be changed by setting GENERAL_USER_CONFIG_2, Bit 6. If the sinc filter is changed, a pulse in the SYNC_IN pin is required.

LDO Bypassing

The internal LDOs can be individually bypassed and an external supply can be applied directly to the AREG1CAP, AREG2CAP, or DREGCAP pin. Table 21 shows the absolute minimum and maximum supplies for these pins, as well as the associated register used to bypass the regulator.

Table 21. LDO Bypassing

| LDO | BUFFER_CONFIG_2, Bits[2:0] ¹ | Supply | |
|----------|---|---------|---------|
| | | Max (V) | Min (V) |
| AREG1CAP | 1XX | 1.9 | 1.85 |
| AREG2CAP | X1X | 1.9 | 1.85 |
| DREGCAP | XX1 | 1.9 | 1.65 |

¹ X means don't care.

DIGITAL SPI

The SPI serial interface on the AD7771 consists of four signals: CS, SDI, SCLK, and SDO. A typical connection diagram of the SPI is shown in Figure 117.

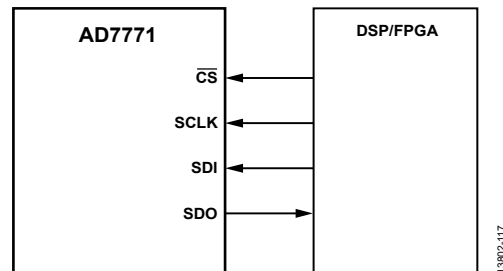

Figure 117. SPI Control Interface—AD7771 is the SPI Slave, Digital Signal Processor (DSP)/Field Programmable Gate Array (FPGA) is the Master

The SPIs operates in Mode 0 and Mode 3, CPOL = 0, CPHA = 0 (Mode 0) or CPOL = 1, CPHA = 1 (Mode 3).

In pin control mode, the SDI can read back the Σ - Δ results, depending on the level of the CONVST_SAR pin, as described in Table 13.

In SPI control mode, the SPI transfers data into the on-chip registers while the SDO pin reads back data from the on-chip registers or reads the SAR or the Σ - Δ conversions results, depending on the selected operation mode.

The SDO data source in SPI control mode is defined by the GENERAL_USER_CONFIG_2 and GENERAL_USER_CONFIG_3 registers, as described in Table 22.

Table 22. SPI Operation Mode in SPI Control Mode

| GENERAL_USER_CONFIG_2, Bit 5 Setting | GENERAL_USER_CONFIG_3, Bit 4 Setting ¹ | Mode |
|--------------------------------------|---|-------------------------------------|
| 0 | 0 | Internal register |
| 0 | 1 | Σ - Δ data conversion |
| 1 | X | SAR conversion |

¹ X means don't care.

In SPI control mode, there are four different levels of input/output (I/O) strength on the SDO pin that can be selected in GENERAL_USER_CONFIG_2, Bits[4:3], as described in Table 23.

Table 23. SDO Strength

| GENERAL_USER_CONFIG_2, Bits[4:3] Setting | Mode |
|--|--------------|
| 00 | Nominal |
| 01 | Strong |
| 10 | Weak |
| 11 | Extra strong |

SCLK is the serial clock input for the device. All data transfers (on either SDO or SDI) occur with respect to this SCLK signal.

The SPI can operate in multiples of eight bits. For example, in SPI control mode, if the SDO pin is used to read back the data from the internal register or the SAR ADC, the data frame is 16 bits wide (CRC disabled), as shown in Figure 118, or 24 bits wide (CRC enabled), as shown in Figure 119. In this case, the controller can generate one frame of 16 bits or 24 bits (with and without the CRC enabled), or two or three frames of 8 bits (with and without the CRC enabled). When the SDO pin reads back the data from the Σ - Δ channels, 64 bits must be read back from the controller (in this case, the controller can generate a frame of 64 bits—either 2 \times 32 bits, 4 \times 16 bits, or 8 \times 8 bits).

SPI CRC—Checksum Protection (SPI Control Mode)

The AD7771 has a checksum mode that improves SPI robustness in SPI control mode. Using the checksum ensures that only valid data is written to a register and allows data read from the device to be validated. The SPI CRC can be enabled by setting the SPI_CRC_TEST_EN bit. If an error occurs during a register write, the SPI_CRC_ERR is set in the error register.

Enabling the SPI_CRC_TEST_EN bit results in a CRC checksum being performed on all the R/W operations. When SPI_CRC_TEST_EN is enabled, an 8-bit CRC word is appended to every SPI transaction for SAR and register map operations. For more information on Σ - Δ readback operations, see the CRC Header section.

To ensure that the register write is successful, it is recommended to read back the register and verify the checksum.

For CRC checksum calculations, the following polynomial is always used: $x^8 + x^2 + x + 1$. See the SPI Control Mode Checksum section for more information.

SPI Read/Write Register Mode (SPI Control Mode)

The AD7771 has on-board registers to configure and control the device.

The registers have 7-bit addresses—the 7-bit register address on the SDI line selects the register for the read/write function. The 7-bit register address follows the R/W bit in the SDI data. The 8 bits on the SDI line following the 7-bit register address are the data to be written to the selected register if the SPI is a write transfer. Data on the SDI line is clocked into the AD7771 on the rising edge of SCLK, as shown in Figure 3.

The data on the SDO line during the SPI transfer contains the 8-bit 0010 0000 header: 8 bits of register data in the case of a read (R) operation, or 8 zeros in the case of a write (W) operation.

With the CRC disabled, the basic data frame on the SDI line during the transfer is 16 bits long, as shown in Figure 118. When the CRC is enabled, a minimum frame length of 24 SCLK periods are required on SPI transfers. The 24 bits of data on the SDO line consist of an 8-bit header (0010 0000), 8 bits of data, and an 8-bit CRC (see Figure 119).

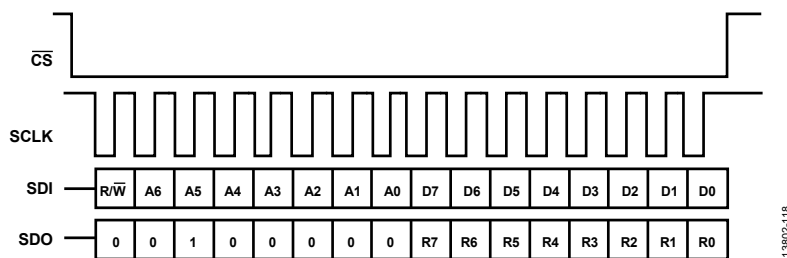

Figure 118. 16-Bit SPI Transfer—CRC Disabled

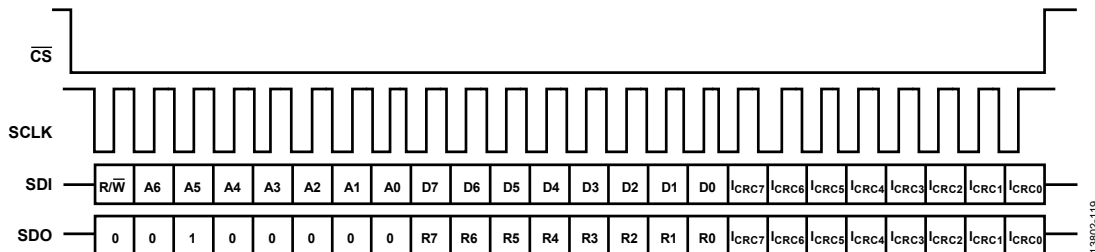

Figure 119. 24-Bit SPI Transfer—CRC Enabled

SPI SAR Diagnostic Mode (SPI Control Mode)

Setting Bit 5 in the GENERAL_USER_CONFIG_2 register configures the SDO line to shift out data from the SAR ADC conversions, as described in Table 22.

In SAR mode, the AD7771 internal registers can be written to, but any readback command is ignored because the SDO data frame is dedicated to shift out the conversion results from the SAR ADC.

To exit this mode of operation, reset Bit 5 in the GENERAL_USER_CONFIG_2 register.

The data on the SDO line during the SPI transfer contains a 4-bit 0010 header and the 12-bit SAR conversion result if the CRC is disabled.

When the CRC is enabled, a minimum frame length of 24 SCLK periods is required on SPI transfers. The 24 bits of data on the SDO line consist of a 4-bit header (0010), the 12-bit data, and an 8-bit CRC, as shown in Figure 120.

Per the SPI read/write register mode (see the SPI Read/Write Register Mode section), the SDI line contains the R/W bit, a 7-bit register address, the 8-bit data, and an 8-bit CRC (if enabled). To avoid unwanted writes to the internal register while the SAR conversions are read back through the SDO line, it is recommended to send a readback command, for example, 0x8000,

to the device, which is ignored because the SDO pin shifts out the content of the SAR ADC.

If consecutive conversions are performed in the SAR ADC, read back the result from the previous conversion before a new conversion is generated. Otherwise, the results are corrupted.

Σ - Δ Data, ADC Mode

In pin control mode, the SPI can be used to read back the Σ - Δ conversions as described in Table 13. In SPI control mode, the SPI reads back the Σ - Δ conversions by setting GENERAL_USER_CONFIG_3, Bit 4, as described in Table 22; in this mode, the AD7771 internal register can be written to, but any readback command is ignored because the SDO data frame is dedicated to shifting out the conversion results from the Σ - Δ ADCs. To avoid unwanted writes to the internal register, it is recommended to send a readback command, for example, 0x8000, to the device, which is ignored because the SDO pin shifts out the content of the Σ - Δ ADC.

The SDO pin data can be read back in any multiple of 8 bits, for example, as 64 bits, 2 \times 32 bits, 4 \times 16 bits, or 8 \times 8 bits.

SPI Software Reset

Keeping the SDI pin high during 64 consecutive clocks generates a software reset.

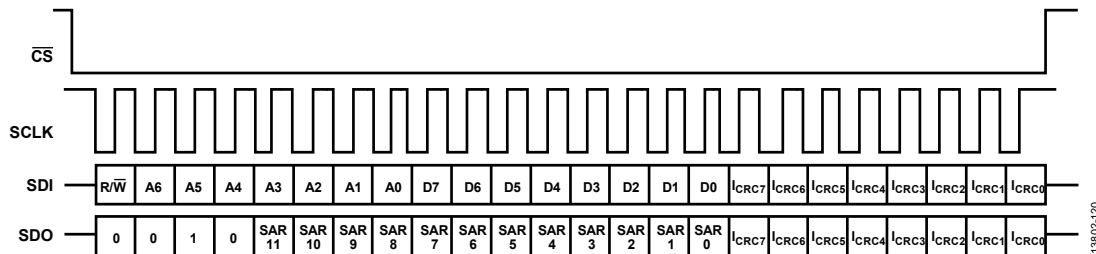

Figure 120. SAR ADC/Diagnostic Mode—CRC Enabled

RMS NOISE AND RESOLUTION

Table 24 through Table 27 show the dynamic range (DR), rms noise (RTI), effective number of bits (ENOB), and effective resolution (ER) of the AD7771 for various output data rates and gain settings. The numbers given are for the bipolar input range with an external 2.5 V reference. These numbers are typical and are generated with a differential input voltage of 0 V when the ADC is continuously converting on a single channel.

It is important to note that the effective resolution is calculated using the rms noise; 16,384 consecutive samples were used to calculate the rms noise.

$$\text{Effective Resolution} = \log_2(\text{Input Range}/\text{RMS Noise})$$

$$\text{ENOB} = (\text{DR} - 1.78)/6$$

HIGH RESOLUTION MODE

Table 24. DR and RTI for High Resolution Mode

| Sinc Filter | Decimation Rate | Output Data Rate (SPS) | f _{-3 dB} (Hz) | Gain = 1 | | Gain = 2 | | Gain = 4 | | Gain = 8 | |
|-------------|-----------------|------------------------|-------------------------|----------|--------------|----------|--------------|----------|--------------|----------|--------------|
| | | | | DR (dB) | RTI (μV rms) | DR (dB) | RTI (μV rms) | DR (dB) | RTI (μV rms) | DR (dB) | RTI (μV rms) |
| Sinc5 | 16 | 128,000 | 26542.34 | 95.1 | 31.32 | 91.7 | 22.68 | 87.1 | 19.39 | 82.0 | 17.11 |
| | 32 | 64,000 | 13403.14 | 101.8 | 14.31 | 98.5 | 10.30 | 94.4 | 8.41 | 89.7 | 7.37 |
| | 64 | 32,000 | 6833.54 | 107.1 | 7.90 | 105.3 | 4.85 | 101.5 | 3.65 | 96.9 | 3.14 |
| | 256 | 8,000 | 1906.34 | 114.4 | 3.34 | 113.8 | 1.84 | 111.6 | 1.16 | 107.9 | 0.91 |
| Sinc3 | 128 | 16,000 | 4878.83 | 105.7 | 9.01 | 105.2 | 4.88 | 103.2 | 2.99 | 99.6 | 2.26 |
| | 256 | 8,000 | 2756.43 | 112.1 | 4.32 | 111.5 | 2.31 | 109.3 | 1.52 | 105.5 | 1.19 |
| | 512 | 4,000 | 1695.23 | 115.8 | 2.86 | 115.6 | 1.51 | 113.5 | 0.96 | 109.5 | 0.75 |
| | 1024 | 1,000 | 899.33 | 122.0 | 1.39 | 121.6 | 0.73 | 119.6 | 0.47 | 115.7 | 0.36 |

Table 25. ENOB and ER for High Resolution Mode

| Sinc Filter | Decimation Rate | Output Data Rate (SPS) | f _{-3 dB} (Hz) | Gain = 1 | | Gain = 2 | | Gain = 4 | | Gain = 8 | |
|-------------|-----------------|------------------------|-------------------------|-------------|-----------|-------------|-----------|-------------|-----------|-------------|-----------|
| | | | | ENOB (Bits) | ER (Bits) | ENOB (Bits) | ER (Bits) | ENOB (Bits) | ER (Bits) | ENOB (Bits) | ER (Bits) |
| Sinc5 | 16 | 128,000 | 26542.34 | 15.5 | 17.3 | 14.9 | 17.8 | 14.2 | 18.0 | 13.3 | 18.2 |
| | 32 | 64,000 | 13403.14 | 16.6 | 18.4 | 16.1 | 18.9 | 15.4 | 19.2 | 14.6 | 19.4 |
| | 64 | 32,000 | 6833.54 | 17.5 | 19.3 | 17.2 | 20.0 | 16.6 | 20.4 | 15.8 | 20.6 |
| | 256 | 8,000 | 1906.34 | 18.7 | 20.5 | 18.6 | 21.4 | 18.2 | 22.0 | 17.6 | 22.4 |
| Sinc3 | 128 | 16,000 | 4878.83 | 17.3 | 19.1 | 17.2 | 20.0 | 16.9 | 20.7 | 16.3 | 21.1 |
| | 256 | 8,000 | 2756.43 | 18.3 | 20.1 | 18.2 | 21.0 | 17.9 | 21.6 | 17.2 | 22.0 |
| | 512 | 4,000 | 1695.23 | 18.9 | 20.7 | 18.9 | 21.7 | 18.6 | 22.3 | 17.9 | 22.7 |
| | 1024 | 1,000 | 899.33 | 20.0 | 21.8 | 19.9 | 22.7 | 19.6 | 23.3 | 18.9 | 23.7 |

LOW POWER MODE

Table 26. DR and RTI for Low Power Mode

| Sinc Filter | Decimation Rate | Output Data Rate (SPS) | f _{-3 dB} (Hz) | Gain = 1 | | Gain = 2 | | Gain = 4 | | Gain = 8 | |
|-------------|-----------------|------------------------|-------------------------|----------|--------------|----------|--------------|----------|--------------|----------|--------------|
| | | | | DR (dB) | RTI (μV rms) | DR (dB) | RTI (μV rms) | DR (dB) | RTI (μV rms) | DR (dB) | RTI (μV rms) |
| Sinc5 | 16 | 32,000 | 6833.54 | 94.3 | 34.2 | 90.9 | 25.04 | 86.5 | 20.5 | 81.3 | 19.43 |
| | 32 | 16,000 | 3548.74 | 100.9 | 15.7 | 97.8 | 11.22 | 93.6 | 9.0 | 87.9 | 8.39 |
| | 64 | 8,000 | 1906.34 | 106.7 | 83.3 | 104.6 | 5.18 | 100.6 | 4.03 | 96.1 | 3.46 |
| | 512 | 1,000 | 469.24 | 117.1 | 25.2 | 116.8 | 1.29 | 114.4 | 8.41 | 110.7 | 0.67 |
| Sinc3 | 64 | 8,000 | 2756.43 | 95.5 | 29.86 | 95.0 | 15.26 | 93.7 | 8.9 | 90.8 | 6.11 |
| | 128 | 4,000 | 1695.23 | 105.4 | 9.47 | 105.1 | 4.95 | 102.7 | 3.21 | 98.7 | 2.51 |
| | 256 | 2,000 | 1164.63 | 111.7 | 4.62 | 111.2 | 2.41 | 108.9 | 1.57 | 104.8 | 1.27 |
| | 1024 | 500 | 766.68 | 118.6 | 2.1 | 118.2 | 1.07 | 116.2 | 0.7 | 112.5 | 0.54 |

Table 27. ENOB and ER for Low Power Mode

| Sinc Filter | Decimation Rate | Output Data Rate (SPS) | f _{-3 dB} (Hz) | Gain = 1 | | Gain = 2 | | Gain = 4 | | Gain = 8 | |
|-------------|-----------------|------------------------|-------------------------|-------------|-----------|-------------|-----------|-------------|-----------|-------------|-----------|
| | | | | ENOB (Bits) | ER (Bits) | ENOB (Bits) | ER (Bits) | ENOB (Bits) | ER (Bits) | ENOB (Bits) | ER (Bits) |
| Sinc5 | 16 | 32,000 | 6833.54 | 15.4 | 17.2 | 14.8 | 17.6 | 14.1 | 17.9 | 13.2 | 18.0 |
| | 32 | 16,000 | 3548.74 | 16.5 | 18.3 | 16.0 | 18.8 | 15.3 | 19.1 | 14.3 | 19.2 |
| | 64 | 8000 | 1906.34 | 17.4 | 15.9 | 17.1 | 19.9 | 16.4 | 20.2 | 15.7 | 20.5 |
| | 512 | 1000 | 469.24 | 19.2 | 17.6 | 19.1 | 21.9 | 18.7 | 19.2 | 18.1 | 22.8 |
| Sinc3 | 64 | 8,000 | 2756.43 | 15.6 | 17.4 | 15.5 | 18.3 | 15.3 | 19.1 | 14.8 | 19.6 |
| | 128 | 4,000 | 1695.23 | 17.2 | 19.0 | 17.2 | 19.9 | 16.8 | 20.6 | 16.1 | 20.9 |
| | 256 | 2,000 | 1164.63 | 18.3 | 20.0 | 18.2 | 21.0 | 17.8 | 21.6 | 17.1 | 21.9 |
| | 1024 | 500 | 766.68 | 19.4 | 21.2 | 19.3 | 22.2 | 19.0 | 22.8 | 18.4 | 23.1 |

DIAGNOSTICS AND MONITORING

SELF DIAGNOSTICS ERROR

The AD7771 includes self diagnostic features to guarantee the correct operation. If an error is detected, the ALERT pin (Pin 18 when using pin control mode or Pin 16 when using SPI control mode) is pulled high to generate an external interruption to the controller. In addition, the header of the Σ - Δ output data contains an alert bit that informs the controller of a chip error (see the ADC Conversion Output—Header and Data section).

Both the ALERT pin and bit (status header) are automatically cleared if the error is no longer present. The errors related to the SPI do not recover automatically; read back the appropriate register to clear the error. The ALERT pin and bit reset in the next SPI access after the bit is read back.

If an error detector is manually disabled, it does not generate an internal error and, consequently, the register map or the ALERT pin and bit are not triggered.

There are different sources of errors, as described in Table 28. In pin control code, it is not possible to check the error source, and some sources of error are not enabled. In SPI control mode, check the source of an error by reading the appropriate register bit.

The STATUS_REG_x register bits identify the register that generates an error, as summarized in Table 28.

Table 28. Register Error Source

| Bit Name | Register Source |
|-------------------|-----------------|
| ERR_LOC_GEN2 | GEN_ERR_REG_2 |
| ERR_LOC_GEN1 | GEN_ERR_REG_1 |
| ERR_LOC_CH7 | CH7_ERR_REG |
| ERR_LOC_CH6 | CH6_ERR_REG |
| ERR_LOC_CH5 | CH5_ERR_REG |
| ERR_LOC_CH4 | CH4_ERR_REG |
| ERR_LOC_CH3 | CH3_ERR_REG |
| ERR_LOC_CH2 | CH2_ERR_REG |
| ERR_LOC_CH1 | CH1_ERR_REG |
| ERR_LOC_CH0 | CH0_ERR_REG |
| ERR_LOC_SAT_CH6_7 | CH6_7_SAT_ERR |
| ERR_LOC_SAT_CH4_5 | CH4_5_SAT_ERR |
| ERR_LOC_SAT_CH2_3 | CH2_3_SAT_ERR |
| ERR_LOC_SAT_CH0_1 | CH0_1_SAT_ERR |

In addition, the STATUS_REG_x registers have a bit that indicates if any internal error bit is set, CHIP_ERROR. This bit clears if the error is no longer present and the register is read back.

The INIT_COMPLETE bit in the STATUS_REG_3 indicates that the device is initialized correctly. This bit is not an error bit but an indicator.

General Errors

MCLK Switch Error (SPI Control Mode)

After power-up, the AD7771 initiates a clocking handover sequence to pass clocking control to the external oscillator, or

the CMOS clock. In SPI control mode, if an error occurs in the handover, the EXT_MCLK_SWITCH_ERR bit is set in the general error register, GEN_ERR_REG_2.

If EXT_MCLK_SWITCH_ERR is set, this means that the device is operating using the internal oscillator.

To use a slow external clock (<265 kHz), set the CLK_QUAL_DIS bit. Setting this bit also clears the error bit.

If the external clock is between 132 kHz and 265 kHz, depending on the internal synchronization between the internal oscillator and the external clock, the error may not trigger. However, it is still recommended to set the CLK_QUAL_DIS bit.

If a slow clock is not in use and the error triggers, a reset is required.

Reset Detection

The AD7771 general error register contains a RESET_DETECTED bit. This bit is asserted if a reset pulse is applied to the AD7771 and is cleared by reading the general error register. This bit indicates that the power-on reset (POR) initialized correctly on the device. In addition, this bit can be used to detect an unexpected device reset or glitch on the RESET pin. To reset this error signal in SPI control mode, toggle the SYNC_IN pin or read from the general error register, GEN_ERR_REG_2. To reset this error signal in pin control mode, toggle the SYNC_IN pin.

Internal LDO Status

The AD7771 has three internal LDOs to regulate the internal analog and digital supply rails. The LDOs have internal power supply monitors. Internal comparators monitor and flag errors with these supplies after they pass a predetermined limit.

The ALDO1_PSM_ERR, ALDO2_PSM_ERR, and DLDO_PSM_ERR bits indicate either an LDO malfunction, or, if the LDOs are bypassed, an incorrect external supply.

The internal analog and digital voltage monitors can be disabled by appropriately selecting the LDO_PSM_TEST_EN bits.

Use the SAR ADC to verify the error.

Additionally, the levels of the internal monitors can be manually triggered to check if the detector works correctly by appropriately setting the LDO_PSM_TRIP_TEST_EN bits. These bits increase the comparator window threshold above the LDO outputs, forcing the comparator to trigger.

ROM and Memory Map CRC

If an error is found at power-up during the ROM verification, or if the internal memory map is corrupted, the AD7771 generates an error and sets MEMMAP_CRC_ERR or ROM_CRC_ERR, depending on the source of the error.

The checker can be disabled by clearing the MEMMAP_CRC_TEST_EN and ROM_CRC_TEST_EN bits.

The device must be reset if any of these errors trigger.

Σ - Δ ADC Errors

Reference Detect (SPI Control Mode)

In SPI control mode, the AD7771 includes on-chip circuitry to detect if there is a valid reference for conversions or calibrations. If the voltage between the selected REF_{x+} and REF_{x-} pins goes below 0.7 V, the AD7771 detects that it no longer has a valid reference. CH_x_ERR_REF_DET can be interrogated to identify the affected channel, which clears the bits if the error is no longer present. The voltage detector can be disabled by clearing the REF_DET_TEST_EN bit.

Use the Σ - Δ ADC diagnostic or the SAR ADC to verify the error.

Overvoltage and Undervoltage Events

The AD7771 includes on-chip overvoltage/undervoltage circuitry on each analog input pin. When the voltage on an analog input pin goes above AVDD_{1x} + 0.04 mV, the CH_x_ERR_AIN_x_OV bit is set. The error disappears if the input voltage falls below AVDD_{1x} - 40 mV.

If an undervoltage event occurs (AVSS_x - 40 mV), the CH_x_ERR_AIN_x_UV bit is set. The error disappears if the input voltage increases to AVSS_x + 0.04 V.

The CH_x_ERR_AINM_UV, CH_x_ERR_AINM_OV, CH_x_ERR_AINP_UV, and CH_x_ERR_AINP_OV bits can be read back to verify the affected channel input, which clears the bits if the error is no longer present. The overvoltage and undervoltage detection can be disabled independently by clearing the AINM_UV_TEST_EN, AINM_OV_TEST_EN, AINP_UV_TEST_EN, or AINP_OV_TEST_EN bit.

The input voltage can be checked independently with the SAR ADC.

Modulator Saturation

The AD7771 includes modulator saturation detection on each of the Σ - Δ ADCs. If 20 consecutive codes for the modulator are either all 1s or 0s, this condition is flagged as a modulator saturation event. Reading CH_x_ERR_MOD_SAT clears the bit if the error corrects itself.

Modulator saturation detection can be disabled by clearing the MOD_SAT_TEST_EN bit.

Note that the modulator input voltage is attenuated internally, which means that a modulator output of all 1s or 0s represents a modulator that is out of bounds and that a $\overline{\text{RESET}}$ pulse is required.

Filter Saturation

The AD7771 includes digital filter saturation detection on each Σ - Δ ADC channel. This detection indicates that the filter output is out of bounds, which represents an output code approximately 20% higher than positive or negative full scale. Reading the CH_x_ERR_FILTER_SAT bit clears the bit if the error corrects itself.

The detection can be disabled by clearing FILTER_SAT_TEST_EN bit.

Output Saturation

An output saturation event can occur when gain and offset calibration causes the output from the digital filter to clip at either positive or negative full scale. The output does not wrap. Reading the CH_x_ERR_OUTPUT_SAT bit clears the bit if the error corrects itself.

The detection can be disabled by clearing OUTPUT_SAT_TEST_EN bit.

SPI Transmission Errors (SPI Control Mode)

All SPI errors clear after reading GEN_ERR_REG_1, which contains the SPI errors. These errors are not recovered automatically and, consequently, the ALERT pin and the ALERT bit remain set until the error register is read back.

CRC Checksum Error

If the CRC checksum is enabled by setting the SPI_CRC_TEST_EN bit, an error bit, SPI_CRC_ERR, is raised if the CRC message does not match the message computed by the AD7771 internal CRC block. If the CRC message does not match the internally computed message, the register is not updated.

SCLK Counter

If the number of clocks generated by the controller is not a multiple of 8 after $\overline{\text{CS}}$ is pulled high, an error bit, SPI_CLK_COUNT_ERR is raised. The last command multiple of 8 is executed; however, the SCLK counter can be disabled by setting the SPI_CLK_COUNT_TEST_EN bit.

Invalid Read

When attempting to read back an invalid register address, the SPI_INVALID_READ_ERR bit is set.

The invalid readback address detection can be disabled by setting the SPI_INVALID_READ_TEST_EN bit.

Invalid Write

When attempting to write to an invalid register address, the SPI_INVALID_WRITE_ERR bit is set.

The invalid write address detection can be disabled by setting the SPI_INVALID_WRITE_TEST_EN bit.

MONITORING USING THE AD7771 SAR ADC (SPI CONTROL MODE)

The AD7771 contains an on-chip SAR ADC for chip diagnostics, system diagnostics, or measurement verification. The SAR ADC has a 12-bit resolution. The AVDD4 and AVSS4 pins operate in complete independence of the Σ - Δ ADC supplies and, therefore, can be used for chip diagnostics in systems where functional safety is important. The reference for the SAR conversion process is taken from the SAR ADC supply voltage (AVDD4/AVSS4) and, therefore, the SAR analog input range is from AVSS4 to AVDD4.

The SAR ADC has a maximum throughput rate of 256 kSPS. The CONVST_SAR pin initiates a conversion on the SAR ADC. The maximum allowable frequency of the CONVST_SAR pin is 256 kHz. If consecutive conversions are performed in the SAR ADC, read back the result from the previous conversion before a new conversion is generated. Otherwise, the results are corrupted.

The SAR ADC is only available in SPI control mode. To read conversion results from the SAR ADC, set the SAR_DIAG_MODE_EN bit. After this bit is set, all data shifted out from the SDO pin originates from the SAR ADC conversion, as shown in Figure 121.

The CONVST_SAR signal can be internally deglitched to avoid false triggers.

Table 29. SAR Synchronization and Deglitching

| CONVST_DEGLITCH_DIS (Register 0x013, Bits[7:6]) | Effect on CONVST_SAR |
|---|--|
| 11 | CONVST_SAR goes directly to the SAR |
| 10 | CONVST_SAR reaches the SAR when it is 1.5/MCLK cycles wide |

Increase the acquisition time by 1.5/MCLK when the deglitch circuitry is enabled.

Prior to the SAR ADC, the AD7771 contains an internal multiplexer. This multiplexer can be configured over the SPI to set the inputs to the SAR ADC to be either internal circuit nodes (in the case of diagnostics) or to select the external AUXAIN+ and AUXAIN- pins.

Along with converting external voltages, the SAR ADC monitors the internal nodes on the AVDD, IOVDD, and DGND pins, and the DLDO and analog LDO (ALDO) outputs. Some voltages are internally attenuated by 6, and the resulting voltage is applied to the SAR ADC, as shown in Table 30. This is useful because variations in the power supply voltage can be monitored.

The input multiplexer of the SAR is controlled by the GLOBAL_MUX_CONFIG register, and the different inputs available are described in Table 30.

The SAR ADC also contains an SAR driver amplifier, as shown in Figure 122. This amplifier settles the SAR input to 12-bit accuracy within the t_{33} time. This driver amplifier helps minimize the kickback from the SAR converter to the global diagnostic mux input circuit nodes.

Use the auxiliary inputs, AUXAIN+ and AUXAIN-, to validate the Σ - Δ measurements. While operating in SPI control mode, the AD7771 has three available GPIOx ports controlled via the SPI. The GPIOx pins can be used to control an external, dual 8:1 multiplexer, which, in turn, samples the eight Σ - Δ channels. Use this diagnostic in applications where functional safety is required. This diagnostic aids in removing the need for a secondary external ADC to validate primary measurements on the Σ - Δ channels.

Temperature Sensor

The internal die temperature can be measured with an accuracy of $\pm 2^\circ\text{C}$. The differential voltage base emitter (DV_{BE}) is proportional to the temperature measured referred to 25°C .

$$\text{Temperature } (^\circ\text{C}) = \frac{DV_{BE} - 0.6 \text{ V}}{2 \text{ mV}}$$

Table 30. SAR Mux Inputs

| SAR Input | Positive Signal | Negative Signal | Attenuation $\div 6$ |
|-----------|-----------------|-----------------|----------------------|
| 0 | AUXAIN+ | AUXAIN- | No |
| 1 | DV_{BE} | AVSSx | No |
| 2 | REF1+ | REF1- | No |
| 3 | REF2+ | REF2- | No |
| 4 | REF_OUT | AVSSx | No |
| 5 | VCM | AVSSx | No |
| 6 | AREG1CAP | AVSSx | Yes |
| 7 | AREG2CAP | AVSSx | Yes |
| 8 | DREGCAP | DGND | Yes |
| 9 | AVDD1A | AVSSx | Yes |
| 10 | AVDD1B | AVSSx | Yes |
| 11 | AVDD2A | AVSSx | Yes |
| 12 | AVDD2B | AVSSx | Yes |
| 13 | IOVDD | DGND | Yes |
| 14 | AVDD4 | AVSSx | No |
| 15 | DGND | AVSSx | Yes |
| 16 | DGND | AVSSx | Yes |
| 17 | DGND | AVSSx | Yes |
| 18 | AVDD4 | AVSSx | Yes |
| 19 | REF1+ | AVSSx | No |
| 20 | REF2+ | AVSSx | No |
| 21 | AVSSx | AVDD4 | Yes |

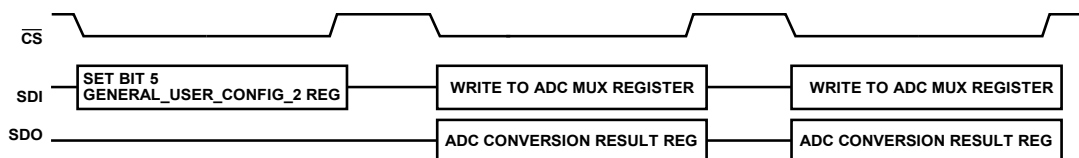

Figure 121. Configuring the AD7771 to Operate the SPI to Read from the SAR ADC

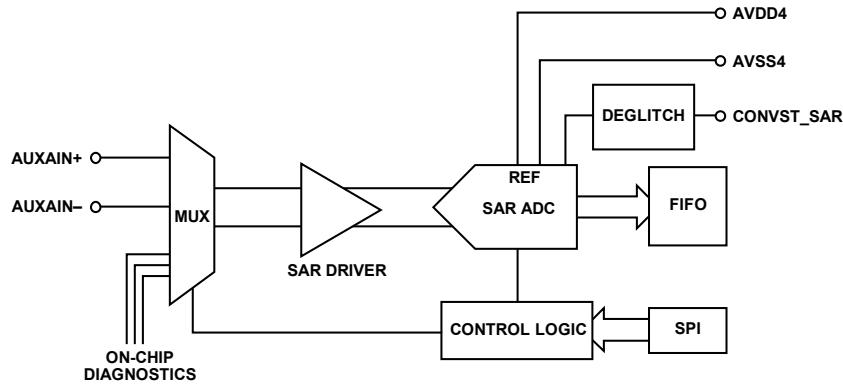

Figure 122. SAR ADC Configuration and Control

Table 31. Σ - Δ Diagnostic

| Input | Voltage | Recommended Voltage Reference | Notes/Result |
|-------|---------------------------------------|-------------------------------|-----------------------|
| 0 | Floating | Not applicable | Not applicable |
| 1 | Floating | Not applicable | Not applicable |
| 2 | 280 mV differential signal | Internal/external | PGA gain verification |
| 3 | External reference, positive/negative | External | Positive full scale |
| 4 | External reference, negative/positive | External | Negative full scale |
| 5 | External reference, negative/negative | External | Zero scale |
| 6 | Internal reference, positive/negative | Internal | Positive full scale |
| 7 | Internal reference, negative/positive | Internal | Negative full scale |
| 8 | Internal reference, positive/positive | Internal | Zero scale |
| 9 | External reference, positive/positive | External | Zero scale |

Σ - Δ ADC DIAGNOSTICS (SPI CONTROL MODE)

The AD7771 Σ - Δ ADC diagnostic functions are accessible through the SPI. The internal mux placed before the PGA has different inputs, allowing the user to select a zero-scale, positive full-scale, or negative full-scale input to the Σ - Δ ADC, which can be converted to verify the correct operation of the Σ - Δ ADC channel.

The diagnostic mux control signals are shared across all the Σ - Δ channels. Depending on the diagnostic selected, connect the Σ - Δ ADC reference to a different reference source to guarantee that the conversion is within the measurable range.

There are two different ways to enable the diagnostic mux, as follows:

- Setting the CH_x_RX bit. This bit enables the input Σ - Δ mux. The multiplexer inputs are described in Table 31. The reference used during the conversions are controlled by the REF_MUX_CTRL bits.
- Setting CH_x_REF_MONITOR. This bit has the same effect as enabling the CH_x_RX bit and selects the VDD1_x/AVSS_x supplies as the main reference.

If the AIN_x± pin is connected to AVSS_x, the input range is outside the range of AVSS_x + 100 mV; therefore, results may differ slightly from the expected value.

Alternatively, the inputs can be used to calibrate gain and offset errors.

Σ-Δ OUTPUT DATA

ADC CONVERSION OUTPUT—HEADER AND DATA

The AD7771 Σ-Δ conversion results are output on the DOUT0 to DOUT3 pins or over the SPI, depending on the selected interface. If the DOUTx interface is selected, the AD7771 acts as the master in the transmission. If the SPI is selected, the controller is the master.

The $\overline{\text{DRDY}}$ signal indicates the end of conversion independent of the interface selected to read back the Σ-Δ conversion. When the SPI reads back the Σ-Δ conversion, if a new conversion is completed ($\overline{\text{DRDY}}$ falling edge) before the previous conversion is read back, the results from previous conversion are overwritten and, consequently, the previous conversion data is corrupted.

For each channel, the width is 32 bits long: 8 bits for the header and 24 bits for the Σ-Δ conversion, as shown in Figure 123.

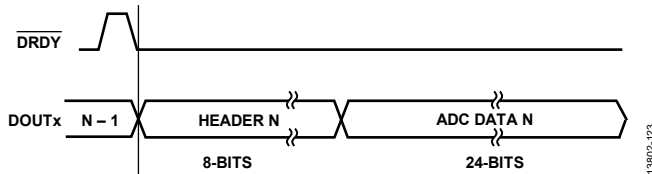

Figure 123. ADC Output—8-Bit Header Plus 24-Bit Conversion Data

In pin control mode, the header is fixed to the CRC while in SPI mode, and can be selected between the CRC and error headers.

CRC Header

The CRC header is the header generated in pin control mode or in SPI control mode if DOUT_HEADER_FORMAT is set.

As shown in Figure 124, the header consists of an alert bit, three bits for the ADC channel ID, as shown in Table 32, and four bits for the CRC.

The alert bit is set high if an error is detected in any channel, as explained in the General Errors section. The alert bit remains set to 1 until the error disappears.

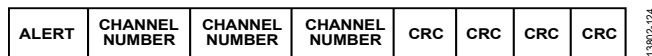

Figure 124. CRC Header

Table 32. Channel ID

| Channel | CH_ID_2 | CH_ID_1 | CH_ID_0 |
|---------|---------|---------|---------|
| 0 | 0 | 0 | 0 |
| 1 | 0 | 0 | 1 |
| 2 | 0 | 1 | 0 |
| 3 | 0 | 1 | 1 |
| 4 | 1 | 0 | 0 |
| 5 | 1 | 0 | 1 |
| 6 | 1 | 1 | 0 |
| 7 | 1 | 1 | 1 |

The CRC generated is eight bits long; the 4 MSBs are placed on the header for the first channel in the pairing and the 4 LSBs on the header of the second channel in the pairing, as shown in Table 33. If a channel is disabled, the 24-bit output data for this channel is 0x000000.

Table 33. 8-Bit CRC, Header Configuration (Channel 2)

| | | | | | | | |
|----|---|---|---|------|------|------|------|
| CE | 0 | 1 | 0 | CRC7 | CRC6 | CRC5 | CRC4 |
|----|---|---|---|------|------|------|------|

Table 34. 8-Bit CRC, Header Configuration (Channel 3)

| | | | | | | | |
|----|---|---|---|------|------|------|------|
| CE | 0 | 1 | 1 | CRC3 | CRC2 | CRC1 | CRC0 |
|----|---|---|---|------|------|------|------|

Error Header (SPI Control Mode)

In SPI control mode, the default header can be replaced by an error header. If the Σ-Δ conversion is read back through the SPI, disable the CRC by clearing the SPI_CRC_TEST_EN bit. If the DOUTx interface is used, clear the DOUT_HEADER_FORMAT bit.

The error header provides information of common error sources specific for each channel, as shown in Table 35. Modulator and filter errors are indicated even if the checker for these errors are specifically disabled, as described in the Σ-Δ ADC Errors section.

Table 35. Status Header Output

| Bits | Name | Description |
|------|--------------------|---|
| 7 | Alert | This bit is set high if any of the enabled diagnostic functions have detected an error, including an external clock not detected, a memory map bit flip, or an internal CRC error. This bit is not channel specific. This bit clears if the error is no longer present. |
| 6:4 | CH_ID_[2:0] | These bits indicate which ADC channel the following conversion data came from (see Table 32). |
| 3 | RESET_DETECTED | This bit indicates if a reset condition occurs. This bit is not channel specific. |
| 2 | MODULATOR_SATURATE | This bit indicates that the modulator output is 20 consecutive 0s or 1s. The bit resets automatically after the error is no longer present. |
| 1 | FILTER_SATURATE | This bit indicates that the filter output is out of bounds. The bit resets automatically after the error is no longer present. |
| 0 | AIN_OV_UVERROR | This bit indicates that there is an AINx± overvoltage/undervoltage condition on the inputs. This bit is set until the appropriate register is read back and the error is no longer present. |

SAMPLE RATE CONVERTER (SRC) (SPI CONTROL MODE)

The AD7771 implements a patented feature called the SRC on each Σ - Δ channel that allows the user to configure the output data rate or sampling frequency to any desired value, including noninteger values. The SRC achieves fine resolution control over the Σ - Δ ADC ODR, up to 15.2 μ SPS. In applications where the ODR must change based on changes in the input signal to maintain sampling coherency, the SRC provides fine control over the ODR. For example, to achieve the highest classification standard, Class A, in power quality applications, coherency must be maintained for 0.01 Hz changes in the input power line. Use the SRC to achieve this sampling frequency accuracy.

In pin control mode, the ODR is fixed per the predefined pin control options. Consequently, a noninteger number cannot be selected, as shown in Table 13.

To set the ODR, the user must program up to four registers, depending on the decimation value: two registers to program the integer value, N (the effective decimation rate), and two registers to program the decimal value, the interpolation factor (IF).

The integer value registers are SRC_N_MSB, Bits[3:0] and SRC_N_LSB, Bits[7:0]. The decimal part value registers are SRC_IF_MSB, Bits[7:0] and SRC_IF_LSB, Bits[7:0].

As an example, if an output data rate of 2.8 kHz is required, the decimation rate equates to

- High resolution mode = $2048/2.8 = 731.428$
- Low power mode = $512/2.8 = 182.857$

The register values for high resolution mode are as follows:

- 731 (decimal) = 0x2DB
- SRC_N_MSB, Bits[3:0] = 0x02
- SRC_N_LSB, Bits[7:0] = 0xDB
- 0.428 (decimal) = $0.428 \times 2^{16} = 28049$ (decimal) = 0x6D91
- SRC_IF_MSB, Bits[7:0] = 0x6D
- SRC_IF_LSB, Bits[7:0] = 0x91

The SRC resolution depends on the decimal number used in the decimation, as well as the modulator clock (MOD_MCLK), as follows:

$$Resolution = \frac{MOD_{MCLK}}{2^{16} \times DEC^2 + 3 \times DEC + 2 \times \frac{1}{2^{16}}}$$

where:

MOD_{MCLK} is the modulator frequency.

DEC is the decimal portion of the decimation rate.

In high resolution mode, for a decimal decimation of 450, the resolution is defined as

$$\frac{2048}{2^{16} \times 450^2 + 3 \times 450^2 \times \frac{1}{2^{16}}} = 15.2 \times 10^{-6} \text{ SPS}$$

The ODR can be updated on the fly, but a new ODR is effective in three conversion cycles of the Σ - Δ ADCs. This condition guarantees a smooth transition with no conversion results out of range.

There are two different ways to change the ODR after a new value is written in the SRC registers: via software or via hardware, depending on the SRC_LOAD_SOURCE bit (SRC_UPDATE register, Bit 7).

If the SRC_LOAD_SOURCE bit is clear, the new ODR value is updated by setting the SRC_LOAD_UPDATE bit to 1. This bit must be held high for at least two MCLK periods; return the bit to 0 before attempting another update.

If SRC_LOAD_SOURCE is set, the GPIO0 pin controls the ODR update externally. Apply a pulse in the GPIO2 pin, which is then internally synchronized with the external MCLK clock, and the resultant synchronous signal is output on the GPIO1 pin.

The GPIO1 and GPIO0 pins must be externally connected.

If multiple AD7771 devices must be synchronized, the GPIO1 pin of one device can be connected to multiple devices. This synchronization method requires the use of a common MCLK signal for all the AD7771 devices connected, as shown in Figure 125.

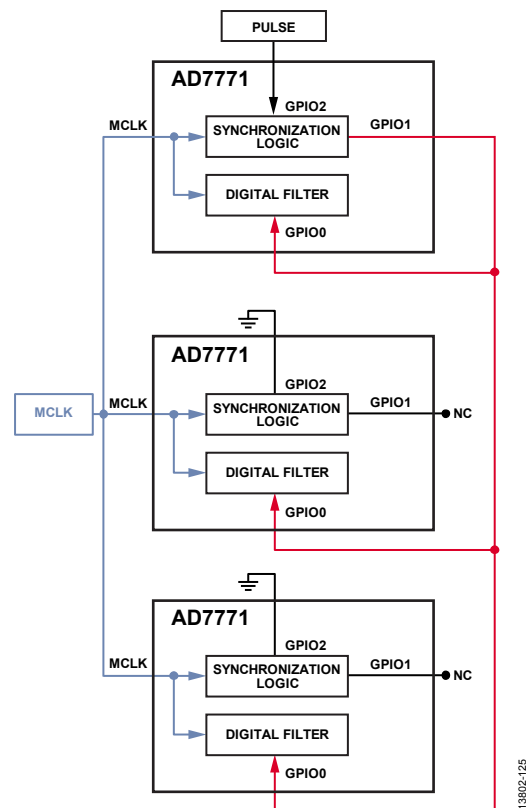

Figure 125. Hardware ODR Update

13802-125

SRC Bandwidth

The sinc3 and sinc5 filters architecture allows the user to select a noninteger value as the decimation range. This versatility means that the filter notches must be adjusted dynamically: two notches (sinc3) or four notches (sinc5) at the variable frequency, and one fixed notch to remove the PGA chopping tone. Consequently, the traditional formula for the -0.1 dB and -3 dB bandwidth must be adjusted depending on the selected decimation rate.

The bandwidth transfer function is not linear but can be approximated by using a linear function.

Figure 126 to Figure 129 show the correction factor for the -0.1 dB and -3 dB bandwidth, respectively. In low power mode, the offset must be divided by 4. For example, for sinc5 when the ODR = 1000 SPS, the -0.1 dB point is

$$BW = 0.0377 \times 1000 + \frac{49.355}{4} = 50.03 \text{ Hz}$$

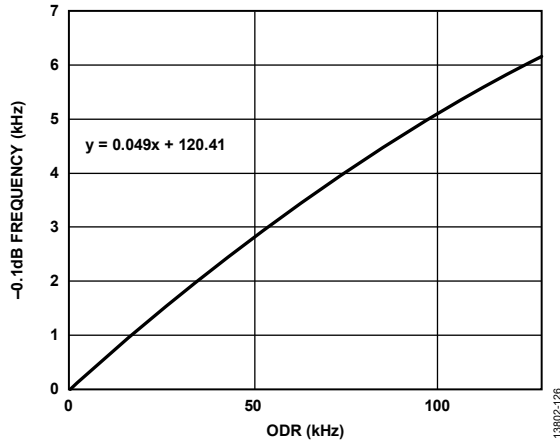

Figure 126. -0.1 dB Correction Factor, Sinc3 Filter Enabled

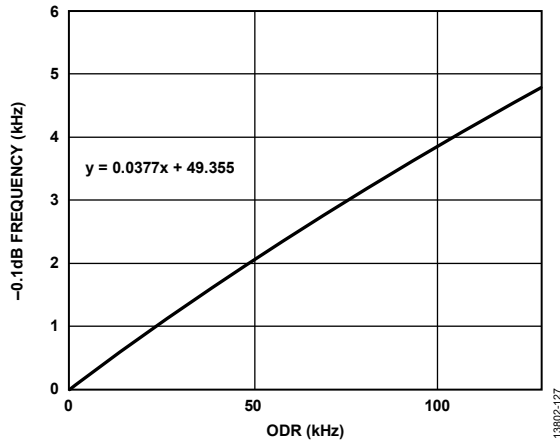

Figure 127. -0.1 dB Correction Factor, Sinc5 Filter Enabled

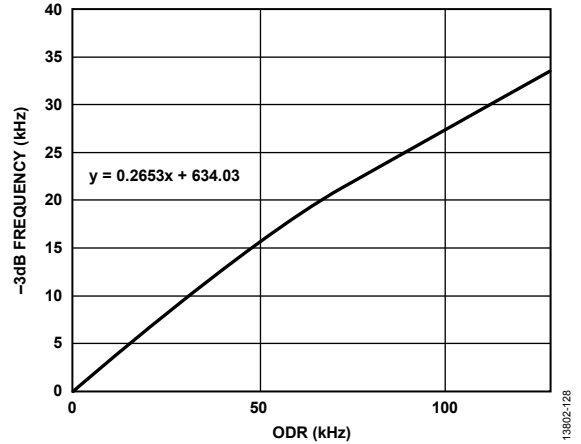

Figure 128. -3 dB Correction Factor, Sinc3 Filter Enabled

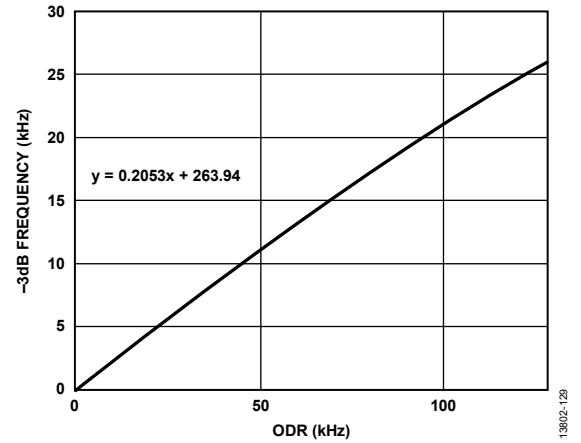

Figure 129. -3 dB Correction Factor, Sinc5 Filter Enabled

SRC Group Delay

The SRC group delay depends on the selected ODR and is defined by the following equation:

$$SRC \text{ Group Delay} = \frac{PM + SRC_N}{SRC_N \times ODR}$$

where:

PM is a constant equal to 8.

SRC_N is the integer value of the programmed ODR.

ODR is the programmed output data rate.

When using the sinc5 filter, the equation that defines the group delay is

$$SRC \text{ Group Delay} = \frac{PM + 2 \times SRC_N}{SRC_N \times ODR}$$

The latency is the contribution of the group delay and the calibration time.

$$Latency = Group \text{ Delay} + t_{CAL}$$

In high resolution mode, the calibration delay is defined as $62 \times t_{MCLK}$, with a maximum error of $2 \times t_{MCLK}$. In low power mode, the calibration delay is defined as $121 \times t_{MCLK}$, with a maximum error of $4 \times t_{MCLK}$. t_{MCLK} is the modulator period and is 488 ns in high resolution mode and 1.9 μ s in low power mode.

Settling Time

The settling time is defined by the contribution of all the internal stages, the filter delay, and the block calibration.

When using the sinc3 filter option, the filter delay is defined as 3/ODR. In some extreme cases, such as when an external pulse is applied, this value may increase to 4/ODR. If using the sinc5 filter, the filter delay is defined as 5/ODR, or 6/ODR for extreme cases.

DATA OUTPUT INTERFACE

The Σ - Δ output data interface is defined by the CONVST_SAR, FORMAT0, and FORMAT1 pins in pin control mode at power-up. The FORMATx pins cannot be changed dynamically. Table 14 shows the available options for pin control mode. If the device

is configured in SPI control mode, the SPI_SLAVE_MODE_EN bit enables the SPI to transmit the Σ - Δ ADC conversion results, as shown in Table 22.

DOUT3 to DOUT0 Data Interface

Standalone Mode

In standalone mode, the AD7771 interface acts as a master. There are three different DOUT configurations, configurable through the FORMATx pins in pin control mode, as shown in Figure 130 through Figure 132, or via the DOUT_FORMAT bits, Bits[7:6], in SPI control mode, as described in Table 36.

Figure 133, Figure 134, and Figure 135 show the expected data outputs for different DOUTx output modes.

Table 36. DOUTx Channels

| DOUT_FORMAT Bits/ FORMATx Pins | Number of DOUTx Lines Enabled | Associated Channels |
|-----------------------------------|----------------------------------|--|
| 00 | 4 | DOUT0—Channel 0 and Channel 1 DOUT1—Channel 2 and Channel 3 DOUT2—Channel 4 and Channel 5 DOUT3—Channel 6 and Channel 7 |
| 01 | 2 | DOUT0—Channel 0, Channel 1, Channel 2, and Channel 3 DOUT1—Channel 4, Channel 5, Channel 6, and Channel 7 |
| 10 or 11 | 1 | DOUT0—Channel 0, Channel 1, Channel 2, Channel 3, Channel 4, Channel 5, Channel 6, and Channel 7 |

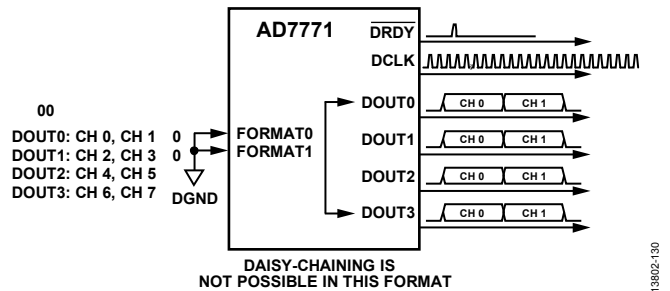

Figure 130. FORMATx Pin Configuration—FORMAT0 = 0, FORMAT1 = 0

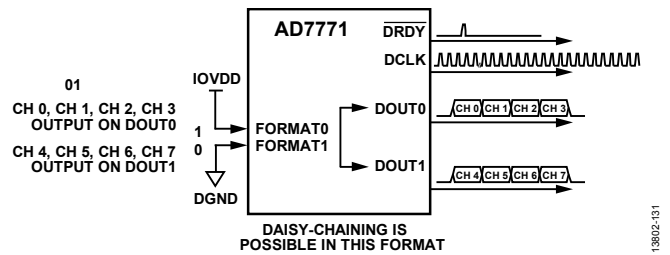

Figure 131. FORMATx Pin Configuration—FORMAT0 = 1, FORMAT1 = 0

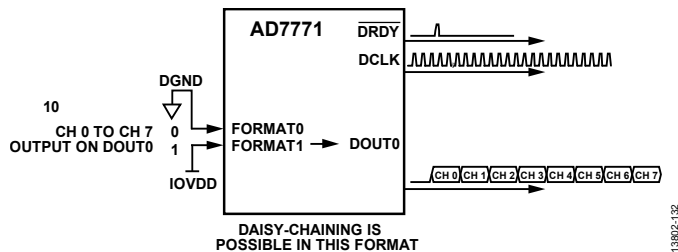

Figure 132. FORMATx Pin Configuration—FORMAT0 = 0, FORMAT1 = 1

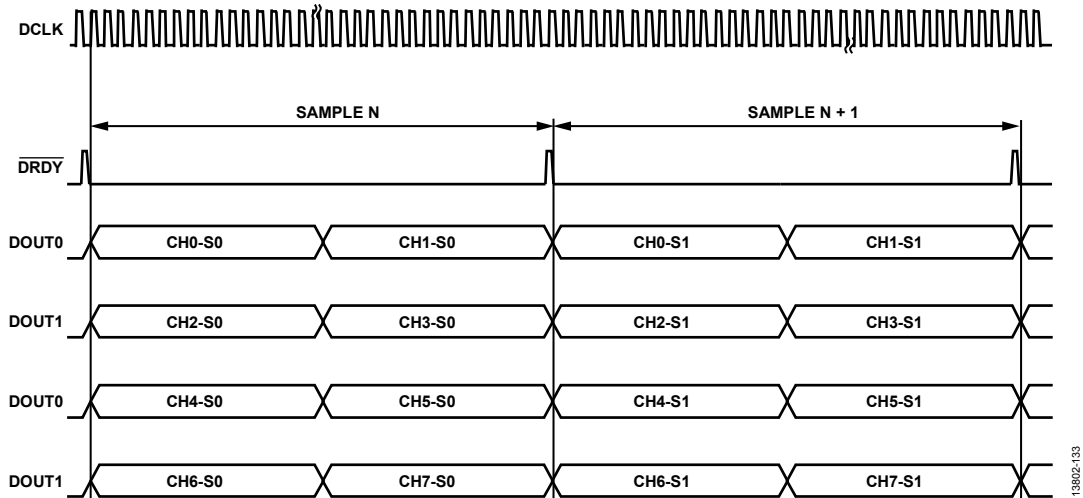

Figure 133. $FORMAT0 = 0, FORMAT1 = 0$ —Each $DOUTx$ Outputs Two ADC Conversions (S0 Means Sample 0 and S1 Means Sample 1)

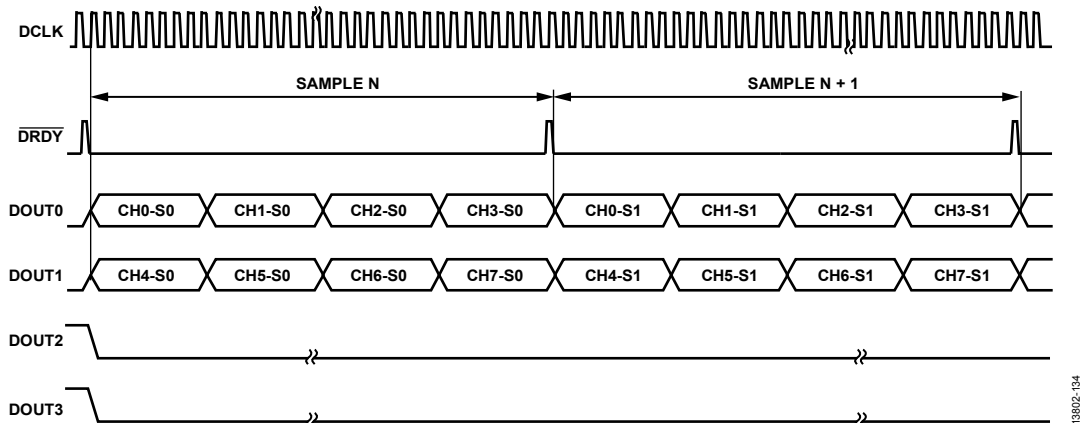

Figure 134. $FORMAT0 = 0, FORMAT1 = 1$ —Channel 0 to Channel 3 Share $DOUT0$, and Channel 4 to Channel 7 Share $DOUT1$ (S0 Means Sample 0 and S1 Means Sample 1)

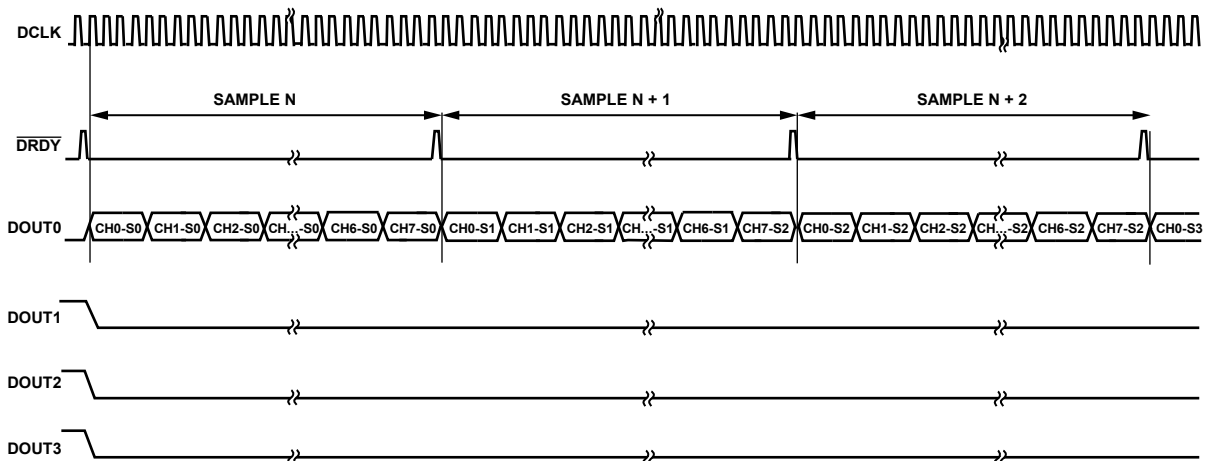

Figure 135. $FORMAT0 = 1, FORMAT1 = 0$ —Channel 0 to Channel 7 Output on $DOUT0$ Only (S0 Means Sample 0 and S1 Means Sample 1)

Daisy-Chain Mode

Daisy-chaining devices allows numerous devices to use the same data interface lines by cascading the outputs of multiple ADCs from separate AD7771 devices. In daisy-chain configuration, only one device has a direct connection between the DOUTx interface and the digital host. For the AD7771, daisy-chain capability is implemented by cascading DOUT0 and DOUT1 through a number of devices, or by just using DOUT0 (the number of DOUTx pins available depends on the selected DOUTx mode). The ability to daisy-chain devices and the limit on the number of devices that can be handled by the chain is dependent on the selected DOUTx mode and the decimation rate employed.

When operating in daisy-chain mode, it is required that all AD7771 devices in the chain are correctly synchronized. See

the Digital Reset and Synchronization Pins section for more information.

This feature is especially useful for reducing the component count and wiring connections in, for example, isolated multiconverter applications or for systems with a limited interfacing capacity.

For daisy-chain operation, there are two different configurations possible, as described in Table 37.

Using the FORMATx = 10 mode, DOUT2 acts as an input pin, as shown in Figure 136. In this case, the DOUT0 pin of the AD7771 devices is cascaded to the DOUT2 pin of the next device in the chain. Data readback is analogous to clocking a shift register where data is clocked on the rising edge of DCLK.

Table 37. DOUTx Modes in Daisy-Chain Operation

| DOUT_FORMAT Bits/ FORMATx Pins | Number of DOUTx Lines Enabled | Associated Channels |
|-----------------------------------|-------------------------------|--|
| 01 | 2 | DOUT0—Channel 0 to Channel 3 and DOUT2 DOUT1—Channel 4 to Channel 7 and DOUT3 DOUT2—input channel DOUT3—input channel |
| 10 | 1 | DOUT0—Channel 0 to Channel 7 and DOUT2 DOUT2—input channel |

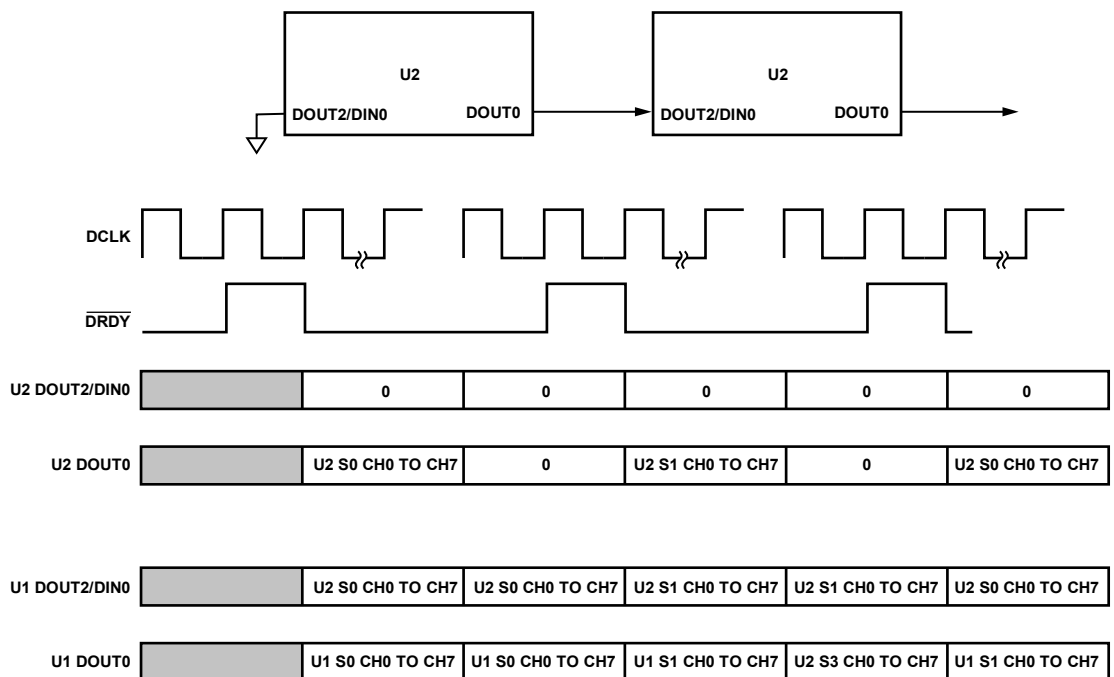

Figure 136. Daisy-Chain Connection Mode, FORMAT0 = 1, FORMAT1 = 0 (S0 Means Sample 0 and S1 Means Sample 1); When Connected in Daisy-Chain Mode, DOUT2 Acts as an Input Pin, Represented by DIN0

Minimum DCLKx Frequency

Select the DCLKx frequency ratio in such a way that the data is completely shifted out before a new conversion is completed; otherwise, the previous conversion is overwritten and the transmission becomes corrupt. The minimum DCLKx frequency ratio is defined by the decimation rate, the operation mode, and the lines enabled on the DOUT3 to DOUT0 data interface as described in the following equations:

In standalone, high resolution mode,

$$DCLK_{MIN_RATIO} < Decimation / (8 \times DOUT_FORMAT)$$

In standalone, low power mode,

$$DCLK_{MIN_RATIO} < Decimation / (4 \times DOUT_FORMAT)$$

In daisy-chain, high resolution mode,

$$DCLK_{MIN_RATIO} < Decimation / (8 \times Devices \times DOUTx\ Channels)$$

In daisy-chain, low power mode,

$$DCLK_{MIN_RATIO} < Decimation / (4 \times Devices \times DOUTx\ Channels)$$

As an example, when operating in master interface mode, $FORMATx = 01$, the DOUT0 and DOUT1 pins shift out four Σ - Δ channels each and, assuming a maximum output rate in high resolution mode, the decimation = 128.

$$DCLK_{MIN} < 128 / (8 \times 4) = 4$$

If the $DCLK_{MIN_RATIO}$ is selected above the necessary minimum, a Logic 0 is continuously transmitted until a new sample is available.

An example in daisy-chain mode, assuming $FORMATx = 01$, and with three devices connected and a decimation rate of 256 in high resolution mode, is as follows:

$$DCLK_{MIN_RATIO} < 256 / (8 \times 3 \times 4) = 2.66 = 2$$

The different ratios are summarized in Table 38.

Table 38. Available DCLK Ratios

| DCLK_CLK_DIV (SPI Control Mode), DCLKx (Pin Control Mode) | DCLKx Ratio |
|--|-------------|
| 000 | 1 |
| 001 | 2 |
| 010 | 4 |
| 011 | 8 |
| 100 | 16 |
| 101 | 32 |
| 110 | 64 |
| 111 | 128 |

There are maximum achievable ODRs and minimum DCLKx frequencies required for a given DOUTx pin configuration, as shown in Table 39 and Table 40.

Table 39. Maximum ODRs and Minimum DCLKx Frequencies in High Resolution Mode

| Decimation Rate | ODR (kSPS) | Minimum DCLKx (kHz) ¹ | | |
|-----------------|------------|----------------------------------|-----------|-----------|
| | | 1 × DOUTx | 2 × DOUTx | 4 × DOUTx |
| 4095 | 0.500122 | 128 | 64 | 32 |
| 2048 | 1 | 256 | 128 | 64 |
| 1024 | 2 | 512 | 256 | 128 |
| 512 | 4 | 1024 | 512 | 256 |
| 256 | 8 | 2048 | 1024 | 512 |
| 128 | 16 | 4096 | 2048 | 1024 |
| 64 | 32 | 8192 | 4096 | 2048 |
| 32 | 64 | N/A | 8192 | 4096 |
| 16 | 128 | N/A | N/A | 8192 |

¹ N/A means not applicable.

Table 40. Maximum ODRs and Minimum DCLKx Frequencies in Low Power Mode

| Decimation Rate | ODR (kSPS) | Minimum DCLKx (kHz) | | |
|-----------------|------------|---------------------|-----------|-----------|
| | | 1 × DOUTx | 2 × DOUTx | 4 × DOUTx |
| 2048 | 0.25 | 64 | 32 | 16 |
| 1024 | 0.5 | 128 | 64 | 32 |
| 512 | 1 | 256 | 128 | 64 |
| 256 | 2 | 512 | 256 | 128 |
| 128 | 4 | 1024 | 512 | 256 |
| 64 | 8 | 2048 | 1024 | 512 |
| 32 | 16 | 4096 | 2048 | 1024 |
| 16 | 32 | N/A ¹ | 4096 | 2048 |

¹ N/A means not applicable.

If the AD7771 operates in SPI control mode, it is possible to adjust the DOUTx strength, which can be selected in the DOUT_DRIVE_STR bits, as described in Table 41.

Table 41. DOUTx Strength

| DOUT_DRIVE_STR | Mode |
|----------------|--------------|
| 00 | Nominal |
| 01 | Strong |
| 10 | Weak |
| 11 | Extra strong |

SPI

The SPI gives the user flexibility to read the conversion from the Σ - Δ ADC where the processor or microcontroller is the master.

When a new conversion is completed, the \overline{DRDY} signal is toggled to indicate that data can be accessed. When \overline{DRDY} toggles, the internal channel counter is reset and the next SPI read originates from Channel 0 again. Conversely, after the last channel data is read, all successive reads before the next \overline{DRDY} signal originate from Channel 7 (LSB).

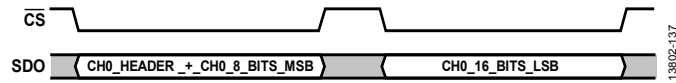

Figure 137. SPI Readback, 16 Bits per Frame

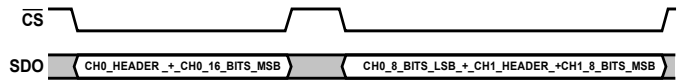

Figure 138. SPI Readback, 24 Bits per Frame

The SPI operates in multiples of 8 bits per frame; Figure 137 shows a readback example in 16 bits per frames, and Figure 138 shows a readback in 24 bits per frame.

Note that if the device is configured in SPI control mode, the AD7771 generates a software reset if the SDI pin is sampled high for 64 consecutive clocks. To avoid a reset or unwanted register writes, it is recommended to transfer a 0x8000 command, which generates a readback command that is ignored by the device, as explained in the SPI Software Reset section.

CALCULATING THE CRC CHECKSUM

The AD7771 implements two different CRC checksum generators, one for the Σ - Δ results and another for the SPI control mode.

The AD7771 uses a CRC polynomial to calculate the CRC checksum value. The 8-bit CRC polynomial used is $x^8 + x^2 + x + 1$.

The polynomial is aligned so that its MSB is adjacent to the leftmost Logic 1 of the data. An exclusive OR (XOR) function is applied to the data to produce a new, shorter number. The polynomial is again aligned so that its MSB is adjacent to the leftmost Logic 1 of the new result, and the procedure is repeated. This process is repeated until the original data is reduced to a value less than the polynomial. This is the 8-bit checksum.

An example of CRC calculation for 12-bit data is shown in Table 42.

Table 42. Example CRC Calculation for 12-Bit Data¹

| Data | 0 | 1 | 1 | 0 | 0 | 1 | 0 | 0 | 1 | 1 | 1 | 0 |
|------------|---|---|---|---|---|---|---|---|---|---|---|---|
| Polynomial | | 1 | 0 | 0 | 0 | 0 | 0 | 1 | 1 | | | |
| | | | 1 | 0 | 0 | 1 | 0 | 1 | 0 | 1 | 1 | 0 |
| | | | 1 | 0 | 0 | 0 | 0 | 0 | 1 | 1 | | |
| CRC | | | | | 0 | 1 | 0 | 1 | 1 | 1 | 1 | 0 |

¹ This table represents the division of the data; blank cells are for formatting purposes.

Σ - Δ CRC Checksum

The CRC message is calculated internally by the AD7771 on ADC pairs. The CRC is calculated using the ADC output data from two ADCs and Bits[7:4] from the header. Therefore, 56 bits are used to calculate the 8-bit CRC. This CRC is split between the two channel headers. The CRC data covers channel pairings as follows: Channel 0 and Channel 1, Channel 2 and Channel 3, Channel 4 and Channel 5, and Channel 6 and Channel 7.

To generate the checksum, the data is left shifted by eight bits to create a number ending in eight Logic 1s.

The CRC is calculated from 56 bits across two consecutive/channel pairings (Channel 0 and Channel 1, Channel 2 and Channel 3, Channel 4 and Channel 5, Channel 6, and Channel 7). The 56 bits consist of the alert bit, the 3 bits for the first ADC pairing channel, and the 24 bits of data of each pairing channel. For example, for the second channel pairing, Channel 2 and Channel 3,

$$56 \text{ bits} = \text{alert bit} + 3 \text{ ADC channel bits (010)} + 24 \text{ data bits (Channel 2)} + \text{alert bit} + 3 \text{ ADC channel bits (011)} + 24 \text{ data bits (Channel 3)}$$

SPI Control Mode Checksum

The CRC message is calculated internally by the AD7771. The data transferred to the AD7771 uses the R/W bit, a 7-bit address, and 8 bits of data for the CRC calculation.

The CRC calculated and appended to the data that is shifted out uses a 0010 0000 header and 8 bits of data for the register readback, as well as the 0010 header and 12 bits of SAR conversion data for the SAR readback transfers.

REGISTER SUMMARY

Table 43. Register Summary

| Reg. | Name | Bits | Bit 7 | Bit 6 | Bit 5 | Bit 4 | Bit 3 | Bit 2 | Bit 1 | Bit 0 | Reset | R/W | |
|-------|-----------------------|-------|-----------------------|---------------|--------------------|-------------------|----------------|------------------|------------------|-----------------|-------|------|-----|
| 0x000 | CH0_CONFIG | [7:0] | CH0_GAIN | | CH0_REF_MONITOR | CH0_RX | RESERVED | | | | 0x00 | /W R | |
| 0x001 | CH1_CONFIG | [7:0] | CH1_GAIN | | CH1_REF_MONITOR | CH1_RX | RESERVED | | | | 0x00 | R/W | |
| 0x002 | CH2_CONFIG | [7:0] | CH2_GAIN | | CH2_REF_MONITOR | CH2_RX | RESERVED | | | | 0x00 | R/W | |
| 0x003 | CH3_CONFIG | [7:0] | CH3_GAIN | | CH3_REF_MONITOR | CH3_RX | RESERVED | | | | 0x00 | R/W | |
| 0x004 | CH4_CONFIG | [7:0] | CH4_GAIN | | CH4_REF_MONITOR | CH4_RX | RESERVED | | | | 0x00 | R/W | |
| 0x005 | CH5_CONFIG | [7:0] | CH5_GAIN | | CH5_REF_MONITOR | CH5_RX | RESERVED | | | | 0x00 | R/W | |
| 0x006 | CH6_CONFIG | [7:0] | CH6_GAIN | | CH6_REF_MONITOR | CH6_RX | RESERVED | | | | 0x00 | R/W | |
| 0x007 | CH7_CONFIG | [7:0] | CH7_GAIN | | CH7_REF_MONITOR | CH7_RX | RESERVED | | | | 0x00 | R/W | |
| 0x008 | CH_DISABLE | [7:0] | CH7_DISABLE | CH6_DISABLE | CH5_DISABLE | CH4_DISABLE | CH3_DISABLE | CH2_DISABLE | CH1_DISABLE | CH0_DISABLE | 0x00 | R/W | |
| 0x009 | CH0_SYNC_OFFSET | [7:0] | CH0_SYNC_OFFSET | | | | | | | | | 0x00 | R/W |
| 0x00A | CH1_SYNC_OFFSET | [7:0] | CH1_SYNC_OFFSET | | | | | | | | | 0x00 | R/W |
| 0x00B | CH2_SYNC_OFFSET | [7:0] | CH2_SYNC_OFFSET | | | | | | | | | 0x00 | R/W |
| 0x00C | CH3_SYNC_OFFSET | [7:0] | CH3_SYNC_OFFSET | | | | | | | | | 0x00 | R/W |
| 0x00D | CH4_SYNC_OFFSET | [7:0] | CH4_SYNC_OFFSET | | | | | | | | | 0x00 | R/W |
| 0x00E | CH5_SYNC_OFFSET | [7:0] | CH5_SYNC_OFFSET | | | | | | | | | 0x00 | R/W |
| 0x00F | CH6_SYNC_OFFSET | [7:0] | CH6_SYNC_OFFSET | | | | | | | | | 0x00 | R/W |
| 0x010 | CH7_SYNC_OFFSET | [7:0] | CH7_SYNC_OFFSET | | | | | | | | | 0x00 | R/W |
| 0x011 | GENERAL_USER_CONFIG_1 | [7:0] | ALL_CH_DIS_MCLK_EN | POWER-MODE | PDB_VCM | PDB_REFOUT_BUF | PDB_SAR | PDB_RC_OSC | SOFT_RESET | | 0x24 | R/W | |
| 0x012 | GENERAL_USER_CONFIG_2 | [7:0] | RESERVED | FILTER_MODE | SAR_DIAG_MODE_EN | SDO_DRIVE_STR | | DOUT_DRIVE_STR | | SPI_SYNC | 0x09 | R/W | |
| 0x013 | GENERAL_USER_CONFIG_3 | [7:0] | CONVST_DEGLITCH_DIS | | RESERVED | SPI_SLAVE_MODE_EN | RESERVED | | | CLK_QUAL_DIS | 0x80 | R/W | |
| 0x014 | DOUT_FORMAT | [7:0] | DOUT_FORMAT | | DOUT_HEADER_FORMAT | RESERVED | DCLK_CLK_DIV | | | RESERVED | 0x20 | R/W | |
| 0x015 | ADC_MUX_CONFIG | [7:0] | REF_MUX_CTRL | | MTR_MUX_CTRL | | | | RESERVED | | 0x00 | R/W | |
| 0x016 | GLOBAL_MUX_CONFIG | [7:0] | GLOBAL_MUX_CTRL | | | | | RESERVED | | | | 0x00 | R/W |
| 0x017 | GPIO_CONFIG | [7:0] | RESERVED | | | | | GPIO_OP_EN | | | | 0x00 | R/W |
| 0x018 | GPIO_DATA | [7:0] | RESERVED | | GPIO_READ_DATA | | | GPIO_WRITE_DATA | | | 0x00 | R/W | |
| 0x019 | BUFFER_CONFIG_1 | [7:0] | RESERVED | | | REF_BUF_POS_EN | REF_BUF_NEG_EN | RESERVED | | | | 0x38 | R/W |
| 0x01A | BUFFER_CONFIG_2 | [7:0] | REF-BUFP_PREQ | REF-BUFN_PREQ | RESERVED | | | PDB_ALDO1_OVRDRV | PDB_ALDO2_OVRDRV | PDB_DLDO_OVRDRV | 0xC0 | R/W | |
| 0x01C | CH0_OFFSET_UPPER_BYTE | [7:0] | CH0_OFFSET_ALL[23:16] | | | | | | | | | 0x00 | R/W |
| 0x01D | CH0_OFFSET_MID_BYTE | [7:0] | CH0_OFFSET_ALL[15:8] | | | | | | | | | 0x00 | R/W |

| Reg. | Name | Bits | Bit 7 | Bit 6 | Bit 5 | Bit 4 | Bit 3 | Bit 2 | Bit 1 | Bit 0 | Reset | R/W | |
|-------|-----------------------|-------|-------|-------|-------|-----------------------|-------|-------|-------|-------|-------|------|-----|
| 0x01E | CH0_OFFSET_LOWER_BYTE | [7:0] | | | | CH0_OFFSET_ALL[7:0] | | | | | | 0x00 | R/W |
| 0x01F | CH0_GAIN_UPPER_BYTE | [7:0] | | | | CH0_GAIN_ALL[23:16] | | | | | | 0x00 | R/W |
| 0x020 | CH0_GAIN_MID_BYTE | [7:0] | | | | CH0_GAIN_ALL[15:8] | | | | | | 0x00 | R/W |
| 0x021 | CH0_GAIN_LOWER_BYTE | [7:0] | | | | CH0_GAIN_ALL[7:0] | | | | | | 0x00 | R/W |
| 0x022 | CH1_OFFSET_UPPER_BYTE | [7:0] | | | | CH1_OFFSET_ALL[23:16] | | | | | | 0x00 | R/W |
| 0x023 | CH1_OFFSET_MID_BYTE | [7:0] | | | | CH1_OFFSET_ALL[15:8] | | | | | | 0x00 | R/W |
| 0x024 | CH1_OFFSET_LOWER_BYTE | [7:0] | | | | CH1_OFFSET_ALL[7:0] | | | | | | 0x00 | R/W |
| 0x025 | CH1_GAIN_UPPER_BYTE | [7:0] | | | | CH1_GAIN_ALL[23:16] | | | | | | 0x00 | R/W |
| 0x026 | CH1_GAIN_MID_BYTE | [7:0] | | | | CH1_GAIN_ALL[15:8] | | | | | | 0x00 | R/W |
| 0x027 | CH1_GAIN_LOWER_BYTE | [7:0] | | | | CH1_GAIN_ALL[7:0] | | | | | | 0x00 | R/W |
| 0x028 | CH2_OFFSET_UPPER_BYTE | [7:0] | | | | CH2_OFFSET_ALL[23:16] | | | | | | 0x00 | R/W |
| 0x029 | CH2_OFFSET_MID_BYTE | [7:0] | | | | CH2_OFFSET_ALL[15:8] | | | | | | 0x00 | R/W |
| 0x02A | CH2_OFFSET_LOWER_BYTE | [7:0] | | | | CH2_OFFSET_ALL[7:0] | | | | | | 0x00 | R/W |
| 0x02B | CH2_GAIN_UPPER_BYTE | [7:0] | | | | CH2_GAIN_ALL[23:16] | | | | | | 0x00 | R/W |
| 0x02C | CH2_GAIN_MID_BYTE | [7:0] | | | | CH2_GAIN_ALL[15:8] | | | | | | 0x00 | R/W |
| 0x02D | CH2_GAIN_LOWER_BYTE | [7:0] | | | | CH2_GAIN_ALL[7:0] | | | | | | 0x00 | R/W |
| 0x02E | CH3_OFFSET_UPPER_BYTE | [7:0] | | | | CH3_OFFSET_ALL[23:16] | | | | | | 0x00 | R/W |
| 0x02F | CH3_OFFSET_MID_BYTE | [7:0] | | | | CH3_OFFSET_ALL[15:8] | | | | | | 0x00 | R/W |
| 0x030 | CH3_OFFSET_LOWER_BYTE | [7:0] | | | | CH3_OFFSET_ALL[7:0] | | | | | | 0x00 | R/W |
| 0x031 | CH3_GAIN_UPPER_BYTE | [7:0] | | | | CH3_GAIN_ALL[23:16] | | | | | | 0x00 | R/W |
| 0x032 | CH3_GAIN_MID_BYTE | [7:0] | | | | CH3_GAIN_ALL[15:8] | | | | | | 0x00 | R/W |
| 0x033 | CH3_GAIN_LOWER_BYTE | [7:0] | | | | CH3_GAIN_ALL[7:0] | | | | | | 0x00 | R/W |
| 0x034 | CH4_OFFSET_UPPER_BYTE | [7:0] | | | | CH4_OFFSET_ALL[23:16] | | | | | | 0x00 | R/W |
| 0x035 | CH4_OFFSET_MID_BYTE | [7:0] | | | | CH4_OFFSET_ALL[15:8] | | | | | | 0x00 | R/W |
| 0x036 | CH4_OFFSET_LOWER_BYTE | [7:0] | | | | CH4_OFFSET_ALL[7:0] | | | | | | 0x00 | R/W |
| 0x037 | CH4_GAIN_UPPER_BYTE | [7:0] | | | | CH4_GAIN_ALL[23:16] | | | | | | 0x00 | R/W |
| 0x038 | CH4_GAIN_MID_BYTE | [7:0] | | | | CH4_GAIN_ALL[15:8] | | | | | | 0x00 | R/W |
| 0x039 | CH4_GAIN_LOWER_BYTE | [7:0] | | | | CH4_GAIN_ALL[7:0] | | | | | | 0x00 | R/W |
| 0x03A | CH5_OFFSET_UPPER_BYTE | [7:0] | | | | CH5_OFFSET_ALL[23:16] | | | | | | 0x00 | R/W |
| 0x03B | CH5_OFFSET_MID_BYTE | [7:0] | | | | CH5_OFFSET_ALL[15:8] | | | | | | 0x00 | R/W |
| 0x03C | CH5_OFFSET_LOWER_BYTE | [7:0] | | | | CH5_OFFSET_ALL[7:0] | | | | | | 0x00 | R/W |
| 0x03D | CH5_GAIN_UPPER_BYTE | [7:0] | | | | CH5_GAIN_ALL[23:16] | | | | | | 0x00 | R/W |
| 0x03E | CH5_GAIN_MID_BYTE | [7:0] | | | | CH5_GAIN_ALL[15:8] | | | | | | 0x00 | R/W |

| Reg. | Name | Bits | Bit 7 | Bit 6 | Bit 5 | Bit 4 | Bit 3 | Bit 2 | Bit 1 | Bit 0 | Reset | R/W |
|-------|-----------------------|-------|-----------------------|--------------------|--------------------|---------------------|-----------------------|--------------------------|---------------------------|--------------------|-------|-----|
| 0x03F | CH5_GAIN_LOWER_BYTE | [7:0] | CH5_GAIN_ALL[7:0] | | | | | | | | 0x00 | R/W |
| 0x040 | CH6_OFFSET_UPPER_BYTE | [7:0] | CH6_OFFSET_ALL[23:16] | | | | | | | | 0x00 | R/W |
| 0x041 | CH6_OFFSET_MID_BYTE | [7:0] | CH6_OFFSET_ALL[15:8] | | | | | | | | 0x00 | R/W |
| 0x042 | CH6_OFFSET_LOWER_BYTE | [7:0] | CH6_OFFSET_ALL[7:0] | | | | | | | | 0x00 | R/W |
| 0x043 | CH6_GAIN_UPPER_BYTE | [7:0] | CH6_GAIN_ALL[23:16] | | | | | | | | 0x00 | R/W |
| 0x044 | CH6_GAIN_MID_BYTE | [7:0] | CH6_GAIN_ALL[15:8] | | | | | | | | 0x00 | R/W |
| 0x045 | CH6_GAIN_LOWER_BYTE | [7:0] | CH6_GAIN_ALL[7:0] | | | | | | | | 0x00 | R/W |
| 0x046 | CH7_OFFSET_UPPER_BYTE | [7:0] | CH7_OFFSET_ALL[23:16] | | | | | | | | 0x00 | R/W |
| 0x047 | CH7_OFFSET_MID_BYTE | [7:0] | CH7_OFFSET_ALL[15:8] | | | | | | | | 0x00 | R/W |
| 0x048 | CH7_OFFSET_LOWER_BYTE | [7:0] | CH7_OFFSET_ALL[7:0] | | | | | | | | 0x00 | R/W |
| 0x049 | CH7_GAIN_UPPER_BYTE | [7:0] | CH7_GAIN_ALL[23:16] | | | | | | | | 0x00 | R/W |
| 0x04A | CH7_GAIN_MID_BYTE | [7:0] | CH7_GAIN_ALL[15:8] | | | | | | | | 0x00 | R/W |
| 0x04B | CH7_GAIN_LOWER_BYTE | [7:0] | CH7_GAIN_ALL[7:0] | | | | | | | | 0x00 | R/W |
| 0x04C | CH0_ERR_REG | [7:0] | RESERVED | | CH0_ERR_AINM_UV | CH0_ERR_AINM_OV | CH0_ERR_AINP_UV | CH0_ERR_AINP_OV | CH0_ERR_REF_DET | 0x00 | R | |
| 0x04D | CH1_ERR_REG | [7:0] | RESERVED | | CH1_ERR_AINM_UV | CH1_ERR_AINM_OV | CH1_ERR_AINP_UV | CH1_ERR_AINP_OV | CH1_ERR_REF_DET | 0x00 | R | |
| 0x04E | CH2_ERR_REG | [7:0] | RESERVED | | CH2_ERR_AINM_UV | CH2_ERR_AINM_OV | CH2_ERR_AINP_UV | CH2_ERR_AINP_OV | CH2_ERR_REF_DET | 0x00 | R | |
| 0x04F | CH3_ERR_REG | [7:0] | RESERVED | | CH3_ERR_AINM_UV | CH3_ERR_AINM_OV | CH3_ERR_AINP_UV | CH3_ERR_AINP_OV | CH3_ERR_REF_DET | 0x00 | R | |
| 0x050 | CH4_ERR_REG | [7:0] | RESERVED | | CH4_ERR_AINM_UV | CH4_ERR_AINM_OV | CH4_ERR_AINP_UV | CH4_ERR_AINP_OV | CH4_ERR_REF_DET | 0x00 | R | |
| 0x051 | CH5_ERR_REG | [7:0] | RESERVED | | CH5_ERR_AINM_UV | CH5_ERR_AINM_OV | CH5_ERR_AINP_UV | CH5_ERR_AINP_OV | CH5_ERR_REF_DET | 0x00 | R | |
| 0x052 | CH6_ERR_REG | [7:0] | RESERVED | | CH6_ERR_AINM_UV | CH6_ERR_AINM_OV | CH6_ERR_AINP_UV | CH6_ERR_AINP_OV | CH6_ERR_REF_DET | 0x00 | R | |
| 0x053 | CH7_ERR_REG | [7:0] | RESERVED | | CH7_ERR_AINM_UV | CH7_ERR_AINM_OV | CH7_ERR_AINP_UV | CH7_ERR_AINP_OV | CH7_ERR_REF_DET | 0x00 | R | |
| 0x054 | CH0_1_SAT_ERR | [7:0] | RESERVED | | CH1_ERR_MOD_SAT | CH1_ERR_FILTER_SAT | CH1_ERR_OUTPUT_SAT | CH0_ERR_MOD_SAT | CH0_ERR_FILTER_SAT | CH0_ERR_OUTPUT_SAT | 0x00 | R |
| 0x055 | CH2_3_SAT_ERR | [7:0] | RESERVED | | CH3_ERR_MOD_SAT | CH3_ERR_FILTER_SAT | CH3_ERR_OUTPUT_SAT | CH2_ERR_MOD_SAT | CH2_ERR_FILTER_SAT | CH2_ERR_OUTPUT_SAT | 0x00 | R |
| 0x056 | CH4_5_SAT_ERR | [7:0] | RESERVED | | CH5_ERR_MOD_SAT | CH5_ERR_FILTER_SAT | CH5_ERR_OUTPUT_SAT | CH4_ERR_MOD_SAT | CH4_ERR_FILTER_SAT | CH4_ERR_OUTPUT_SAT | 0x00 | R |
| 0x057 | CH6_7_SAT_ERR | [7:0] | RESERVED | | CH7_ERR_MOD_SAT | CH7_ERR_FILTER_SAT | CH7_ERR_OUTPUT_SAT | CH6_ERR_MOD_SAT | CH6_ERR_FILTER_SAT | CH6_ERR_OUTPUT_SAT | 0x00 | R |
| 0x058 | CHX_ERR_REG_EN | [7:0] | OUTPUT_SAT_TEST_EN | FILTER_SAT_TEST_EN | MOD_SAT_TEST_EN | AINM_UV_TEST_EN | AINM_OV_TEST_EN | AINP_UV_TEST_EN | AINP_OV_TEST_EN | REF_DET_TEST_EN | 0xFE | R/W |
| 0x059 | GEN_ERR_REG_1 | [7:0] | RESERVED | | MEMMAP_CRC_ERR | ROM_CRC_ERR | SPI_CLK_COUNT_ERR | SPI_INVALID_READ_ERR | SPI_INVALID_WRITE_ERR | SPI_CRC_ERR | 0x00 | R |
| 0x05A | GEN_ERR_REG_1_EN | [7:0] | RESERVED | | MEMMAP_CRC_TEST_EN | ROM_CRC_TEST_EN | SPI_CLK_COUNT_TEST_EN | SPI_INVALID_READ_TEST_EN | SPI_INVALID_WRITE_TEST_EN | SPI_CRC_TEST_EN | 0x3E | R/W |
| 0x05B | GEN_ERR_REG_2 | [7:0] | RESERVED | | RESET_DETECTED | EXT_MCLK_SWITCH_ERR | RESERVED | ALDO1_PSM_ERR | ALDO2_PSM_ERR | DLDO_PSM_ERR | 0x00 | R |
| 0x05C | GEN_ERR_REG_2_EN | [7:0] | RESERVED | | RESET_DETECT_EN | RESERVED | LDO_PSM_TEST_EN | | LDO_PSM_TRIP_TEST_EN | | 0x3C | R/W |

| Reg. | Name | Bits | Bit 7 | Bit 6 | Bit 5 | Bit 4 | Bit 3 | Bit 2 | Bit 1 | Bit 0 | Reset | R/W | |
|-------|--------------|-------|------------------|----------|------------|---------------|-------------------|-------------------|-------------------|-------------------|-------|------|-----|
| 0x05D | STATUS_REG_1 | [7:0] | RESERVED | | CHIP_ERROR | ERR_LOC_CH4 | ERR_LOC_CH3 | ERR_LOC_CH2 | ERR_LOC_CH1 | ERR_LOC_CH0 | 0x00 | R | |
| 0x05E | STATUS_REG_2 | [7:0] | RESERVED | | CHIP_ERROR | ERR_LOC_GEN2 | ERR_LOC_GEN1 | ERR_LOC_CH7 | ERR_LOC_CH6 | ERR_LOC_CH5 | 0x00 | R | |
| 0x05F | STATUS_REG_3 | [7:0] | RESERVED | | CHIP_ERROR | INIT_COMPLETE | ERR_LOC_SAT_CH6_7 | ERR_LOC_SAT_CH4_5 | ERR_LOC_SAT_CH2_3 | ERR_LOC_SAT_CH0_1 | 0x00 | R | |
| 0x060 | SRC_N_MSB | [7:0] | RESERVED | | | | SRC_N_ALL[11:8] | | | | | 0x00 | R/W |
| 0x061 | SRC_N_LSB | [7:0] | SRC_N_ALL[7:0] | | | | | | | | | 0x80 | R/W |
| 0x062 | SRC_IF_MSB | [7:0] | SRC_IF_ALL[15:8] | | | | | | | | | 0x00 | R/W |
| 0x063 | SRC_IF_LSB | [7:0] | SRC_IF_ALL[7:0] | | | | | | | | | 0x00 | R/W |
| 0x064 | SRC_UPDATE | [7:0] | SRC_LOAD_SOURCE | RESERVED | | | | | | SRC_LOAD_UPDATE | 0x00 | R/W | |

REGISTER DETAILS

CHANNEL 0 CONFIGURATION REGISTER

Address: 0x000, Reset: 0x00, Name: CH0_CONFIG

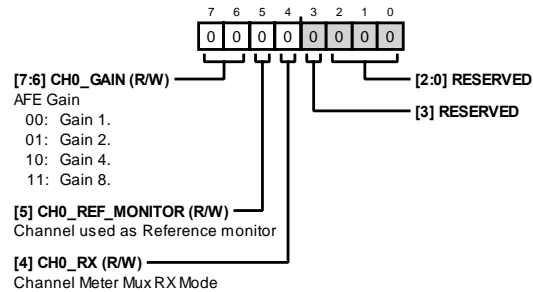

Table 44. Bit Descriptions for CH0_CONFIG

| Bits | Bit Name | Settings | Description | Reset | Access |
|-------|-----------------|----------------------|--|-------|--------|
| [7:6] | CH0_GAIN | 00 01 10 11 | AFE Gain Gain = 1 Gain = 2 Gain = 4 Gain = 8 | 0x0 | R/W |
| 5 | CH0_REF_MONITOR | | Channel Used as Reference Monitor | 0x0 | R/W |
| 4 | CH0_RX | | Channel Meter Mux Rx Mode | 0x0 | R/W |
| [3:0] | RESERVED | | Reserved | 0x0 | R/W |

CHANNEL 1 CONFIGURATION REGISTER

Address: 0x001, Reset: 0x00, Name: CH1_CONFIG

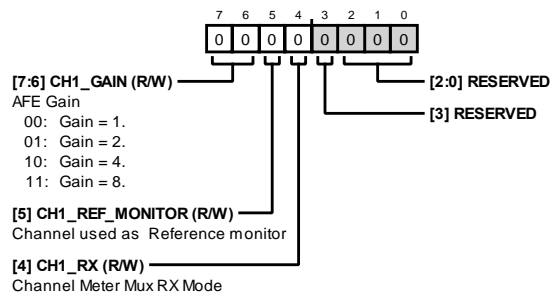

Table 45. Bit Descriptions for CH1_CONFIG

| Bits | Bit Name | Settings | Description | Reset | Access |
|-------|-----------------|----------------------|--|-------|--------|
| [7:6] | CH1_GAIN | 00 01 10 11 | AFE Gain Gain = 1 Gain = 2 Gain = 4 Gain = 8 | 0x0 | R/W |
| 5 | CH1_REF_MONITOR | | Channel Used as Reference Monitor | 0x0 | R/W |
| 4 | CH1_RX | | Channel Meter Mux Rx Mode | 0x0 | R/W |
| [3:0] | RESERVED | | Reserved | 0x0 | R/W |

CHANNEL 2 CONFIGURATION REGISTER

Address: 0x002, Reset: 0x00, Name: CH2_CONFIG

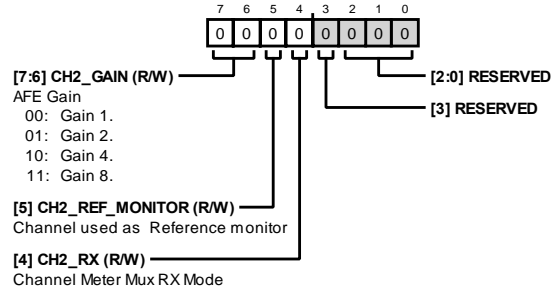

Table 46. Bit Descriptions for CH2_CONFIG

| Bits | Bit Name | Settings | Description | Reset | Access |
|-------|-----------------|----------------------|--|-------|--------|
| [7:6] | CH2_GAIN | 00 01 10 11 | AFE Gain Gain = 1 Gain = 2 Gain = 4 Gain = 8 | 0x0 | R/W |
| 5 | CH2_REF_MONITOR | | Channel Used as Reference Monitor | 0x0 | R/W |
| 4 | CH2_RX | | Channel Meter Mux Rx Mode | 0x0 | R/W |
| [3:0] | RESERVED | | Reserved | 0x0 | R/W |

CHANNEL 3 CONFIGURATION REGISTER

Address: 0x003, Reset: 0x00, Name: CH3_CONFIG

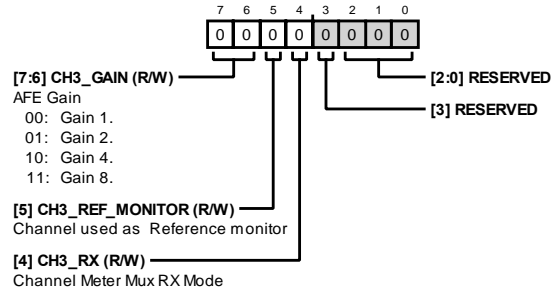

Table 47. Bit Descriptions for CH3_CONFIG

| Bits | Bit Name | Settings | Description | Reset | Access |
|-------|-----------------|----------------------|--|-------|--------|
| [7:6] | CH3_GAIN | 00 01 10 11 | AFE Gain Gain = 1 Gain = 2 Gain = 4 Gain = 8 | 0x0 | R/W |
| 5 | CH3_REF_MONITOR | | Channel Used as Reference Monitor | 0x0 | R/W |
| 4 | CH3_RX | | Channel Meter Mux Rx Mode | 0x0 | R/W |
| [3:0] | RESERVED | | Reserved | 0x0 | R/W |

CHANNEL 4 CONFIGURATION REGISTER

Address: 0x004, Reset: 0x00, Name: CH4_CONFIG

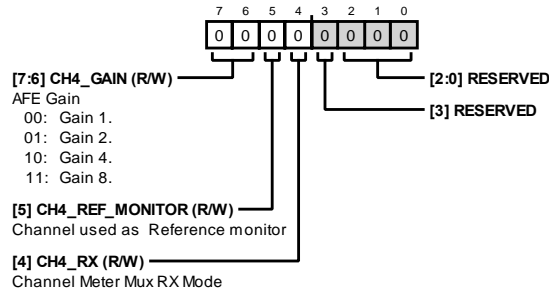

Table 48. Bit Descriptions for CH4_CONFIG

| Bits | Bit Name | Settings | Description | Reset | Access |
|-------|-----------------|----------------------|--|-------|--------|
| [7:6] | CH4_GAIN | 00 01 10 11 | AFE Gain Gain = 1 Gain = 2 Gain = 4 Gain = 8 | 0x0 | R/W |
| 5 | CH4_REF_MONITOR | | Channel Used as Reference Monitor | 0x0 | R/W |
| 4 | CH4_RX | | Channel Meter Mux Rx Mode | 0x0 | R/W |
| [3:0] | RESERVED | | Reserved | 0x0 | R/W |

CHANNEL 5 CONFIGURATION REGISTER

Address: 0x005, Reset: 0x00, Name: CH5_CONFIG

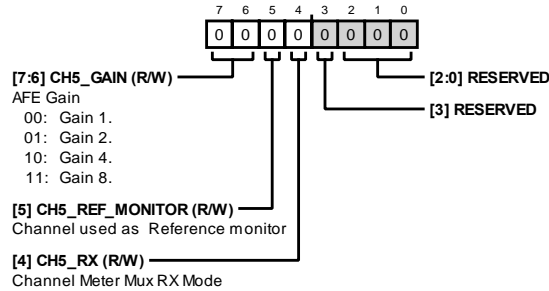

Table 49. Bit Descriptions for CH5_CONFIG

| Bits | Bit Name | Settings | Description | Reset | Access |
|-------|-----------------|----------------------|--|-------|--------|
| [7:6] | CH5_GAIN | 00 01 10 11 | AFE Gain Gain = 1 Gain = 2 Gain = 4 Gain = 8 | 0x0 | R/W |
| 5 | CH5_REF_MONITOR | | Channel Used as Reference Monitor | 0x0 | R/W |
| 4 | CH5_RX | | Channel Meter Mux Rx Mode | 0x0 | R/W |
| [3:0] | RESERVED | | Reserved | 0x0 | R/W |

CHANNEL 6 CONFIGURATION REGISTER

Address: 0x006, Reset: 0x00, Name: CH6_CONFIG

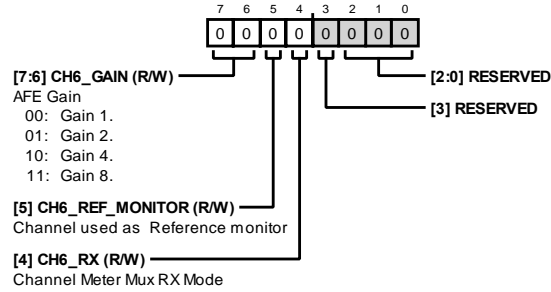

Table 50. Bit Descriptions for CH6_CONFIG

| Bits | Bit Name | Settings | Description | Reset | Access |
|-------|-----------------|----------------------|--|-------|--------|
| [7:6] | CH6_GAIN | 00 01 10 11 | AFE Gain Gain = 1 Gain = 2 Gain = 4 Gain = 8 | 0x0 | R/W |
| 5 | CH6_REF_MONITOR | | Channel Used as Reference Monitor | 0x0 | R/W |
| 4 | CH6_RX | | Channel Meter Mux Rx Mode | 0x0 | R/W |
| [3:0] | RESERVED | | Reserved | 0x0 | R/W |

CHANNEL 7 CONFIGURATION REGISTER

Address: 0x007, Reset: 0x00, Name: CH7_CONFIG

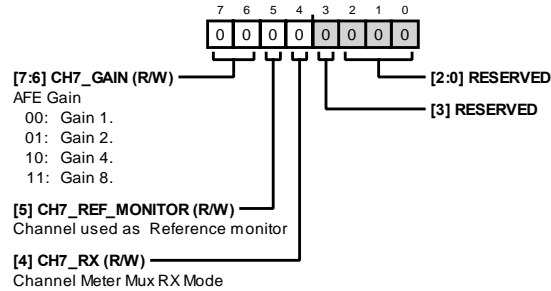

Table 51. Bit Descriptions for CH7_CONFIG

| Bits | Bit Name | Settings | Description | Reset | Access |
|-------|-----------------|----------------------|--|-------|--------|
| [7:6] | CH7_GAIN | 00 01 10 11 | AFE Gain Gain = 1 Gain = 2 Gain = 4 Gain = 8 | 0x0 | R/W |
| 5 | CH7_REF_MONITOR | | Channel Used as Reference Monitor | 0x0 | R/W |
| 4 | CH7_RX | | Channel Meter Mux Rx Mode | 0x0 | R/W |
| [3:0] | RESERVED | | Reserved | 0x0 | R/W |

DISABLE CLOCKS TO ADC CHANNEL REGISTER

Address: 0x008, Reset: 0x00, Name: CH_DISABLE

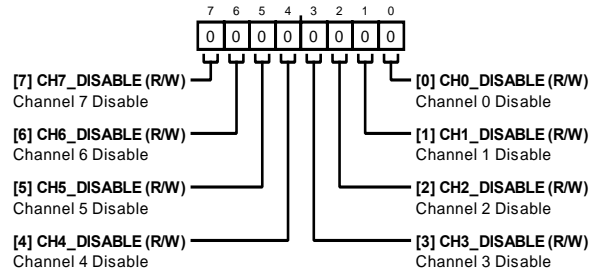

Table 52. Bit Descriptions for CH_DISABLE

| Bits | Bit Name | Settings | Description | Reset | Access |
|------|-------------|----------|-------------------|-------|--------|
| 7 | CH7_DISABLE | | Channel 7 Disable | 0x0 | R/W |
| 6 | CH6_DISABLE | | Channel 6 Disable | 0x0 | R/W |
| 5 | CH5_DISABLE | | Channel 5 Disable | 0x0 | R/W |
| 4 | CH4_DISABLE | | Channel 4 Disable | 0x0 | R/W |
| 3 | CH3_DISABLE | | Channel 3 Disable | 0x0 | R/W |
| 2 | CH2_DISABLE | | Channel 2 Disable | 0x0 | R/W |
| 1 | CH1_DISABLE | | Channel 1 Disable | 0x0 | R/W |
| 0 | CH0_DISABLE | | Channel 0 Disable | 0x0 | R/W |

CHANNEL 0 SYNC OFFSET REGISTER

Address: 0x009, Reset: 0x00, Name: CH0_SYNC_OFFSET

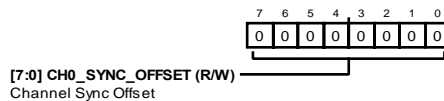

Table 53. Bit Descriptions for CH0_SYNC_OFFSET

| Bits | Bit Name | Settings | Description | Reset | Access |
|-------|-----------------|----------|---------------------|-------|--------|
| [7:0] | CH0_SYNC_OFFSET | | Channel Sync Offset | 0x0 | R/W |

CHANNEL 1 SYNC OFFSET REGISTER

Address: 0x00A, Reset: 0x00, Name: CH1_SYNC_OFFSET

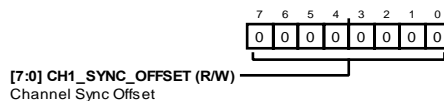

Table 54. Bit Descriptions for CH1_SYNC_OFFSET

| Bits | Bit Name | Settings | Description | Reset | Access |
|-------|-----------------|----------|---------------------|-------|--------|
| [7:0] | CH1_SYNC_OFFSET | | Channel Sync Offset | 0x0 | R/W |

CHANNEL 2 SYNC OFFSET REGISTER

Address: 0x00B, Reset: 0x00, Name: CH2_SYNC_OFFSET

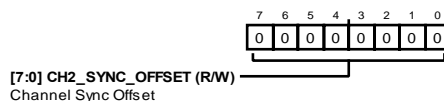

Table 55. Bit Descriptions for CH2_SYNC_OFFSET

| Bits | Bit Name | Settings | Description | Reset | Access |
|-------|-----------------|----------|---------------------|-------|--------|
| [7:0] | CH2_SYNC_OFFSET | | Channel Sync Offset | 0x0 | R/W |

CHANNEL 3 SYNC OFFSET REGISTER

Address: 0x00C, Reset: 0x00, Name: CH3_SYNC_OFFSET

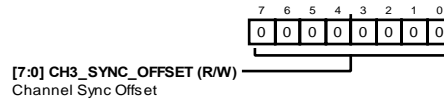

Table 56. Bit Descriptions for CH3_SYNC_OFFSET

| Bits | Bit Name | Settings | Description | Reset | Access |
|-------|-----------------|----------|---------------------|-------|--------|
| [7:0] | CH3_SYNC_OFFSET | | Channel Sync Offset | 0x0 | R/W |

CHANNEL 4 SYNC OFFSET REGISTER

Address: 0x00D, Reset: 0x00, Name: CH4_SYNC_OFFSET

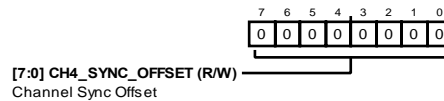

Table 57. Bit Descriptions for CH4_SYNC_OFFSET

| Bits | Bit Name | Settings | Description | Reset | Access |
|-------|-----------------|----------|---------------------|-------|--------|
| [7:0] | CH4_SYNC_OFFSET | | Channel Sync Offset | 0x0 | R/W |

CHANNEL 5 SYNC OFFSET REGISTER

Address: 0x00E, Reset: 0x00, Name: CH5_SYNC_OFFSET

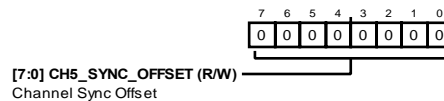

Table 58. Bit Descriptions for CH5_SYNC_OFFSET

| Bits | Bit Name | Settings | Description | Reset | Access |
|-------|-----------------|----------|---------------------|-------|--------|
| [7:0] | CH5_SYNC_OFFSET | | Channel Sync Offset | 0x0 | R/W |

CHANNEL 6 SYNC OFFSET REGISTER

Address: 0x00F, Reset: 0x00, Name: CH6_SYNC_OFFSET

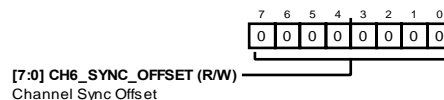

Table 59. Bit Descriptions for CH6_SYNC_OFFSET

| Bits | Bit Name | Settings | Description | Reset | Access |
|-------|-----------------|----------|---------------------|-------|--------|
| [7:0] | CH6_SYNC_OFFSET | | Channel Sync Offset | 0x0 | R/W |

CHANNEL 7 SYNC OFFSET REGISTER

Address: 0x010, Reset: 0x00, Name: CH7_SYNC_OFFSET

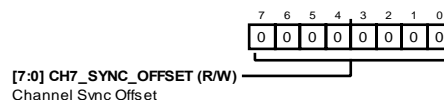

Table 60. Bit Descriptions for CH7_SYNC_OFFSET

| Bits | Bit Name | Settings | Description | Reset | Access |
|-------|-----------------|----------|---------------------|-------|--------|
| [7:0] | CH7_SYNC_OFFSET | | Channel Sync Offset | 0x0 | R/W |

GENERAL USER CONFIGURATION 1 REGISTER

Address: 0x011, Reset: 0x24, Name: GENERAL_USER_CONFIG_1

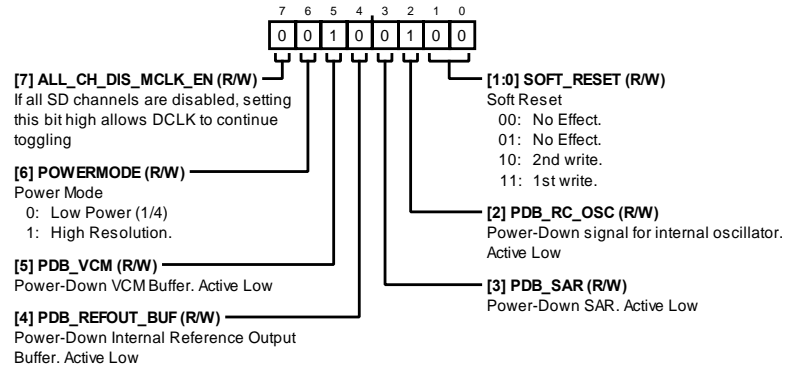

Table 61. Bit Descriptions for GENERAL_USER_CONFIG_1

| Bits | Bit Name | Settings | Description | Reset | Access |
|-------|--------------------|----------------------|---|-------|--------|
| 7 | ALL_CH_DIS_MCLK_EN | | If all Σ - Δ channels are disabled, setting this bit high allows DCLK to continue toggling. | 0x0 | R/W |
| 6 | POWERMODE | 0 1 | Power Mode. Low power (1/4). High resolution. | 0x0 | R/W |
| 5 | PDB_VCM | | Power-Down VCM Buffer. Active low. | 0x1 | R/W |
| 4 | PDB_REFOUT_BUF | | Power-Down Internal Reference Output Buffer. Active low. | 0x0 | R/W |
| 3 | PDB_SAR | | Power-Down SAR. Active low. | 0x0 | R/W |
| 2 | PDB_RC_OSC | | Power-Down Signal for Internal Oscillator. Active low. | 0x1 | R/W |
| [1:0] | SOFT_RESET | 00 01 10 11 | Soft Reset No effect No effect 2nd write 1st write | 0x0 | R/W |

GENERAL USER CONFIGURATION 2 REGISTER

Address: 0x012, Reset: 0x09, Name: GENERAL_USER_CONFIG_2

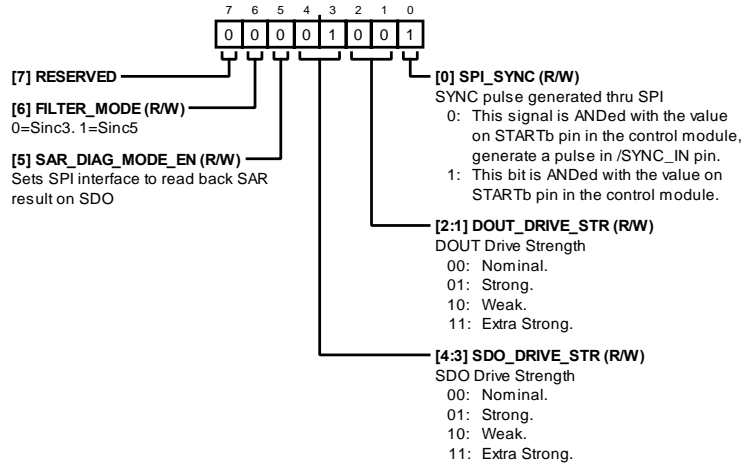

Table 62. Bit Descriptions for GENERAL_USER_CONFIG_2

| Bits | Bit Name | Settings | Description | Reset | Access |
|-------|------------------|----------------------|--|-------|--------|
| 7 | RESERVED | | Reserved. | 0x0 | R/W |
| 6 | FILTER_MODE | | 0 = Sinc3. 1 = Sinc5. | 0x0 | R/W |
| 5 | SAR_DIAG_MODE_EN | | Sets SPI interface to read back SAR result on SDO. | 0x0 | R/W |
| [4:3] | SDO_DRIVE_STR | 00 01 10 11 | SDO Drive Strength. Nominal. Strong. Weak. Extra Strong. | 0x1 | R/W |
| [2:1] | DOUT_DRIVE_STR | 00 01 10 11 | DOUTx Drive Strength. Nominal. Strong. Weak. Extra Strong. | 0x0 | R/W |
| 0 | SPI_SYNC | 0 1 | Sync pulse generated through SPI. This signal is AND'ed with the value on <u>START</u> pin in the control module to generate a pulse in <u>SYNC_IN</u> pin. This bit is AND'ed with the value on <u>START</u> pin in the control module. | 0x1 | R/W |

GENERAL USER CONFIGURATION 3 REGISTER

Address: 0x013, Reset: 0x80, Name: GENERAL_USER_CONFIG_3

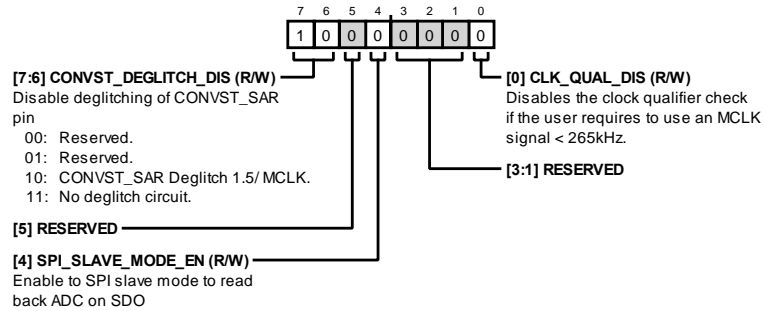

Table 63. Bit Descriptions for GENERAL_USER_CONFIG_3

| Bits | Bit Name | Settings | Description | Reset | Access |
|-------|---------------------|----------------------|---|-------|--------|
| [7:6] | CONVST_DEGLITCH_DIS | 00 01 10 11 | Disable deglitching of CONVST_SAR pin. Reserved. Reserved. CONVST_SAR deglitch 1.5/MCLK. No deglitch circuit. | 0x2 | R/W |
| 5 | RESERVED | | Reserved. | 0x0 | R/W |
| 4 | SPI_SLAVE_MODE_EN | | Enable to SPI slave mode to read back ADC on SDO. | 0x0 | R/W |
| [3:2] | RESERVED | | Reserved. | 0x0 | R/W |
| 1 | RESERVED | | Reserved. | 0x0 | R/W |
| 0 | CLK_QUAL_DIS | | Disables the clock qualifier check if the user requires to use an MCLK signal <265 kHz. | 0x0 | R/W |

DATA OUTPUT FORMAT REGISTER

Address: 0x014, Reset: 0x20, Name: DOUT_FORMAT

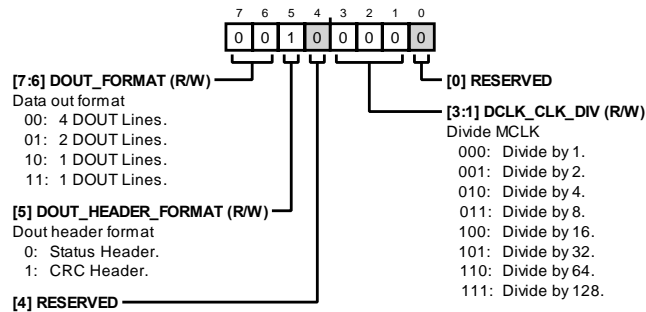

Table 64. Bit Descriptions for DOUT_FORMAT

| Bits | Bit Name | Settings | Description | Reset | Access |
|-------|--------------------|----------------------|--|-------|--------|
| [7:6] | DOUT_FORMAT | 00 01 10 11 | Data Out Format 4 DOUTx lines 2 DOUTx lines 1 DOUTx lines 1 DOUTx line | 0x0 | R/W |
| 5 | DOUT_HEADER_FORMAT | 0 1 | DOUTx Header Format Status header CRC header | 0x1 | R/W |
| 4 | RESERVED | | Reserved | 0x0 | R/W |

| Bits | Bit Name | Settings | Description | Reset | Access |
|-------|--------------|--|--|-------|--------|
| [3:1] | DCLK_CLK_DIV | 000 001 010 011 100 101 110 111 | Divide MCLK Divide by 1 Divide by 2 Divide by 4 Divide by 8 Divide by 16 Divide by 32 Divide by 64 Divide by 128 | 0x0 | R/W |
| 0 | RESERVED | | Reserved | 0x0 | R/W |

MAIN ADC METER AND REFERENCE MUX CONTROL REGISTER

Address: 0x015, Reset: 0x00, Name: ADC_MUX_CONFIG

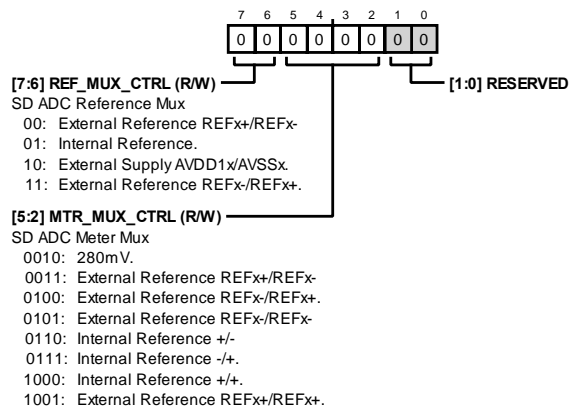

Table 65. Bit Descriptions for ADC_MUX_CONFIG

| Bits | Bit Name | Settings | Description | Reset | Access |
|-------|--------------|--|---|-------|--------|
| [7:6] | REF_MUX_CTRL | 00 01 10 11 | Σ - Δ ADC Reference Mux. External reference REF _{X+} /REF _{X-} . Internal reference. External supply AVDD1 _X /AVSS _X . External reference REF _{X-} /REF _{X+} . | 0x0 | R/W |
| [5:2] | MTR_MUX_CTRL | 0010 0011 0100 0101 0110 0111 1000 1001 | Σ - Δ ADC Meter Mux. 280 mV. External reference REF _{X+} /REF _{X-} . External reference REF _{X-} /REF _{X+} . External reference REF _{X-} /REF _{X-} . Internal reference +/- Internal reference -/+ Internal reference +/- External reference REF _{X+} /REF _{X+} . | 0x0 | R/W |
| [1:0] | RESERVED | | Reserved. | 0x0 | R/W |

GLOBAL DIAGNOSTICS MUX REGISTER

Address: 0x016, Reset: 0x00, Name: GLOBAL_MUX_CONFIG

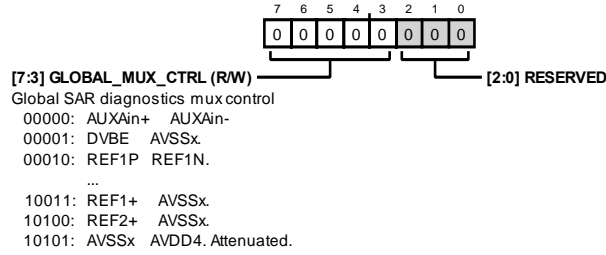

Table 66. Bit Descriptions for GLOBAL_MUX_CONFIG

| Bits | Bit Name | Settings | Description | Reset | Access |
|-------|-----------------|----------|-------------------------------------|-------|--------|
| [7:3] | GLOBAL_MUX_CTRL | | Global SAR Diagnostics Mux Control. | 0x0 | R/W |
| | | 00000 | AUXAIN+/AUXAIN-. | | |
| | | 00001 | DVBE/AVSSx. | | |
| | | 00010 | REF1+/REF1-. | | |
| | | 10011 | REF2+/REF2-. | | |
| | | 10100 | REF_OUT/AVSSx. | | |
| | | 10101 | VCM/AVSSx. | | |
| | | 10110 | AREG1CAP/AVSSx. | | |
| | | 10111 | AREG2CAP/AVSSx. | | |
| | | 11000 | DREGCAP/DGND. | | |
| | | 11001 | AVDD1A/AVSSx. | | |
| | | 11010 | AVDD1B/AVSSx. | | |
| | | 11011 | AVDD2A/AVSSx. | | |
| | | 11100 | AVDD2B/AVSSx. | | |
| | | 11101 | IOVDD/DGND. | | |
| | | 11110 | AVDD4/AVSSx. | | |
| | | 11111 | DGND/AVSSx. | | |
| | | 10000 | DGND/AVSSx. | | |
| | | 10001 | DGND/AVSSx. | | |
| | | 10010 | AVDD4/AVSSx. | | |
| | | 10011 | REF1+/AVSSx. | | |
| | | 10100 | REF2+/AVSSx. | | |
| | | 10101 | AVSSx/AVDD4. Attenuated. | | |
| [2:0] | RESERVED | | Reserved. | 0x0 | R/W |

GPIO CONFIGURATION REGISTER

Address: 0x017, Reset: 0x00, Name: GPIO_CONFIG

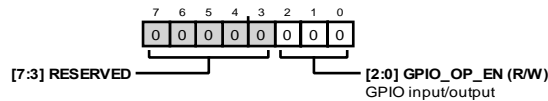

Table 67. Bit Descriptions for GPIO_CONFIG

| Bits | Bit Name | Settings | Description | Reset | Access |
|-------|------------|----------|-------------------|-------|--------|
| [7:3] | RESERVED | | Reserved. | 0x0 | R/W |
| [2:0] | GPIO_OP_EN | | GPIO Input/Output | 0x0 | R/W |

GPIO DATA REGISTER

Address: 0x018, Reset: 0x00, Name: GPIO_DATA

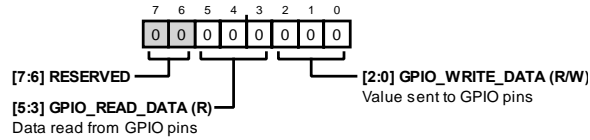

Table 68. Bit Descriptions for GPIO_DATA

| Bits | Bit Name | Settings | Description | Reset | Access |
|-------|-----------------|----------|------------------------------|-------|--------|
| [7:6] | RESERVED | | Reserved. | 0x0 | R/W |
| [5:3] | GPIO_READ_DATA | | Data Read from the GPIO Pins | 0x0 | R |
| [2:0] | GPIO_WRITE_DATA | | Value Sent to the GPIO Pins | 0x0 | R/W |

BUFFER CONFIGURATION 1 REGISTER

Address: 0x019, Reset: 0x38, Name: BUFFER_CONFIG_1

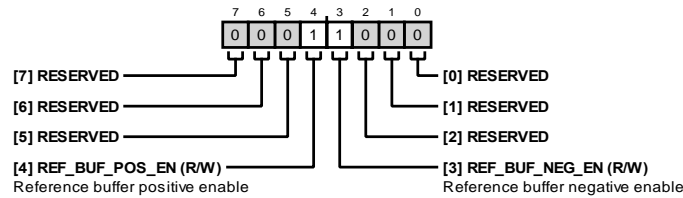

Table 69. Bit Descriptions for BUFFER_CONFIG_1

| Bits | Bit Name | Settings | Description | Reset | Access |
|-------|----------------|----------|----------------------------------|-------|--------|
| [7:5] | RESERVED | | Reserved | 0x0 | R/W |
| 4 | REF_BUF_POS_EN | | Reference Buffer Positive Enable | 0x1 | R/W |
| 3 | REF_BUF_NEG_EN | | Reference Buffer Negative Enable | 0x1 | R/W |
| [2:0] | RESERVED | | Reserved | 0x0 | R/W |

BUFFER CONFIGURATION 2 REGISTER

Address: 0x01A, Reset: 0xC0, Name: BUFFER_CONFIG_2

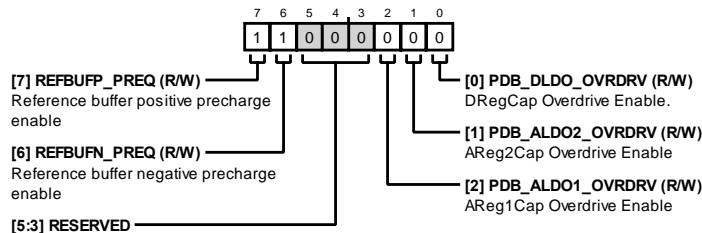

Table 70. Bit Descriptions for BUFFER_CONFIG_2

| Bits | Bit Name | Settings | Description | Reset | Access |
|-------|------------------|----------|--|-------|--------|
| 7 | REFBUFF_PREQ | | Reference Buffer Positive Precharge Enable | 0x1 | R/W |
| 6 | REFBUFN_PREQ | | Reference Buffer Negative Precharge Enable | 0x1 | R/W |
| [5:3] | RESERVED | | Reserved | 0x0 | R/W |
| 2 | PDB_ALDO1_OVRDRV | | AREG1CAP Overdrive Enable | 0x0 | R/W |
| 1 | PDB_ALDO2_OVRDRV | | AREG2CAP Overdrive Enable | 0x0 | R/W |
| 0 | PDB_DLDO_OVRDRV | | DREGCAP Overdrive Enable | 0x0 | R/W |

CHANNEL 0 OFFSET UPPER BYTE REGISTER

Address: 0x01C, Reset: 0x00, Name: CH0_OFFSET_UPPER_BYTE

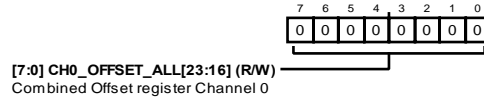

Table 71. Bit Descriptions for CH0_OFFSET_UPPER_BYTE

| Bits | Bit Name | Settings | Description | Reset | Access |
|-------|-----------------------|----------|------------------------------------|-------|--------|
| [7:0] | CH0_OFFSET_ALL[23:16] | | Combined Offset Register Channel 0 | 0x0 | R/W |

CHANNEL 0 OFFSET MIDDLE BYTE REGISTER

Address: 0x01D, Reset: 0x00, Name: CH0_OFFSET_MID_BYTE

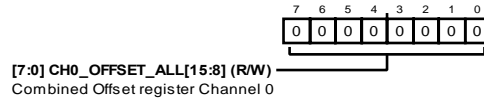

Table 72. Bit Descriptions for CH0_OFFSET_MID_BYTE

| Bits | Bit Name | Settings | Description | Reset | Access |
|-------|----------------------|----------|------------------------------------|-------|--------|
| [7:0] | CH0_OFFSET_ALL[15:8] | | Combined Offset Register Channel 0 | 0x0 | R/W |

CHANNEL 0 OFFSET LOWER BYTE REGISTER

Address: 0x01E, Reset: 0x00, Name: CH0_OFFSET_LOWER_BYTE

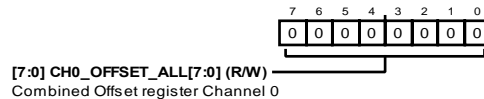

Table 73. Bit Descriptions for CH0_OFFSET_LOWER_BYTE

| Bits | Bit Name | Settings | Description | Reset | Access |
|-------|---------------------|----------|------------------------------------|-------|--------|
| [7:0] | CH0_OFFSET_ALL[7:0] | | Combined Offset Register Channel 0 | 0x0 | R/W |

CHANNEL 0 GAIN UPPER BYTE REGISTER

Address: 0x01F, Reset: 0x00, Name: CH0_GAIN_UPPER_BYTE

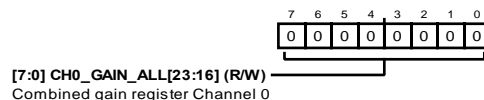

Table 74. Bit Descriptions for CH0_GAIN_UPPER_BYTE

| Bits | Bit Name | Settings | Description | Reset | Access |
|-------|---------------------|----------|----------------------------------|-------|--------|
| [7:0] | CH0_GAIN_ALL[23:16] | | Combined Gain Register Channel 0 | 0x0 | R/W |

CHANNEL 0 GAIN MIDDLE BYTE REGISTER

Address: 0x020, Reset: 0x00, Name: CH0_GAIN_MID_BYTE

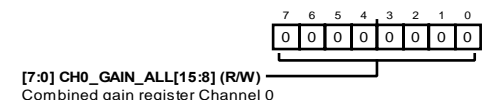

Table 75. Bit Descriptions for CH0_GAIN_MID_BYTE

| Bits | Bit Name | Settings | Description | Reset | Access |
|-------|--------------------|----------|----------------------------------|-------|--------|
| [7:0] | CH0_GAIN_ALL[15:8] | | Combined Gain Register Channel 0 | 0x0 | R/W |

CHANNEL 0 GAIN LOWER BYTE REGISTER

Address: 0x021, Reset: 0x00, Name: CH0_GAIN_LOWER_BYTE

[7:0] CH0_GAIN_ALL[7:0] (R/W)
Combined gain register Channel 0

Table 76. Bit Descriptions for CH0_GAIN_LOWER_BYTE

| Bits | Bit Name | Settings | Description | Reset | Access |
|-------|-------------------|----------|----------------------------------|-------|--------|
| [7:0] | CH0_GAIN_ALL[7:0] | | Combined Gain Register Channel 0 | 0x0 | R/W |

CHANNEL 1 OFFSET UPPER BYTE REGISTER

Address: 0x022, Reset: 0x00, Name: CH1_OFFSET_UPPER_BYTE

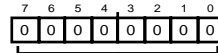
[7:0] CH1_OFFSET_ALL[23:16] (R/W)
Combined offset register Channel 1

Table 77. Bit Descriptions for CH1_OFFSET_UPPER_BYTE

| Bits | Bit Name | Settings | Description | Reset | Access |
|-------|-----------------------|----------|------------------------------------|-------|--------|
| [7:0] | CH1_OFFSET_ALL[23:16] | | Combined Offset Register Channel 1 | 0x0 | R/W |

CHANNEL 1 OFFSET MIDDLE BYTE REGISTER

Address: 0x023, Reset: 0x00, Name: CH1_OFFSET_MID_BYTE

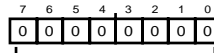
[7:0] CH1_OFFSET_ALL[15:8] (R/W)
Combined offset register Channel 1

Table 78. Bit Descriptions for CH1_OFFSET_MID_BYTE

| Bits | Bit Name | Settings | Description | Reset | Access |
|-------|----------------------|----------|------------------------------------|-------|--------|
| [7:0] | CH1_OFFSET_ALL[15:8] | | Combined Offset Register Channel 1 | 0x0 | R/W |

CHANNEL 1 OFFSET LOWER BYTE REGISTER

Address: 0x024, Reset: 0x00, Name: CH1_OFFSET_LOWER_BYTE

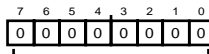
[7:0] CH1_OFFSET_ALL[7:0] (R/W)
Combined offset register Channel 1

Table 79. Bit Descriptions for CH1_OFFSET_LOWER_BYTE

| Bits | Bit Name | Settings | Description | Reset | Access |
|-------|---------------------|----------|------------------------------------|-------|--------|
| [7:0] | CH1_OFFSET_ALL[7:0] | | Combined Offset Register Channel 1 | 0x0 | R/W |

CHANNEL 1 GAIN UPPER BYTE REGISTER

Address: 0x025, Reset: 0x00, Name: CH1_GAIN_UPPER_BYTE

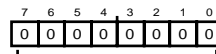
[7:0] CH1_GAIN_ALL[23:16] (R/W)
Combined gain register Channel 1

Table 80. Bit Descriptions for CH1_GAIN_UPPER_BYTE

| Bits | Bit Name | Settings | Description | Reset | Access |
|-------|---------------------|----------|----------------------------------|-------|--------|
| [7:0] | CH1_GAIN_ALL[23:16] | | Combined Gain Register Channel 1 | 0x0 | R/W |

CHANNEL 1 GAIN MIDDLE BYTE REGISTER

Address: 0x026, Reset: 0x00, Name: CH1_GAIN_MID_BYTE

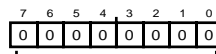
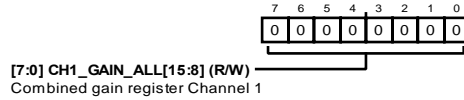

Table 81. Bit Descriptions for CH1_GAIN_MID_BYTE

| Bits | Bit Name | Settings | Description | Reset | Access |
|-------|--------------------|----------|----------------------------------|-------|--------|
| [7:0] | CH1_GAIN_ALL[15:8] | | Combined Gain Register Channel 1 | 0x0 | R/W |

CHANNEL 1 GAIN LOWER BYTE REGISTER

Address: 0x027, Reset: 0x00, Name: CH1_GAIN_LOWER_BYTE

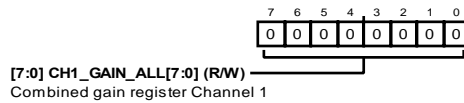

Table 82. Bit Descriptions for CH1_GAIN_LOWER_BYTE

| Bits | Bit Name | Settings | Description | Reset | Access |
|-------|-------------------|----------|----------------------------------|-------|--------|
| [7:0] | CH1_GAIN_ALL[7:0] | | Combined Gain Register Channel 1 | 0x0 | R/W |

CHANNEL 2 OFFSET UPPER BYTE REGISTER

Address: 0x028, Reset: 0x00, Name: CH2_OFFSET_UPPER_BYTE

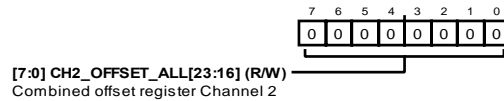

Table 83. Bit Descriptions for CH2_OFFSET_UPPER_BYTE

| Bits | Bit Name | Settings | Description | Reset | Access |
|-------|-----------------------|----------|------------------------------------|-------|--------|
| [7:0] | CH2_OFFSET_ALL[23:16] | | Combined Offset Register Channel 2 | 0x0 | R/W |

CHANNEL 2 OFFSET MIDDLE BYTE REGISTER

Address: 0x029, Reset: 0x00, Name: CH2_OFFSET_MID_BYTE

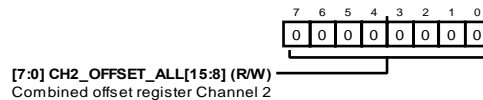

Table 84. Bit Descriptions for CH2_OFFSET_MID_BYTE

| Bits | Bit Name | Settings | Description | Reset | Access |
|-------|----------------------|----------|------------------------------------|-------|--------|
| [7:0] | CH2_OFFSET_ALL[15:8] | | Combined Offset Register Channel 2 | 0x0 | R/W |

CHANNEL 2 OFFSET LOWER BYTE REGISTER

Address: 0x02A, Reset: 0x00, Name: CH2_OFFSET_LOWER_BYTE

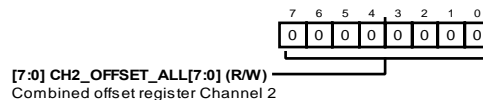

Table 85. Bit Descriptions for CH2_OFFSET_LOWER_BYTE

| Bits | Bit Name | Settings | Description | Reset | Access |
|-------|---------------------|----------|------------------------------------|-------|--------|
| [7:0] | CH2_OFFSET_ALL[7:0] | | Combined Offset Register Channel 2 | 0x0 | R/W |

CHANNEL 2 GAIN UPPER BYTE REGISTER

Address: 0x02B, Reset: 0x00, Name: CH2_GAIN_UPPER_BYTE

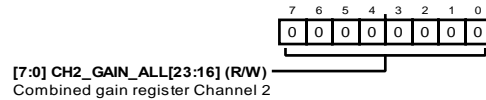

Table 86. Bit Descriptions for CH2_GAIN_UPPER_BYTE

| Bits | Bit Name | Settings | Description | Reset | Access |
|-------|---------------------|----------|----------------------------------|-------|--------|
| [7:0] | CH2_GAIN_ALL[23:16] | | Combined Gain Register Channel 2 | 0x0 | R/W |

CHANNEL 2 GAIN MIDDLE BYTE REGISTER

Address: 0x02C, Reset: 0x00, Name: CH2_GAIN_MID_BYTE

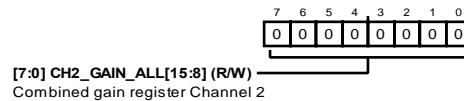

Table 87. Bit Descriptions for CH2_GAIN_MID_BYTE

| Bits | Bit Name | Settings | Description | Reset | Access |
|-------|--------------------|----------|----------------------------------|-------|--------|
| [7:0] | CH2_GAIN_ALL[15:8] | | Combined Gain Register Channel 2 | 0x0 | R/W |

CHANNEL 2 GAIN LOWER BYTE REGISTER

Address: 0x02D, Reset: 0x00, Name: CH2_GAIN_LOWER_BYTE

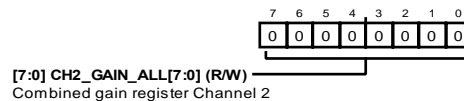

Table 88. Bit Descriptions for CH2_GAIN_LOWER_BYTE

| Bits | Bit Name | Settings | Description | Reset | Access |
|-------|-------------------|----------|----------------------------------|-------|--------|
| [7:0] | CH2_GAIN_ALL[7:0] | | Combined Gain Register Channel 2 | 0x0 | R/W |

CHANNEL 3 OFFSET UPPER BYTE REGISTER

Address: 0x02E, Reset: 0x00, Name: CH3_OFFSET_UPPER_BYTE



Table 89. Bit descriptions for CH3_OFFSET_UPPER_BYTE

| Bits | Bit Name | Settings | Description | Reset | Access |
|-------|-----------------------|----------|------------------------------------|-------|--------|
| [7:0] | CH3_OFFSET_ALL[23:16] | | Combined Offset Register Channel 3 | 0x0 | R/W |

CHANNEL 3 OFFSET MIDDLE BYTE REGISTER

Address: 0x02F, Reset: 0x00, Name: CH3_OFFSET_MID_BYTE

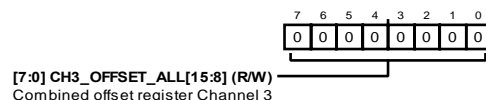

Table 90. Bit Descriptions for CH3_OFFSET_MID_BYTE

| Bits | Bit Name | Settings | Description | Reset | Access |
|-------|----------------------|----------|------------------------------------|-------|--------|
| [7:0] | CH3_OFFSET_ALL[15:8] | | Combined Offset Register Channel 3 | 0x0 | R/W |

CHANNEL 3 OFFSET LOWER BYTE REGISTER

Address: 0x030, Reset: 0x00, Name: CH3_OFFSET_LOWER_BYTE

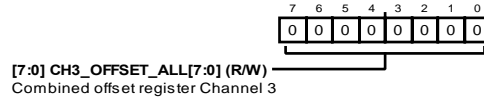

Table 91. Bit Descriptions for CH3_OFFSET_LOWER_BYTE

| Bits | Bit Name | Settings | Description | Reset | Access |
|-------|---------------------|----------|------------------------------------|-------|--------|
| [7:0] | CH3_OFFSET_ALL[7:0] | | Combined Offset Register Channel 3 | 0x0 | R/W |

CHANNEL 3 GAIN UPPER BYTE REGISTER

Address: 0x031, Reset: 0x00, Name: CH3_GAIN_UPPER_BYTE

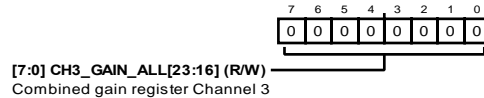

Table 92. Bit Descriptions for CH3_GAIN_UPPER_BYTE

| Bits | Bit Name | Settings | Description | Reset | Access |
|-------|---------------------|----------|----------------------------------|-------|--------|
| [7:0] | CH3_GAIN_ALL[23:16] | | Combined Gain Register Channel 3 | 0x0 | R/W |

CHANNEL 3 GAIN MIDDLE BYTE REGISTER

Address: 0x032, Reset: 0x00, Name: CH3_GAIN_MID_BYTE

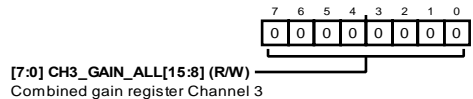

Table 93. Bit Descriptions for CH3_GAIN_MID_BYTE

| Bits | Bit Name | Settings | Description | Reset | Access |
|-------|--------------------|----------|----------------------------------|-------|--------|
| [7:0] | CH3_GAIN_ALL[15:8] | | Combined Gain Register Channel 3 | 0x0 | R/W |

CHANNEL 3 GAIN LOWER BYTE REGISTER

Address: 0x033, Reset: 0x00, Name: CH3_GAIN_LOWER_BYTE

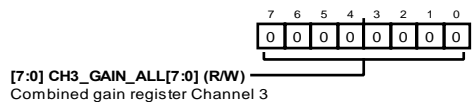

Table 94. Bit Descriptions for CH3_GAIN_LOWER_BYTE

| Bits | Bit Name | Settings | Description | Reset | Access |
|-------|-------------------|----------|----------------------------------|-------|--------|
| [7:0] | CH3_GAIN_ALL[7:0] | | Combined Gain Register Channel 3 | 0x0 | R/W |

CHANNEL 4 OFFSET UPPER BYTE REGISTER

Address: 0x034, Reset: 0x00, Name: CH4_OFFSET_UPPER_BYTE

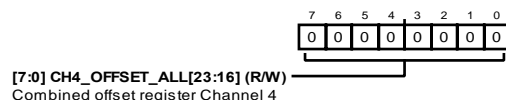

Table 95. Bit Descriptions for CH4_OFFSET_UPPER_BYTE

| Bits | Bit Name | Settings | Description | Reset | Access |
|-------|-----------------------|----------|------------------------------------|-------|--------|
| [7:0] | CH4_OFFSET_ALL[23:16] | | Combined Offset Register Channel 4 | 0x0 | R/W |

CHANNEL 4 OFFSET MIDDLE BYTE REGISTER

Address: 0x035, Reset: 0x00, Name: CH4_OFFSET_MID_BYTE

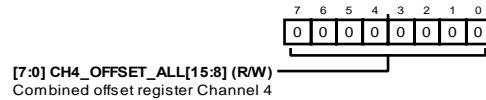

Table 96. Bit Descriptions for CH4_OFFSET_MID_BYTE

| Bits | Bit Name | Settings | Description | Reset | Access |
|-------|----------------------|----------|------------------------------------|-------|--------|
| [7:0] | CH4_OFFSET_ALL[15:8] | | Combined Offset Register Channel 4 | 0x0 | R/W |

CHANNEL 4 OFFSET LOWER BYTE REGISTER

Address: 0x036, Reset: 0x00, Name: CH4_OFFSET_LOWER_BYTE

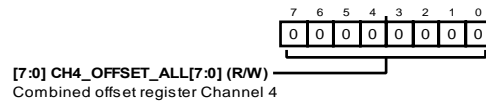

Table 97. Bit Descriptions for CH4_OFFSET_LOWER_BYTE

| Bits | Bit Name | Settings | Description | Reset | Access |
|-------|---------------------|----------|------------------------------------|-------|--------|
| [7:0] | CH4_OFFSET_ALL[7:0] | | Combined Offset Register Channel 4 | 0x0 | R/W |

CHANNEL 4 GAIN UPPER BYTE REGISTER

Address: 0x037, Reset: 0x00, Name: CH4_GAIN_UPPER_BYTE

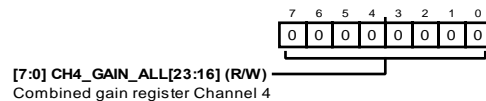

Table 98. Bit Descriptions for CH4_GAIN_UPPER_BYTE

| Bits | Bit Name | Settings | Description | Reset | Access |
|-------|---------------------|----------|----------------------------------|-------|--------|
| [7:0] | CH4_GAIN_ALL[23:16] | | Combined Gain Register Channel 4 | 0x0 | R/W |

CHANNEL 4 GAIN MIDDLE BYTE REGISTER

Address: 0x038, Reset: 0x00, Name: CH4_GAIN_MID_BYTE

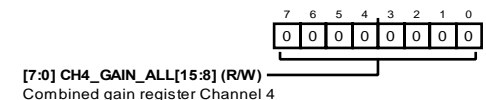

Table 99. Bit Descriptions for CH4_GAIN_MID_BYTE

| Bits | Bit Name | Settings | Description | Reset | Access |
|-------|--------------------|----------|----------------------------------|-------|--------|
| [7:0] | CH4_GAIN_ALL[15:8] | | Combined Gain Register Channel 4 | 0x0 | R/W |

CHANNEL 4 GAIN LOWER BYTE REGISTER

Address: 0x039, Reset: 0x00, Name: CH4_GAIN_LOWER_BYTE

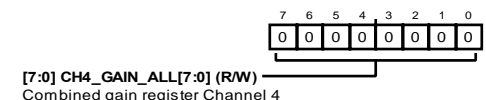

Table 100. Bit Descriptions for CH4_GAIN_LOWER_BYTE

| Bits | Bit Name | Settings | Description | Reset | Access |
|-------|-------------------|----------|----------------------------------|-------|--------|
| [7:0] | CH4_GAIN_ALL[7:0] | | Combined Gain Register Channel 4 | 0x0 | R/W |

CHANNEL 5 OFFSET UPPER BYTE REGISTER

Address: 0x03A, Reset: 0x00, Name: CH5_OFFSET_UPPER_BYTE



Table 101. Bit Descriptions for CH5_OFFSET_UPPER_BYTE

| Bits | Bit Name | Settings | Description | Reset | Access |
|-------|-----------------------|----------|------------------------------------|-------|--------|
| [7:0] | CH5_OFFSET_ALL[23:16] | | Combined Offset Register Channel 5 | 0x0 | R/W |

CHANNEL 5 OFFSET MIDDLE BYTE REGISTER

Address: 0x03B, Reset: 0x00, Name: CH5_OFFSET_MID_BYTE

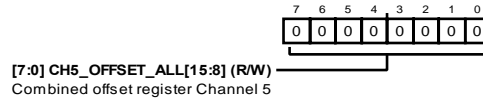

Table 102. Bit Descriptions for CH5_OFFSET_MID_BYTE

| Bits | Bit Name | Settings | Description | Reset | Access |
|-------|----------------------|----------|------------------------------------|-------|--------|
| [7:0] | CH5_OFFSET_ALL[15:8] | | Combined Offset Register Channel 5 | 0x0 | R/W |

CHANNEL 5 OFFSET LOWER BYTE REGISTER

Address: 0x03C, Reset: 0x00, Name: CH5_OFFSET_LOWER_BYTE

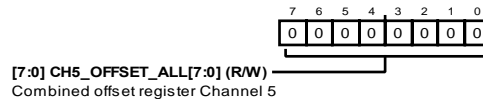

Table 103. Bit Descriptions for CH5_OFFSET_LOWER_BYTE

| Bits | Bit Name | Settings | Description | Reset | Access |
|-------|---------------------|----------|------------------------------------|-------|--------|
| [7:0] | CH5_OFFSET_ALL[7:0] | | Combined Offset Register Channel 5 | 0x0 | R/W |

CHANNEL 5 GAIN UPPER BYTE REGISTER

Address: 0x03D, Reset: 0x00, Name: CH5_GAIN_UPPER_BYTE

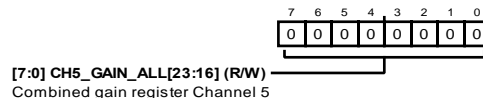

Table 104. Bit Descriptions for CH5_GAIN_UPPER_BYTE

| Bits | Bit Name | Settings | Description | Reset | Access |
|-------|---------------------|----------|----------------------------------|-------|--------|
| [7:0] | CH5_GAIN_ALL[23:16] | | Combined Gain Register Channel 5 | 0x0 | R/W |

CHANNEL 5 GAIN MIDDLE BYTE REGISTER

Address: 0x03E, Reset: 0x00, Name: CH5_GAIN_MID_BYTE

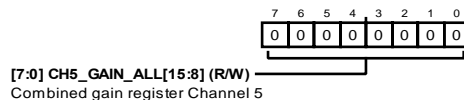

Table 105. Bit Descriptions for CH5_GAIN_MID_BYTE

| Bits | Bit Name | Settings | Description | Reset | Access |
|-------|--------------------|----------|----------------------------------|-------|--------|
| [7:0] | CH5_GAIN_ALL[15:8] | | Combined Gain Register Channel 5 | 0x0 | R/W |

CHANNEL 5 GAIN LOWER BYTE REGISTER

Address: 0x03F, Reset: 0x00, Name: CH5_GAIN_LOWER_BYTE

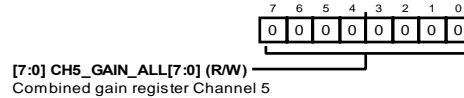

Table 106. Bit Descriptions for CH5_GAIN_LOWER_BYTE

| Bits | Bit Name | Settings | Description | Reset | Access |
|-------|-------------------|----------|----------------------------------|-------|--------|
| [7:0] | CH5_GAIN_ALL[7:0] | | Combined Gain Register Channel 5 | 0x0 | R/W |

CHANNEL 6 OFFSET UPPER BYTE REGISTER

Address: 0x040, Reset: 0x00, Name: CH6_OFFSET_UPPER_BYTE



Table 107. Bit Descriptions for CH6_OFFSET_UPPER_BYTE

| Bits | Bit Name | Settings | Description | Reset | Access |
|-------|-----------------------|----------|------------------------------------|-------|--------|
| [7:0] | CH6_OFFSET_ALL[23:16] | | Combined Offset Register Channel 6 | 0x0 | R/W |

CHANNEL 6 OFFSET MIDDLE BYTE REGISTER

Address: 0x041, Reset: 0x00, Name: CH6_OFFSET_MID_BYTE

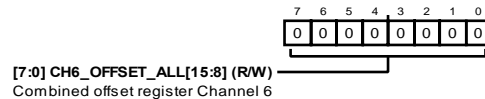

Table 108. Bit Descriptions for CH6_OFFSET_MID_BYTE

| Bits | Bit Name | Settings | Description | Reset | Access |
|-------|----------------------|----------|------------------------------------|-------|--------|
| [7:0] | CH6_OFFSET_ALL[15:8] | | Combined Offset Register Channel 6 | 0x0 | R/W |

CHANNEL 6 OFFSET LOWER BYTE REGISTER

Address: 0x042, Reset: 0x00, Name: CH6_OFFSET_LOWER_BYTE

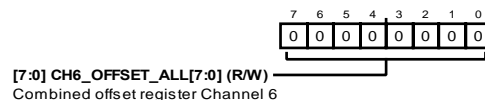

Table 109. Bit Descriptions for CH6_OFFSET_LOWER_BYTE

| Bits | Bit Name | Settings | Description | Reset | Access |
|-------|---------------------|----------|------------------------------------|-------|--------|
| [7:0] | CH6_OFFSET_ALL[7:0] | | Combined Offset Register Channel 6 | 0x0 | R/W |

CHANNEL 6 GAIN UPPER BYTE REGISTER

Address: 0x043, Reset: 0x00, Name: CH6_GAIN_UPPER_BYTE

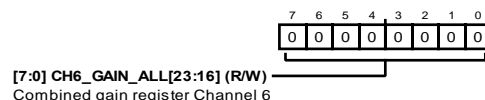

Table 110. Bit Descriptions for CH6_GAIN_UPPER_BYTE

| Bits | Bit Name | Settings | Description | Reset | Access |
|-------|---------------------|----------|----------------------------------|-------|--------|
| [7:0] | CH6_GAIN_ALL[23:16] | | Combined Gain Register Channel 6 | 0x0 | R/W |

CHANNEL 6 GAIN MIDDLE BYTE REGISTER

Address: 0x044, Reset: 0x00, Name: CH6_GAIN_MID_BYTE

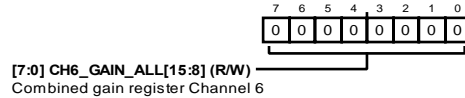

Table 111. Bit Descriptions for CH6_GAIN_MID_BYTE

| Bits | Bit Name | Settings | Description | Reset | Access |
|-------|--------------------|----------|----------------------------------|-------|--------|
| [7:0] | CH6_GAIN_ALL[15:8] | | Combined Gain Register Channel 6 | 0x0 | R/W |

CHANNEL 6 GAIN LOWER BYTE REGISTER

Address: 0x045, Reset: 0x00, Name: CH6_GAIN_LOWER_BYTE

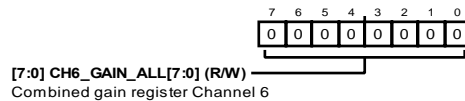

Table 112. Bit Descriptions for CH6_GAIN_LOWER_BYTE

| Bits | Bit Name | Settings | Description | Reset | Access |
|-------|-------------------|----------|----------------------------------|-------|--------|
| [7:0] | CH6_GAIN_ALL[7:0] | | Combined Gain Register Channel 6 | 0x0 | R/W |

CHANNEL 7 OFFSET UPPER BYTE REGISTER

Address: 0x046, Reset: 0x00, Name: CH7_OFFSET_UPPER_BYTE



Table 113. Bit Descriptions for CH7_OFFSET_UPPER_BYTE

| Bits | Bit Name | Settings | Description | Reset | Access |
|-------|-----------------------|----------|------------------------------------|-------|--------|
| [7:0] | CH7_OFFSET_ALL[23:16] | | Combined Offset Register Channel 7 | 0x0 | R/W |

CHANNEL 7 OFFSET MIDDLE BYTE REGISTER

Address: 0x047, Reset: 0x00, Name: CH7_OFFSET_MID_BYTE

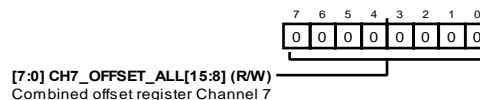

Table 114. Bit Descriptions for CH7_OFFSET_MID_BYTE

| Bits | Bit Name | Settings | Description | Reset | Access |
|-------|----------------------|----------|------------------------------------|-------|--------|
| [7:0] | CH7_OFFSET_ALL[15:8] | | Combined Offset Register Channel 7 | 0x0 | R/W |

CHANNEL 7 OFFSET LOWER BYTE REGISTER

Address: 0x048, Reset: 0x00, Name: CH7_OFFSET_LOWER_BYTE

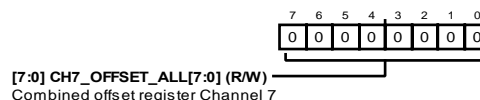

Table 115. Bit Descriptions for CH7_OFFSET_LOWER_BYTE

| Bits | Bit Name | Settings | Description | Reset | Access |
|-------|---------------------|----------|------------------------------------|-------|--------|
| [7:0] | CH7_OFFSET_ALL[7:0] | | Combined Offset Register Channel 7 | 0x0 | R/W |

CHANNEL 7 GAIN UPPER BYTE REGISTER

Address: 0x049, Reset: 0x00, Name: CH7_GAIN_UPPER_BYTE

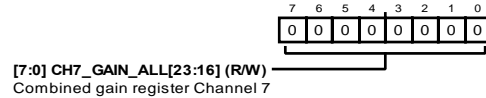

Table 116. Bit Descriptions for CH7_GAIN_UPPER_BYTE

| Bits | Bit Name | Settings | Description | Reset | Access |
|-------|---------------------|----------|----------------------------------|-------|--------|
| [7:0] | CH7_GAIN_ALL[23:16] | | Combined Gain Register Channel 7 | 0x0 | R/W |

CHANNEL 7 GAIN MIDDLE BYTE REGISTER

Address: 0x04A, Reset: 0x00, Name: CH7_GAIN_MID_BYTE

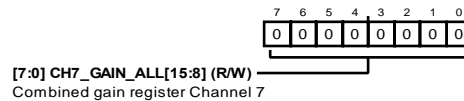

Table 117. Bit Descriptions for CH7_GAIN_MID_BYTE

| Bits | Bit Name | Settings | Description | Reset | Access |
|-------|--------------------|----------|----------------------------------|-------|--------|
| [7:0] | CH7_GAIN_ALL[15:8] | | Combined Gain Register Channel 7 | 0x0 | R/W |

CHANNEL 7 GAIN LOWER BYTE REGISTER

Address: 0x04B, Reset: 0x00, Name: CH7_GAIN_LOWER_BYTE

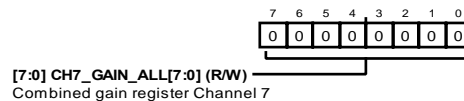

Table 118. Bit Descriptions for CH7_GAIN_LOWER_BYTE

| Bits | Bit Name | Settings | Description | Reset | Access |
|-------|-------------------|----------|----------------------------------|-------|--------|
| [7:0] | CH7_GAIN_ALL[7:0] | | Combined Gain Register Channel 7 | 0x0 | R/W |

CHANNEL 0 STATUS REGISTER

Address: 0x04C, Reset: 0x00, Name: CH0_ERR_REG

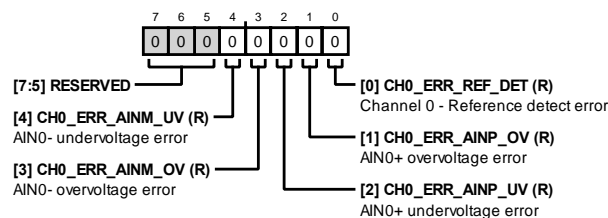

Table 119. Bit Descriptions for CH0_ERR_REG

| Bits | Bit Name | Settings | Description | Reset | Access |
|-------|-----------------|----------|------------------------------------|-------|--------|
| [7:5] | RESERVED | | Reserved | 0x0 | R/W |
| 4 | CH0_ERR_AINM_UV | | Channel 0—AIN0– Undervoltage Error | 0x0 | R |
| 3 | CH0_ERR_AINM_OV | | Channel 0—AIN0– Overvoltage Error | 0x0 | R |
| 2 | CH0_ERR_AINP_UV | | Channel 0—AIN0+ Undervoltage Error | 0x0 | R |
| 1 | CH0_ERR_AINP_OV | | Channel 0—AIN0+ Overvoltage Error | 0x0 | R |
| 0 | CH0_ERR_REF_DET | | Channel 0—Reference Detect Error | 0x0 | R |

CHANNEL 1 STATUS REGISTER

Address: 0x04D, Reset: 0x00, Name: CH1_ERR_REG

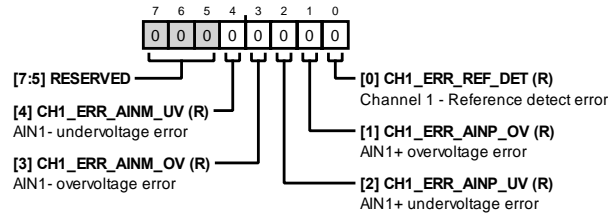

Table 120. Bit Descriptions for CH1_ERR_REG

| Bits | Bit Name | Settings | Description | Reset | Access |
|-------|-----------------|----------|------------------------------------|-------|--------|
| [7:5] | RESERVED | | Reserved | 0x0 | R/W |
| 4 | CH1_ERR_AINM_UV | | Channel 1—AIN1– Undervoltage Error | 0x0 | R |
| 3 | CH1_ERR_AINM_OV | | Channel 1—AIN1– Overvoltage Error | 0x0 | R |
| 2 | CH1_ERR_AINP_UV | | Channel 1—AIN1+ Undervoltage Error | 0x0 | R |
| 1 | CH1_ERR_AINP_OV | | Channel 1—AIN1+ Overvoltage Error | 0x0 | R |
| 0 | CH1_ERR_REF_DET | | Channel 1—Reference Detect Error | 0x0 | R |

CHANNEL 2 STATUS REGISTER

Address: 0x04E, Reset: 0x00, Name: CH2_ERR_REG

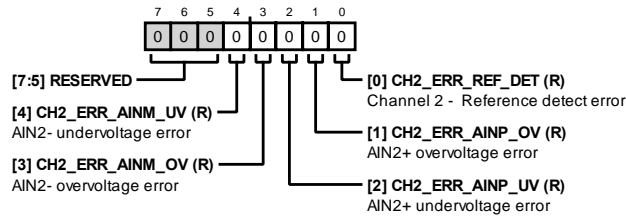

Table 121. Bit Descriptions for CH2_ERR_REG

| Bits | Bit Name | Settings | Description | Reset | Access |
|-------|-----------------|----------|------------------------------------|-------|--------|
| [7:5] | RESERVED | | Reserved | 0x0 | R/W |
| 4 | CH2_ERR_AINM_UV | | Channel 2—AIN2– Undervoltage Error | 0x0 | R |
| 3 | CH2_ERR_AINM_OV | | Channel 2—AIN2– Overvoltage Error | 0x0 | R |
| 2 | CH2_ERR_AINP_UV | | Channel 2—AIN2+ Undervoltage Error | 0x0 | R |
| 1 | CH2_ERR_AINP_OV | | Channel 2—AIN2+ Overvoltage Error | 0x0 | R |
| 0 | CH2_ERR_REF_DET | | Channel 2—Reference Detect Error | 0x0 | R |

CHANNEL 3 STATUS REGISTER

Address: 0x04F, Reset: 0x00, Name: CH3_ERR_REG

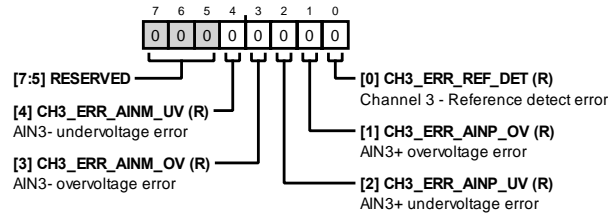

Table 122. Bit Descriptions for CH3_ERR_REG

| Bits | Bit Name | Settings | Description | Reset | Access |
|-------|-----------------|----------|------------------------------------|-------|--------|
| [7:5] | RESERVED | | Reserved | 0x0 | R/W |
| 4 | CH3_ERR_AINM_UV | | Channel 3—AIN3– Undervoltage Error | 0x0 | R |
| 3 | CH3_ERR_AINM_OV | | Channel 3—AIN3– Overvoltage Error | 0x0 | R |
| 2 | CH3_ERR_AINP_UV | | Channel 3—AIN3+ Undervoltage Error | 0x0 | R |
| 1 | CH3_ERR_AINP_OV | | Channel 3—AIN3+ Overvoltage Error | 0x0 | R |
| 0 | CH3_ERR_REF_DET | | Channel 3—Reference Detect Error | 0x0 | R |

CHANNEL 4 STATUS REGISTER

Address: 0x050, Reset: 0x00, Name: CH4_ERR_REG

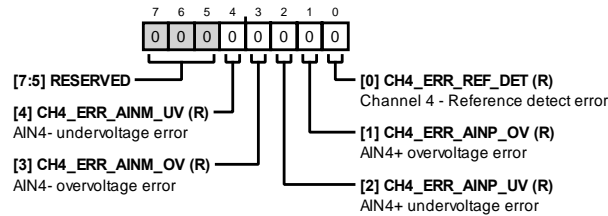

Table 123. Bit Descriptions for CH4_ERR_REG

| Bits | Bit Name | Settings | Description | Reset | Access |
|-------|-----------------|----------|------------------------------------|-------|--------|
| [7:5] | RESERVED | | Reserved | 0x0 | R/W |
| 4 | CH4_ERR_AINM_UV | | Channel 4—AIN4– Undervoltage Error | 0x0 | R |
| 3 | CH4_ERR_AINM_OV | | Channel 4—AIN4– Overvoltage Error | 0x0 | R |
| 2 | CH4_ERR_AINP_UV | | Channel 4—AIN4+ Undervoltage Error | 0x0 | R |
| 1 | CH4_ERR_AINP_OV | | Channel 4—AIN4+ Overvoltage Error | 0x0 | R |
| 0 | CH4_ERR_REF_DET | | Channel 4—Reference Detect Error | 0x0 | R |

CHANNEL 5 STATUS REGISTER

Address: 0x051, Reset: 0x00, Name: CH5_ERR_REG

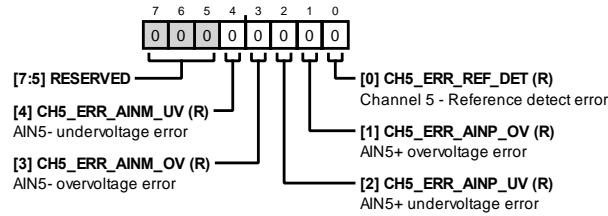

Table 124. Bit Descriptions for CH5_ERR_REG

| Bits | Bit Name | Settings | Description | Reset | Access |
|-------|-----------------|----------|------------------------------------|-------|--------|
| [7:5] | RESERVED | | Reserved | 0x0 | R/W |
| 4 | CH5_ERR_AINM_UV | | Channel 5—AIN5– Undervoltage Error | 0x0 | R |
| 3 | CH5_ERR_AINM_OV | | Channel 5—AIN5– Overvoltage Error | 0x0 | R |
| 2 | CH5_ERR_AINP_UV | | Channel 5—AIN5+ Undervoltage Error | 0x0 | R |
| 1 | CH5_ERR_AINP_OV | | Channel 5—AIN5+ Overvoltage Error | 0x0 | R |
| 0 | CH5_ERR_REF_DET | | Channel 5—Reference Detect Error | 0x0 | R |

CHANNEL 6 STATUS REGISTER

Address: 0x052, Reset: 0x00, Name: CH6_ERR_REG

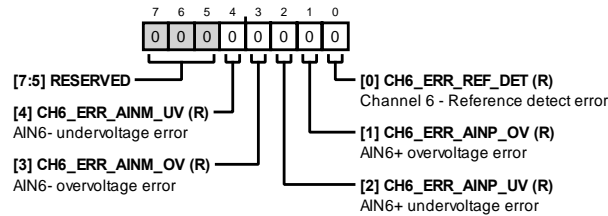

Table 125. Bit Descriptions for CH6_ERR_REG

| Bits | Bit Name | Settings | Description | Reset | Access |
|-------|-----------------|----------|------------------------------------|-------|--------|
| [7:5] | RESERVED | | Reserved | 0x0 | R/W |
| 4 | CH6_ERR_AINM_UV | | Channel 6—AIN6– Undervoltage Error | 0x0 | R |
| 3 | CH6_ERR_AINM_OV | | Channel 6—AIN6– Overvoltage Error | 0x0 | R |
| 2 | CH6_ERR_AINP_UV | | Channel 6—AIN6+ Undervoltage Error | 0x0 | R |
| 1 | CH6_ERR_AINP_OV | | Channel 6—AIN6+ Overvoltage Error | 0x0 | R |
| 0 | CH6_ERR_REF_DET | | Channel 6—Reference Detect Error | 0x0 | R |

CHANNEL 7 STATUS REGISTER

Address: 0x053, Reset: 0x00, Name: CH7_ERR_REG

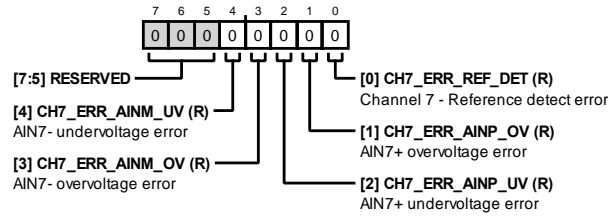

Table 126. Bit Descriptions for CH7_ERR_REG

| Bits | Bit Name | Settings | Description | Reset | Access |
|-------|-----------------|----------|------------------------------------|-------|--------|
| [7:5] | RESERVED | | Reserved | 0x0 | R |
| 4 | CH7_ERR_AINM_UV | | Channel 7—AIN7– Undervoltage Error | 0x0 | R |
| 3 | CH7_ERR_AINM_OV | | Channel 7—AIN7– Overvoltage Error | 0x0 | R |
| 2 | CH7_ERR_AINP_UV | | Channel 7—AIN7+ Undervoltage Error | 0x0 | R |
| 1 | CH7_ERR_AINP_OV | | Channel 7—AIN7+ Overvoltage Error | 0x0 | R |
| 0 | CH7_ERR_REF_DET | | Channel 7—Reference Detect Error | 0x0 | R |

CHANNEL 0/CHANNEL 1 DSP ERRORS REGISTER

Address: 0x054, Reset: 0x00, Name: CH0_1_SAT_ERR

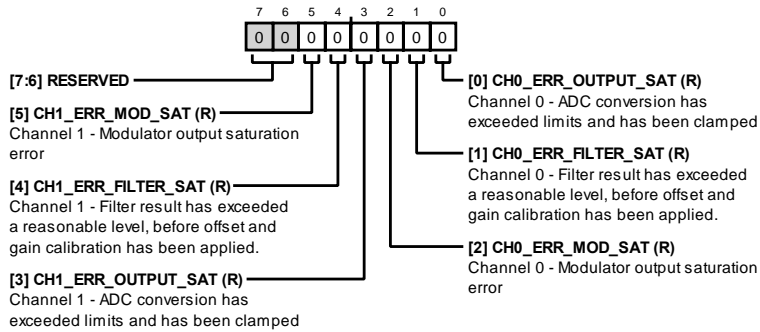

Table 127. Bit Descriptions for CH0_1_SAT_ERR

| Bits | Bit Name | Settings | Description | Reset | Access |
|-------|--------------------|----------|---|-------|--------|
| [7:6] | RESERVED | | Reserved | 0x0 | R |
| 5 | CH1_ERR_MOD_SAT | | Channel 1—Modulator output saturation error | 0x0 | R |
| 4 | CH1_ERR_FILTER_SAT | | Channel 1—Filter result has exceeded a reasonable level, before offset and gain calibration are applied | 0x0 | R |
| 3 | CH1_ERR_OUTPUT_SAT | | Channel 1—ADC conversion has exceeded limits and is clamped | 0x0 | R |
| 2 | CH0_ERR_MOD_SAT | | Channel 0—Modulator output saturation error | 0x0 | R |
| 1 | CH0_ERR_FILTER_SAT | | Channel 0—Filter result has exceeded a reasonable level, before offset and gain calibration are applied | 0x0 | R |
| 0 | CH0_ERR_OUTPUT_SAT | | Channel 0—ADC conversion has exceeded limits and is clamped | 0x0 | R |

CHANNEL 2/CHANNEL 3 DSP ERRORS REGISTER

Address: 0x055, Reset: 0x00, Name: CH2_3_SAT_ERR

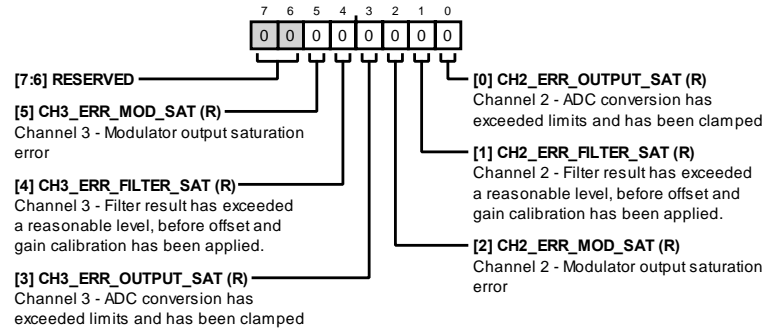

Table 128. Bit Descriptions for CH2_3_SAT_ERR

| Bits | Bit Name | Settings | Description | Reset | Access |
|-------|--------------------|----------|---|-------|--------|
| [7:6] | RESERVED | | Reserved | 0x0 | R |
| 5 | CH3_ERR_MOD_SAT | | Channel 3—Modulator output saturation error | 0x0 | R |
| 4 | CH3_ERR_FILTER_SAT | | Channel 3—Filter result has exceeded a reasonable level, before offset and gain calibration are applied | 0x0 | R |
| 3 | CH3_ERR_OUTPUT_SAT | | Channel 3—ADC conversion has exceeded limits and is clamped | 0x0 | R |
| 2 | CH2_ERR_MOD_SAT | | Channel 2—Modulator output saturation error | 0x0 | R |
| 1 | CH2_ERR_FILTER_SAT | | Channel 2—Filter result has exceeded a reasonable level, before offset and gain calibration are applied | 0x0 | R |
| 0 | CH2_ERR_OUTPUT_SAT | | Channel 2—ADC conversion has exceeded limits and has been clamped | 0x0 | R |

CHANNEL 4/CHANNEL 5 DSP ERRORS REGISTER

Address: 0x056, Reset: 0x00, Name: CH4_5_SAT_ERR

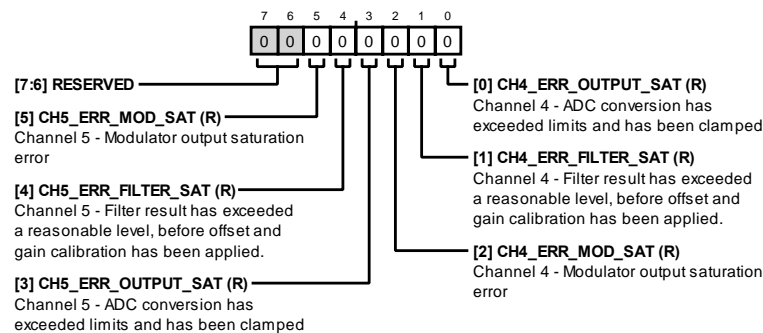

Table 129. Bit Descriptions for CH4_5_SAT_ERR

| Bits | Bit Name | Settings | Description | Reset | Access |
|-------|--------------------|----------|---|-------|--------|
| [7:6] | RESERVED | | Reserved | 0x0 | R |
| 5 | CH5_ERR_MOD_SAT | | Channel 5—Modulator output saturation error | 0x0 | R |
| 4 | CH5_ERR_FILTER_SAT | | Channel 5—Filter result has exceeded a reasonable level, before offset and gain calibration are applied | 0x0 | R |
| 3 | CH5_ERR_OUTPUT_SAT | | Channel 5—ADC conversion has exceeded limits and is clamped | 0x0 | R |
| 2 | CH4_ERR_MOD_SAT | | Channel 4—Modulator output saturation error | 0x0 | R |
| 1 | CH4_ERR_FILTER_SAT | | Channel 4—Filter result has exceeded a reasonable level, before offset and gain calibration are applied | 0x0 | R |
| 0 | CH4_ERR_OUTPUT_SAT | | Channel 4—ADC conversion has exceeded limits and is clamped | 0x0 | R |

CHANNEL 6/CHANNEL 7 DSP ERRORS REGISTER

Address: 0x057, Reset: 0x00, Name: CH6_7_SAT_ERR

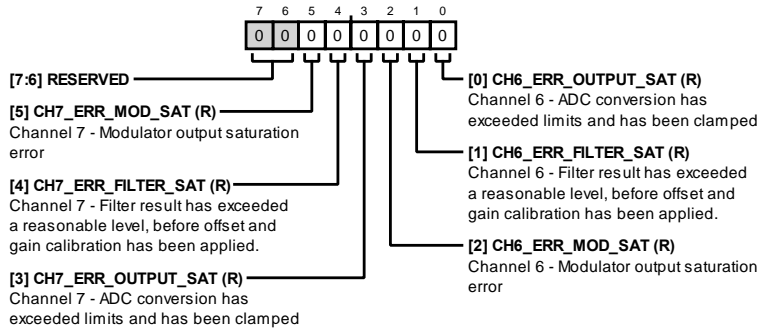

Table 130. Bit descriptions for CH6_7_SAT_ERR

| Bits | Bit Name | Settings | Description | Reset | Access |
|-------|--------------------|----------|---|-------|--------|
| [7:6] | RESERVED | | Reserved | 0x0 | R |
| 5 | CH7_ERR_MOD_SAT | | Channel 7—Modulator output saturation error | 0x0 | R |
| 4 | CH7_ERR_FILTER_SAT | | Channel 7—Filter result has exceeded a reasonable level, before offset and gain calibration are applied | 0x0 | R |
| 3 | CH7_ERR_OUTPUT_SAT | | Channel 7—ADC conversion has exceeded limits and is clamped | 0x0 | R |
| 2 | CH6_ERR_MOD_SAT | | Channel 6—Modulator output saturation error | 0x0 | R |
| 1 | CH6_ERR_FILTER_SAT | | Channel 6—Filter result has exceeded a reasonable level, before offset and gain calibration are applied | 0x0 | R |
| 0 | CH6_ERR_OUTPUT_SAT | | Channel 6—ADC conversion has exceeded limits and is clamped | 0x0 | R |

CHANNEL 0 TO CHANNEL 7 ERROR REGISTER ENABLE REGISTER

Address: 0x058, Reset: 0xFE, Name: CHX_ERR_REG_EN

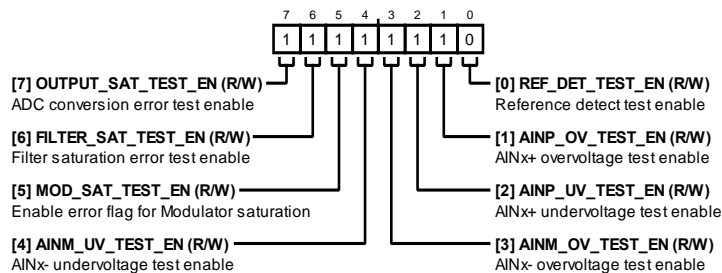

Table 131. Bit Descriptions for CHX_ERR_REG_EN

| Bits | Bit Name | Settings | Description | Reset | Access |
|------|--------------------|----------|--|-------|--------|
| 7 | OUTPUT_SAT_TEST_EN | | ADC Conversion Error Test Enable | 0x1 | R/W |
| 6 | FILTER_SAT_TEST_EN | | Filter Saturation Test Enable | 0x1 | R/W |
| 5 | MOD_SAT_TEST_EN | | Enable Error Flag for Modulator Saturation | 0x1 | R/W |
| 4 | AINM_UV_TEST_EN | | AINx- Undervoltage Test Enable | 0x1 | R/W |
| 3 | AINM_OV_TEST_EN | | AINx- Overvoltage Test Enable | 0x1 | R/W |
| 2 | AINP_UV_TEST_EN | | AINx+ Undervoltage Test Enable | 0x1 | R/W |
| 1 | AINP_OV_TEST_EN | | AINx+ Overvoltage Test Enable | 0x1 | R/W |
| 0 | REF_DET_TEST_EN | | Reference Detect Test Enable | 0x0 | R/W |

GENERAL ERRORS REGISTER 1

Address: 0x059, Reset: 0x00, Name: GEN_ERR_REG_1

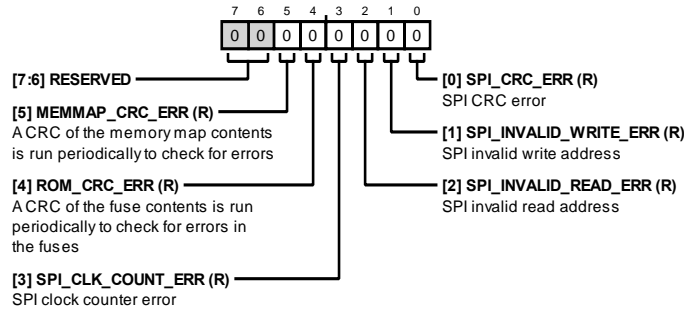

Table 132. Bit Descriptions for GEN_ERR_REG_1

| Bits | Bit Name | Settings | Description | Reset | Access |
|-------|-----------------------|----------|---|-------|--------|
| [7:6] | RESERVED | | Reserved | 0x0 | R |
| 5 | MEMMAP_CRC_ERR | | A CRC of the memory map contents is run periodically to check for errors | 0x0 | R |
| 4 | ROM_CRC_ERR | | A CRC of the fuse contents is run periodically to check for errors in the fuses | 0x0 | R |
| 3 | SPI_CLK_COUNT_ERR | | SPI clock counter error | 0x0 | R |
| 2 | SPI_INVALID_READ_ERR | | SPI invalid read address | 0x0 | R |
| 1 | SPI_INVALID_WRITE_ERR | | SPI invalid write address | 0x0 | R |
| 0 | SPI_CRC_ERR | | SPI CRC error | 0x0 | R |

GENERAL ERRORS REGISTER 1 ENABLE

Address: 0x05A, Reset: 0x3E, Name: GEN_ERR_REG_1_EN

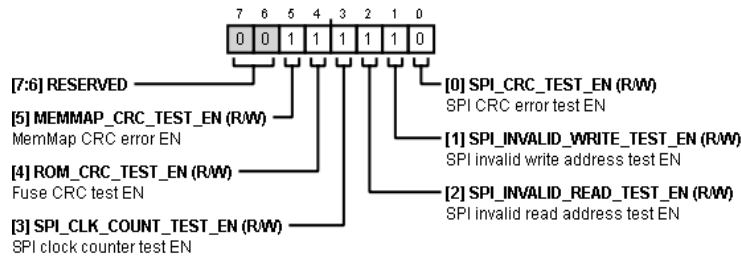

Table 133. Bit Descriptions for GEN_ERR_REG_1_EN

| Bits | Bit Name | Settings | Description | Reset | Access |
|-------|---------------------------|----------|---------------------------------------|-------|--------|
| [7:6] | RESERVED | | Reserved | 0x0 | R |
| 5 | MEMMAP_CRC_TEST_EN | | Memory Map CRC Test Error Enable | 0x1 | R/W |
| 4 | ROM_CRC_TEST_EN | | Fuse CRC Test Enable | 0x1 | R/W |
| 3 | SPI_CLK_COUNT_TEST_EN | | SPI Clock Counter Test Enable | 0x1 | R/W |
| 2 | SPI_INVALID_READ_TEST_EN | | SPI Invalid Read Address Test Enable | 0x1 | R/W |
| 1 | SPI_INVALID_WRITE_TEST_EN | | SPI Invalid Write Address Test Enable | 0x1 | R/W |
| 0 | SPI_CRC_TEST_EN | | SPI CRC Error Test Enable | 0x0 | R/W |

GENERAL ERRORS REGISTER 2

Address: 0x05B, Reset: 0x00, Name: GEN_ERR_REG_2

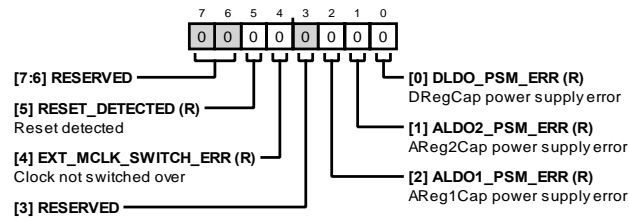

Table 134. Bit Descriptions for GEN_ERR_REG_2

| Bits | Bit Name | Settings | Description | Reset | Access |
|-------|---------------------|----------|-----------------------------|-------|--------|
| [7:6] | RESERVED | | Reserved | 0x0 | R |
| 5 | RESET_DETECTED | | Reset Detected | 0x0 | R |
| 4 | EXT_MCLK_SWITCH_ERR | | Clock Not Switched Over | 0x0 | R |
| 3 | RESERVED | | Reserved | 0x0 | R |
| 2 | ALDO1_PSM_ERR | | AREG1CAP Power Supply Error | 0x0 | R |
| 1 | ALDO2_PSM_ERR | | AREG2CAP Power Supply Error | 0x0 | R |
| 0 | DLDO_PSM_ERR | | DREGCAP Power Supply Error | 0x0 | R |

GENERAL ERRORS REGISTER 2 ENABLE

Address: 0x05C, Reset: 0x3C, Name: GEN_ERR_REG_2_EN

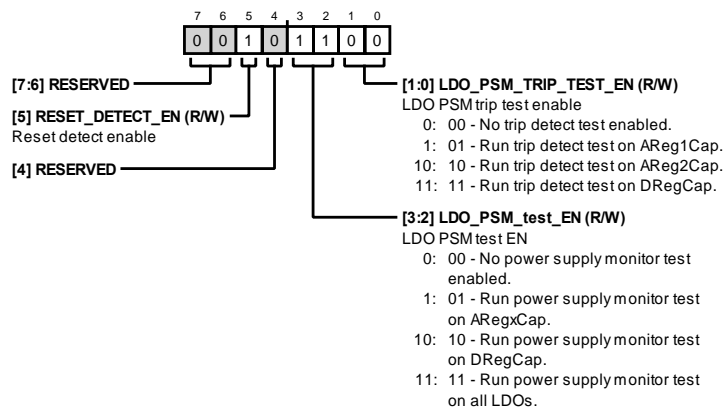

Table 135. Bit Descriptions for GEN_ERR_REG_2_EN

| Bits | Bit Name | Settings | Description | Reset | Access |
|-------|----------------------|----------|--|-------|--------|
| [7:6] | RESERVED | | Reserved | 0x0 | R |
| 5 | RESET_DETECT_EN | | Reset Detect Enable | 0x1 | R/W |
| 4 | RESERVED | | Reserved | 0x1 | R/W |
| [3:2] | LDO_PSM_TEST_EN | | LDO PSM Test Enable | 0x3 | R/W |
| | | 0 | 00—No power supply monitor test enabled | | |
| | | 1 | 01—Run power supply monitor test on AREGxCAP | | |
| | | 10 | 10—Run power supply monitor test on DREGCAP | | |
| | | 11 | 11—Run power supply monitor test on all LDOs | | |
| [1:0] | LDO_PSM_TRIP_TEST_EN | | LDO PSM Trip Test Enable | 0x0 | R/W |
| | | 0 | 00—No trip detect test enabled | | |
| | | 1 | 01—Run trip detect test on AREG1CAP | | |
| | | 10 | 10—Run trip detect test on AREG2CAP | | |
| | | 11 | 11—Run trip detect test on DREGCAP | | |

ERROR STATUS REGISTER 1

Address: 0x05D, Reset: 0x00, Name: STATUS_REG_1

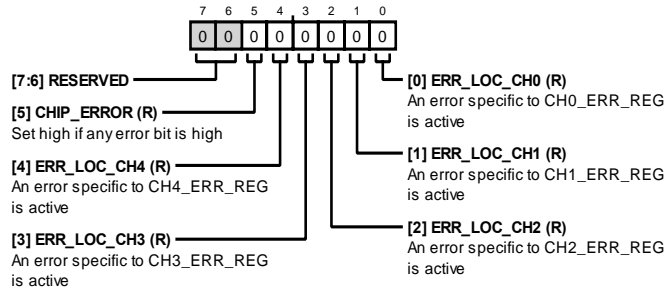

Table 136. Bit Descriptions for STATUS_REG_1

| Bits | Bit Name | Settings | Description | Reset | Access |
|-------|-------------|----------|--|-------|--------|
| [7:6] | RESERVED | | Reserved | 0x0 | R |
| 5 | CHIP_ERROR | | Set this bit high if any error bit is high | 0x0 | R |
| 4 | ERR_LOC_CH4 | | An error specific to CH4_ERR_REG is active | 0x0 | R |
| 3 | ERR_LOC_CH3 | | An error specific to CH3_ERR_REG is active | 0x0 | R |
| 2 | ERR_LOC_CH2 | | An error specific to CH2_ERR_REG is active | 0x0 | R |
| 1 | ERR_LOC_CH1 | | An error specific to CH1_ERR_REG is active | 0x0 | R |
| 0 | ERR_LOC_CH0 | | An error specific to CH0_ERR_REG is active | 0x0 | R |

ERROR STATUS REGISTER 2

Address: 0x05E, Reset: 0x00, Name: STATUS_REG_2

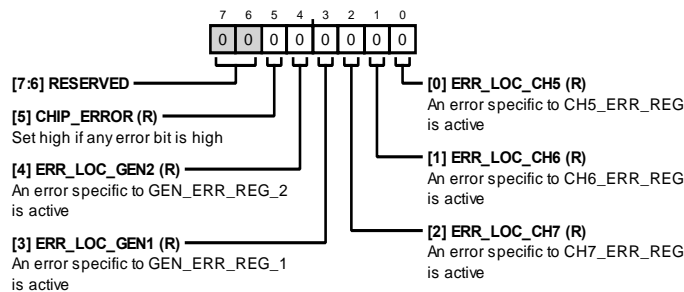

Table 137. Bit Descriptions for STATUS_REG_2

| Bits | Bit Name | Settings | Description | Reset | Access |
|-------|--------------|----------|--|-------|--------|
| [7:6] | RESERVED | | Reserved | 0x0 | R |
| 5 | CHIP_ERROR | | Set high if any error bit is high | 0x0 | R |
| 4 | ERR_LOC_GEN2 | | An error specific to GEN_ERR_REG_2 is active | 0x0 | R |
| 3 | ERR_LOC_GEN1 | | An error specific to GEN_ERR_REG_1 is active | 0x0 | R |
| 2 | ERR_LOC_CH7 | | An error specific to CH7_ERR_REG is active | 0x0 | R |
| 1 | ERR_LOC_CH6 | | An error specific to CH6_ERR_REG is active | 0x0 | R |
| 0 | ERR_LOC_CH5 | | An error specific to CH5_ERR_REG is active | 0x0 | R |

ERROR STATUS REGISTER 3

Address: 0x05F, Reset: 0x00, Name: STATUS_REG_3

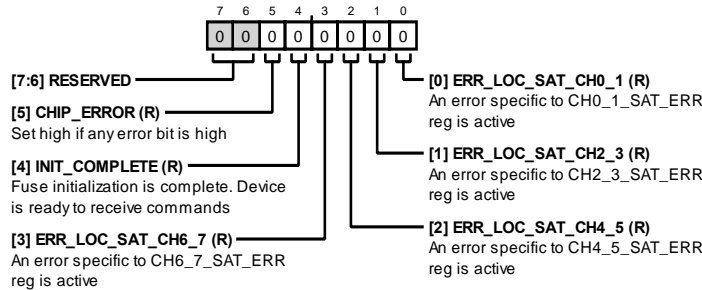

Table 138. Bit Descriptions for STATUS_REG_3

| Bits | Bit Name | Settings | Description | Reset | Access |
|-------|-------------------|----------|---|-------|--------|
| [7:6] | RESERVED | | Reserved | 0x0 | R |
| 5 | CHIP_ERROR | | Set high if any error bit is high. | 0x0 | R |
| 4 | INIT_COMPLETE | | Fuse initialization is complete. Device is ready to receive commands. | 0x0 | R |
| 3 | ERR_LOC_SAT_CH6_7 | | An error specific to CH6_7_SAT_ERR register is active. | 0x0 | R |
| 2 | ERR_LOC_SAT_CH4_5 | | An error specific to CH4_5_SAT_ERR register is active. | 0x0 | R |
| 1 | ERR_LOC_SAT_CH2_3 | | An error specific to CH2_3_SAT_ERR register is active. | 0x0 | R |
| 0 | ERR_LOC_SAT_CH0_1 | | An error specific to CH0_1_SAT_ERR register is active. | 0x0 | R |

DECIMATION RATE (N) MSB REGISTER

Address: 0x060, Reset: 0x00, Name: SRC_N_MSB

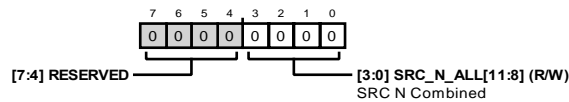

Table 139. Bit Descriptions for SRC_N_MSB

| Bits | Bit Name | Settings | Description | Reset | Access |
|-------|-----------------|----------|----------------|-------|--------|
| [7:4] | RESERVED | | Reserved | 0x0 | R |
| [3:0] | SRC_N_ALL[11:8] | | SRC N Combined | 0x0 | R/W |

DECIMATION RATE (N) LSB REGISTER

Address: 0x061, Reset: 0x80, Name: SRC_N_LSB

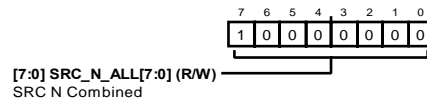

Table 140. Bit Descriptions for SRC_N_LSB

| Bits | Bit Name | Settings | Description | Reset | Access |
|-------|----------------|----------|----------------|-------|--------|
| [7:0] | SRC_N_ALL[7:0] | | SRC N Combined | 0x0 | R/W |

DECIMATION RATE (IF) MSB REGISTER

Address: 0x062, Reset: 0x00, Name: SRC_IF_MSB

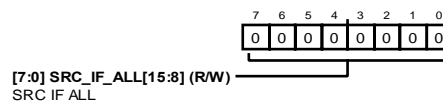

Table 141. Bit Descriptions for SRC_IF_MSB

| Bits | Bit Name | Settings | Description | Reset | Access |
|-------|------------------|----------|-------------|-------|--------|
| [7:0] | SRC_IF_ALL[15:8] | | SRC IF All | 0x0 | R/W |

DECIMATION RATE (IF) LSB REGISTER

Address: 0x063, Reset: 0x00, Name: SRC_IF_LSB

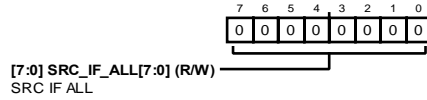

Table 142. Bit Descriptions for SRC_IF_LSB

| Bits | Bit Name | Settings | Description | Reset | Access |
|-------|-----------------|----------|-------------|-------|--------|
| [7:0] | SRC_IF_ALL[7:0] | | SRC IF All | 0x0 | R/W |

SRC LOAD SOURCE AND LOAD UPDATE REGISTER

Address: 0x064, Reset: 0x00, Name: SRC_UPDATE

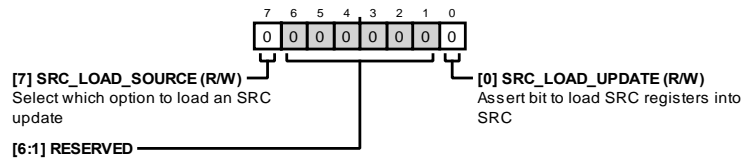
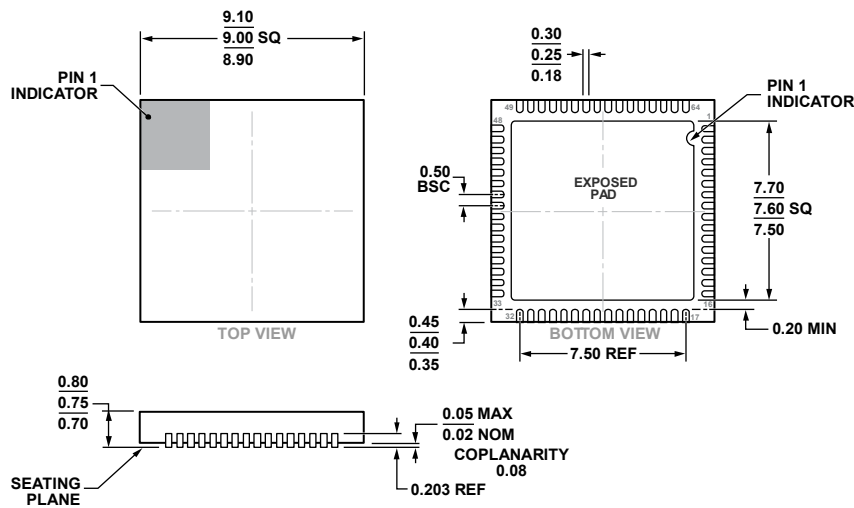

Table 143. Bit Descriptions for SRC_UPDATE

| Bits | Bit Name | Settings | Description | Reset | Access |
|-------|-----------------|----------|--|-------|--------|
| 7 | SRC_LOAD_SOURCE | | Selects which option to load an SRC update | 0x0 | R/W |
| [6:1] | RESERVED | | Reserved | 0x0 | R |
| 0 | SRC_LOAD_UPDATE | | Asserts bit to load SRC registers into SRC | 0x0 | R/W |

OUTLINE DIMENSIONS



COMPLIANT TO JEDEC STANDARDS MO-220-WMMD

Figure 139. 64-Lead Lead Frame Chip Scale Package [LFCSP]
 9 mm × 9 mm Body and 0.75 mm Package Height
 (CP-64-15)

Dimensions shown in millimeters

ORDERING GUIDE

| Model ¹ | Temperature Range | Package Description | Package Option |
|--------------------|-------------------|---|----------------|
| AD7771BCPZ | -40°C to +125°C | 64-Lead Lead Frame Chip Scale Package [LFCSP] | CP-64-15 |
| AD7771BCPZ-RL | -40°C to +125°C | 64-Lead Lead Frame Chip Scale Package [LFCSP] | CP-64-15 |
| EVAL-AD7771FMCZ | | Evaluation Board | |

¹ Z = RoHS Compliant Part.