

Automotive-grade 390 V internally clamped IGBT E_{SCIS} 180 mJ

Datasheet - production data

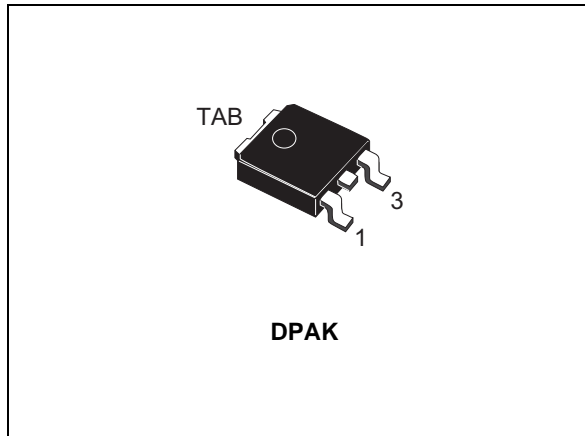
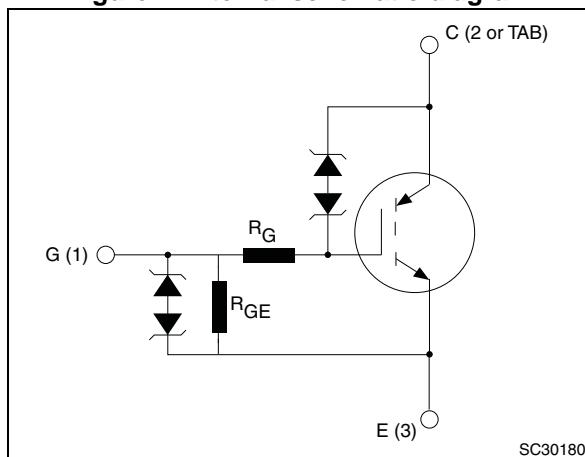

Figure 1. Internal schematic diagram



Features



- AEC-Q101 qualified
- 180 mJ of avalanche energy @ $T_C = 150\text{ }^\circ\text{C}$, $L = 3\text{ mH}$
- ESD gate-emitter protection
- Gate-collector high voltage clamping
- Logic level gate drive
- Low saturation voltage
- High pulsed current capability
- Gate and gate-emitter resistor

Applications

- Pencil coil electronic ignition driver

Description

This application-specific IGBT utilizes the most advanced PowerMESH™ technology. The built-in Zener diodes between gate-collector and gate-emitter provide overvoltage protection capabilities. The device also exhibits low on-state voltage drop and low threshold drive for use in automotive ignition systems.

Table 1. Device summary

Order code	Marking	Packages	Packing
STGD19N40LZ	GD19N40LZ	DPAK	Tape and reel

Contents

- 1 Electrical ratings 3**
- 2 Electrical characteristics 4**
 - 2.1 Electrical characteristics (curves) 6
- 3 Test circuits 9**
- 4 Package information 10**
 - 4.1 DPAK (TO-252) type A2 package information11
 - 4.2 Packing information 14
- 5 Revision history 16**



1 Electrical ratings

Table 2. Absolute maximum ratings

Symbol	Parameter	Value	Unit
V_{CES}	Collector-emitter voltage ($V_{GE} = 0$)	$V_{CES(\text{clamped})}$	V
V_{ECS}	Emitter collector voltage ($V_{GE} = 0$)	20	V
$I_C^{(1)}$	Collector current (continuous) at $T_C = 100\text{ °C}$	25	A
$I_{CP}^{(2)}$	Pulsed collector current	40	A
V_{GE}	Gate-emitter voltage	$V_{GE(\text{clamped})}$	V
P_{TOT}	Total dissipation at $T_C = 25\text{ °C}$	125	W
$E_{SCIS}^{(3)}$	Single pulse energy $T_C = 25\text{ °C}$, $L = 3\text{ mH}$, $V_{CC} = 50\text{ V}$	300	mJ
	Single pulse energy $T_C = 150\text{ °C}$, $L = 3\text{ mH}$, $V_{CC} = 50\text{ V}$	180	mJ
I_{SCIS}	Avalanche current $T_C = 25\text{ °C}$, $L = 3\text{ mH}$, $V_{CC} = 50\text{ V}$	13.1	A
	Avalanche current $T_C = 150\text{ °C}$, $L = 3\text{ mH}$, $V_{CC} = 50\text{ V}$	10.2	A
ESD	Human body model, $R = 1.5\text{ k}\Omega$, $C = 100\text{ pF}$	8	kV
	Machine model, $R = 0$, $C = 100\text{ pF}$	800	V
	Charged device model	2	kV
T_{STG}	Storage temperature	- 55 to 175	°C
T_J	Operating junction temperature		

1. Calculated according to the iterative formula

$$I_C(T_C) = \frac{T_{j(\text{max})} - T_C}{R_{thj-c} \times V_{CE(\text{sat})(\text{max})}(T_{j(\text{max})}, I_C(T_C))}$$

2. Pulse width limited by max. junction temperature allowed

3. For E_{SCIS} test circuit refer to [Figure 16](#). (Inductive load switching), with A and B not connected.

Table 3. Thermal data

Symbol	Parameter	Value	Unit
$R_{thj-case}$	Thermal resistance junction-case	1.2	°C/W
$R_{thj-amb}$	Thermal resistance junction-ambient device in free air	100	°C/W

2 Electrical characteristics

$T_J = 25\text{ °C}$ unless otherwise specified.

Table 4. Static electrical characteristics

Symbol	Parameter	Test conditions	Min.	Typ.	Max.	Unit
$V_{CES(\text{clamped})}$	Collector emitter clamped voltage ($V_{GE} = 0$)	$I_C = 2\text{ mA}$		390		V
		$I_C = 2\text{ mA}, T_J = -40\text{ °C to }175\text{ °C}$	365		425	V
$V_{(BR)ECS}$	Emitter collector break-down voltage ($V_{GE} = 0$)	$I_C = 75\text{ mA}$		28		V
		$I_C = 75\text{ mA}, T_J = -40\text{ °C to }175\text{ °C}$	20			V
$V_{GE(\text{clamped})}$	Gate emitter clamped voltage	$I_G = \pm 2\text{ mA}$ $T_J = -40\text{ °C to }175\text{ °C}$	12		16	V
I_{CES}	Collector cut-off current ($V_{GE} = 0$)	$V_{CE} = 15\text{ V}, T_J = 175\text{ °C}$			20	μA
		$V_{CE} = 200\text{ V}, T_J = 175\text{ °C}$			100	μA
I_{GES}	Gate-emitter leakage current ($V_{CE} = 0$)	$V_{GE} = \pm 10\text{ V}$		625		μA
		$V_{GE} = \pm 10\text{ V}, T_J = -40\text{ °C to }175\text{ °C}$	450		830	μA
R_{GE}	Gate emitter resistance	$0 < V_{GE} < V_{GE}(\text{clamped})$	12	16	22	$\text{k}\Omega$
R_G	Gate resistance			1.6		$\text{k}\Omega$
$V_{GE(\text{th})}$	Gate threshold voltage	$V_{GE} = V_{CE}, I_C = 1\text{ mA}, T_J = -40\text{ °C}$	1.75	2.3	2.9	V
		$V_{GE} = V_{CE}, I_C = 1\text{ mA}$	1.55	2.0	2.6	V
		$V_{GE} = V_{CE}, I_C = 1\text{ mA}, T_J = 175\text{ °C}$	1.05	1.4	2.0	V
$V_{CE(\text{sat})}$	Collector emitter saturation voltage	$V_{GE} = 4.5\text{ V}, I_C = 10\text{ A}$		1.5		V
		$V_{GE} = 4.5\text{ V}, I_C = 10\text{ A}, T_J = -40\text{ °C to }175\text{ °C}$			1.85	V
		$V_{GE} = 3.8\text{ V}, I_C = 6\text{ A}$		1.35		V
		$V_{GE} = 3.8\text{ V}, I_C = 6\text{ A}, T_J = -40\text{ °C to }175\text{ °C}$			1.65	V

Table 5. Dynamic electrical characteristics

Symbol	Parameter	Test conditions	Min.	Typ.	Max.	Unit
C_{ies}	Input capacitance	$V_{CE} = 25\text{ V}$, $f = 1\text{ MHz}$, $V_{GE} = 0$	-	730	-	pF
C_{oes}	Output capacitance		-	85	-	pF
C_{res}	Reverse transfer capacitance		-	4	-	pF
Q_g	Gate charge	$V_{CE} = 280\text{ V}$, $I_C = 10\text{ A}$, $V_{GE} = 5\text{ V}$	-	17	-	nC

Table 6. Switching on/off

Symbol	Parameter	Test conditions	Min.	Typ.	Max.	Unit
$t_{d(on)}$ t_r	Resistive load	$V_{CC} = 14\text{ V}$, $R_L = 1\ \Omega$, $V_{GE} = 5\text{ V}$ $R_G = 1\text{ k}\Omega$	-	0.65	-	μs
	Turn-on delay time					
$t_{d(on)}$ t_r	Resistive load	$V_{CC} = 14\text{ V}$, $R_L = 1\ \Omega$, $V_{GE} = 5\text{ V}$, $R_G = 1\text{ k}\Omega$, $T_J = 150\text{ }^\circ\text{C}$	-	0.65	-	μs
	Turn-on delay time					
$t_{d(off)}$ t_f dv/dt	Inductive load	$V_{CC} = 300\text{ V}$, $L = 1\text{ mH}$ $I_C = 10\text{ A}$, $V_{GE} = 5\text{ V}$, $R_G = 1\text{ k}\Omega$	-	13.5	-	μs
	Turn-off delay time					
	Fall time					
$t_{d(off)}$ t_f dv/dt	Inductive load	$V_{CC} = 300\text{ V}$, $L = 1\text{ mH}$ $I_C = 10\text{ A}$, $V_{GE} = 5\text{ V}$, $R_G = 1\text{ k}\Omega$, $T_J = 150\text{ }^\circ\text{C}$	-	14.2	-	μs
	Turn-off delay time					
	Fall time					
	Turn-off voltage slope			8		μs
	Turn-off voltage slope			97		V/ μs

2.1 Electrical characteristics (curves)

Figure 2. Collector-emitter on voltage vs. temperature ($I_C = 6\text{ A}$)

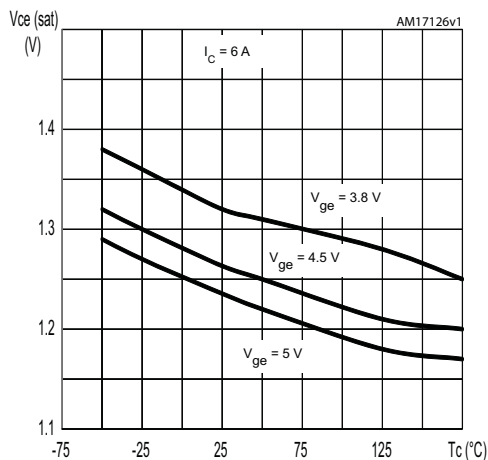

Figure 3. Collector-emitter on voltage vs. temperature ($I_C = 10\text{ A}$)

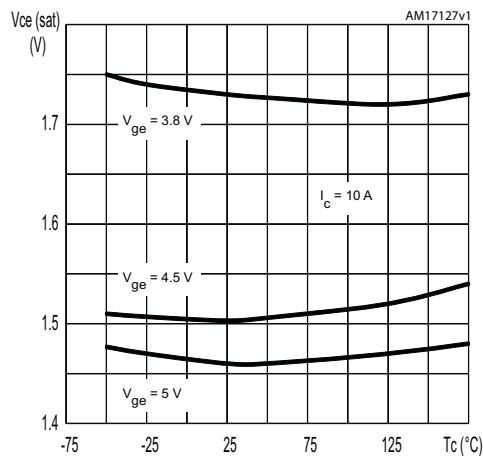

Figure 4. Collector-emitter on voltage vs. temperature ($V_{GE} = 4.5\text{ V}$)

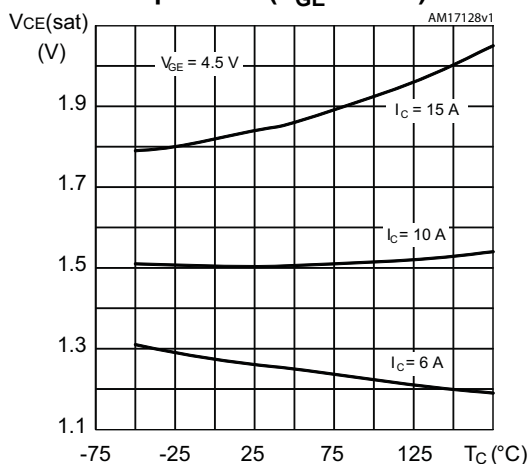

Figure 5. Self clamped inductive switch

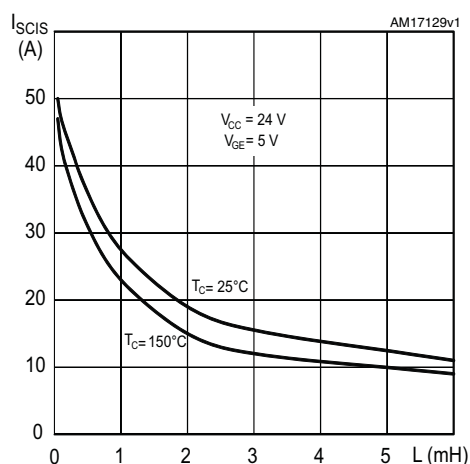

Figure 6. Output characteristics ($T_J = 25\text{ }^{\circ}\text{C}$)

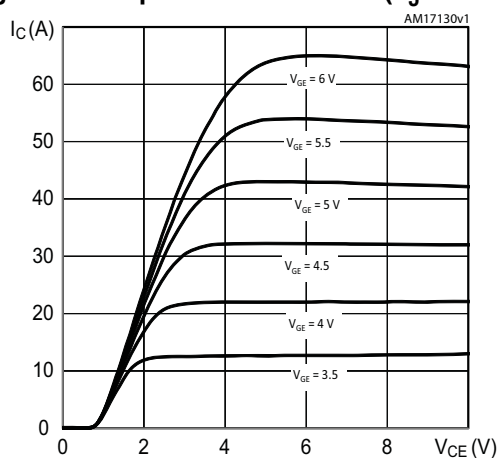

Figure 7. Output characteristics ($T_J = -175\text{ }^{\circ}\text{C}$)

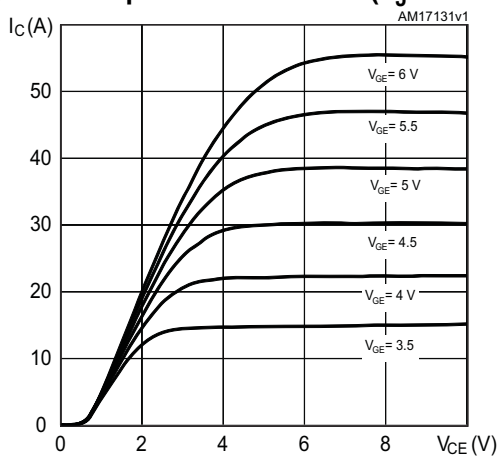

Figure 8. Output characteristics ($T_J = -40\text{ }^\circ\text{C}$)

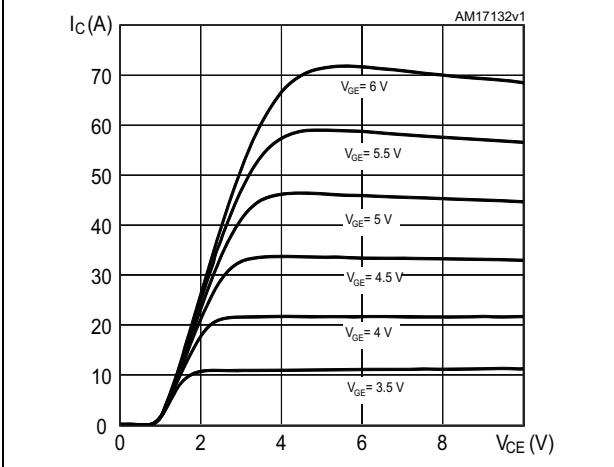

Figure 9. Transfer characteristics

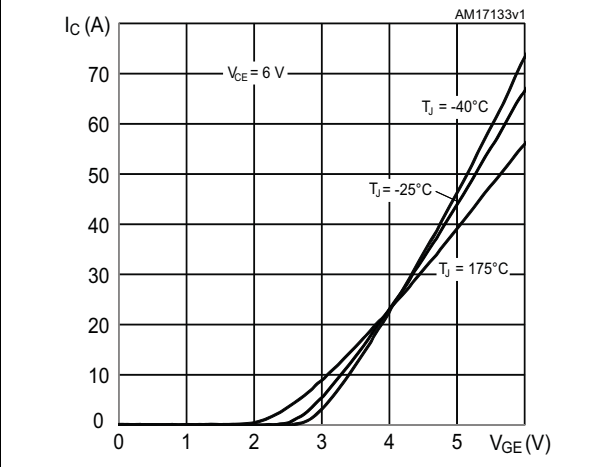

Figure 10. Collector cut-off current vs. temperature

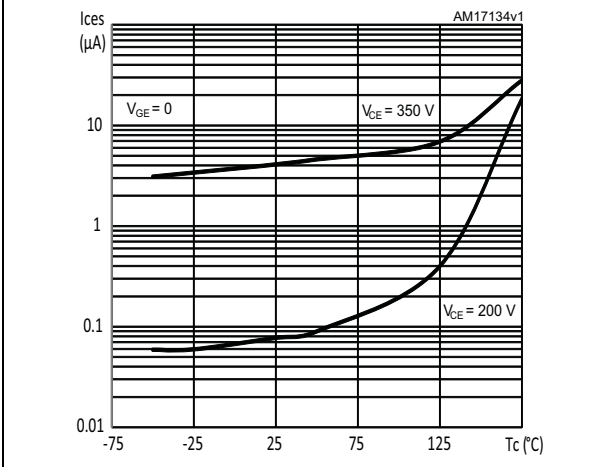

Figure 11. Normalized collector emitter voltage vs. temperature ($I_C = 2\text{ mA}$)

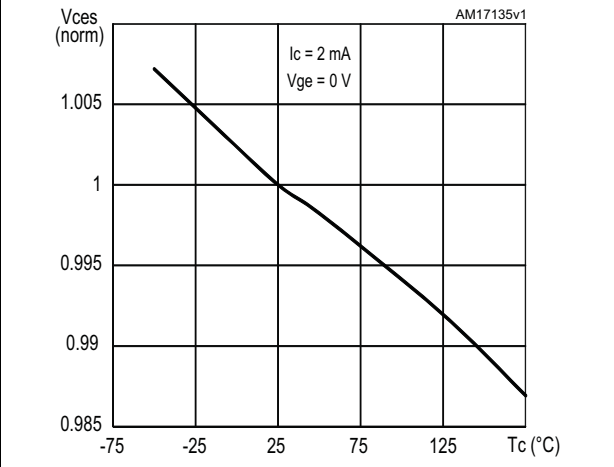

Figure 12. Normalized gate threshold voltage vs. temperature

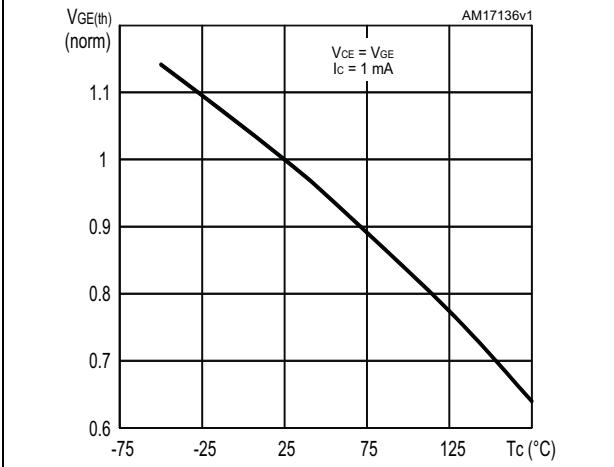
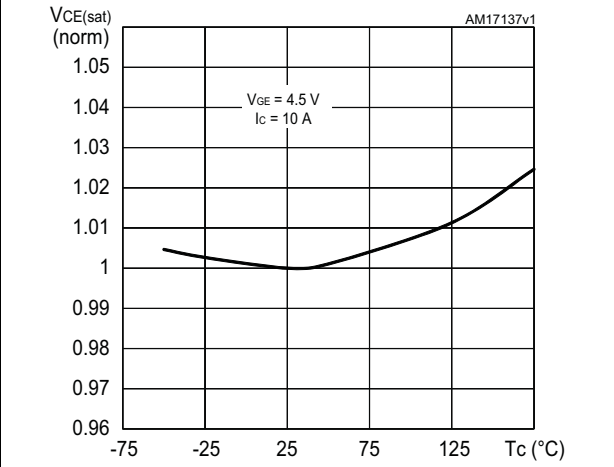
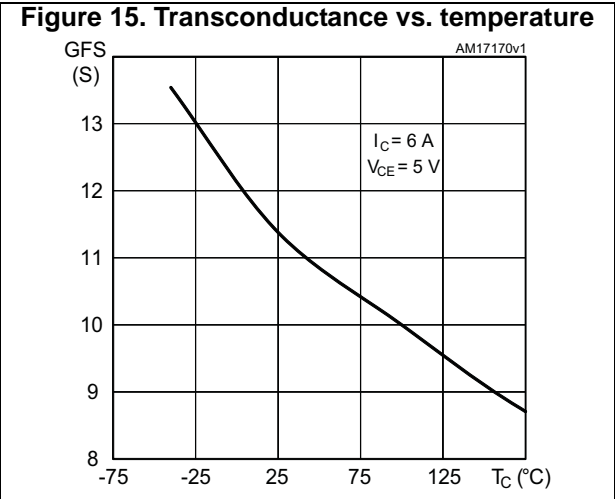
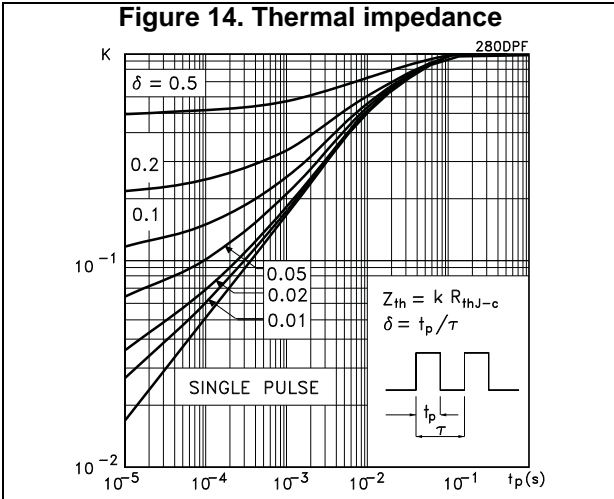

Figure 13. Normalized collector emitter on voltage vs. temperature ($I_C = 10\text{ A}$)





4 Package information

In order to meet environmental requirements, ST offers these devices in different grades of ECOPACK[®] packages, depending on their level of environmental compliance. ECOPACK[®] specifications, grade definitions and product status are available at: www.st.com. ECOPACK[®] is an ST trademark.

4.1 DPAK (TO-252) type A2 package information

Figure 20. DPAK (TO-252) type A2 package outline

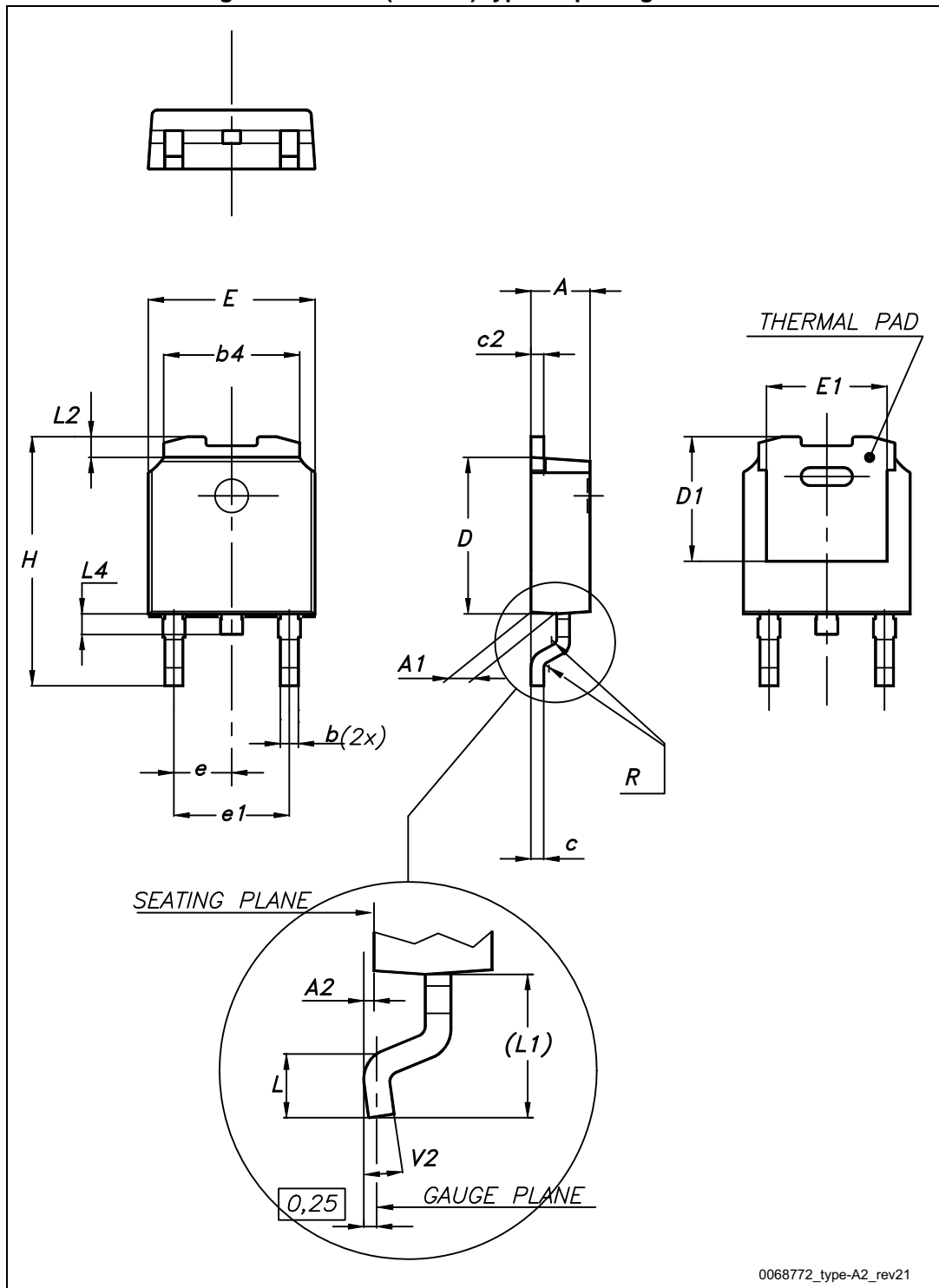
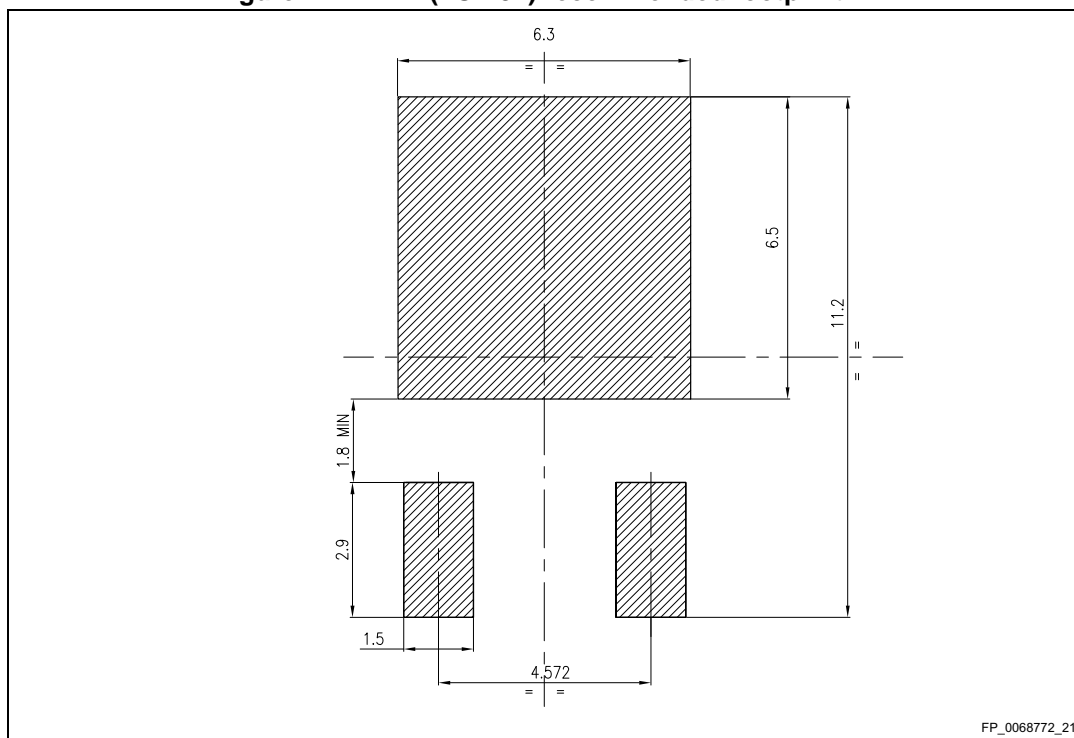

Table 7. DPAK (TO-252) type A2 mechanical data

Dim.	mm		
	Min.	Typ.	Max.
A	2.20		2.40
A1	0.90		1.10
A2	0.03		0.23
b	0.64		0.90
b4	5.20		5.40
c	0.45		0.60
c2	0.48		0.60
D	6.00		6.20
D1	4.95	5.10	5.25
E	6.40		6.60
E1	5.10	5.20	5.30
e	2.16	2.28	2.40
e1	4.40		4.60
H	9.35		10.10
L	1.00		1.50
L1	2.60	2.80	3.00
L2	0.65	0.80	0.95
L4	0.60		1.00
R		0.20	
V2	0°		8°

Figure 21. DPAK (TO-252) recommended footprint (a)



a. All dimensions are in millimeters

4.2 Packing information

Figure 22. Tape outline for DPAK (TO-252)

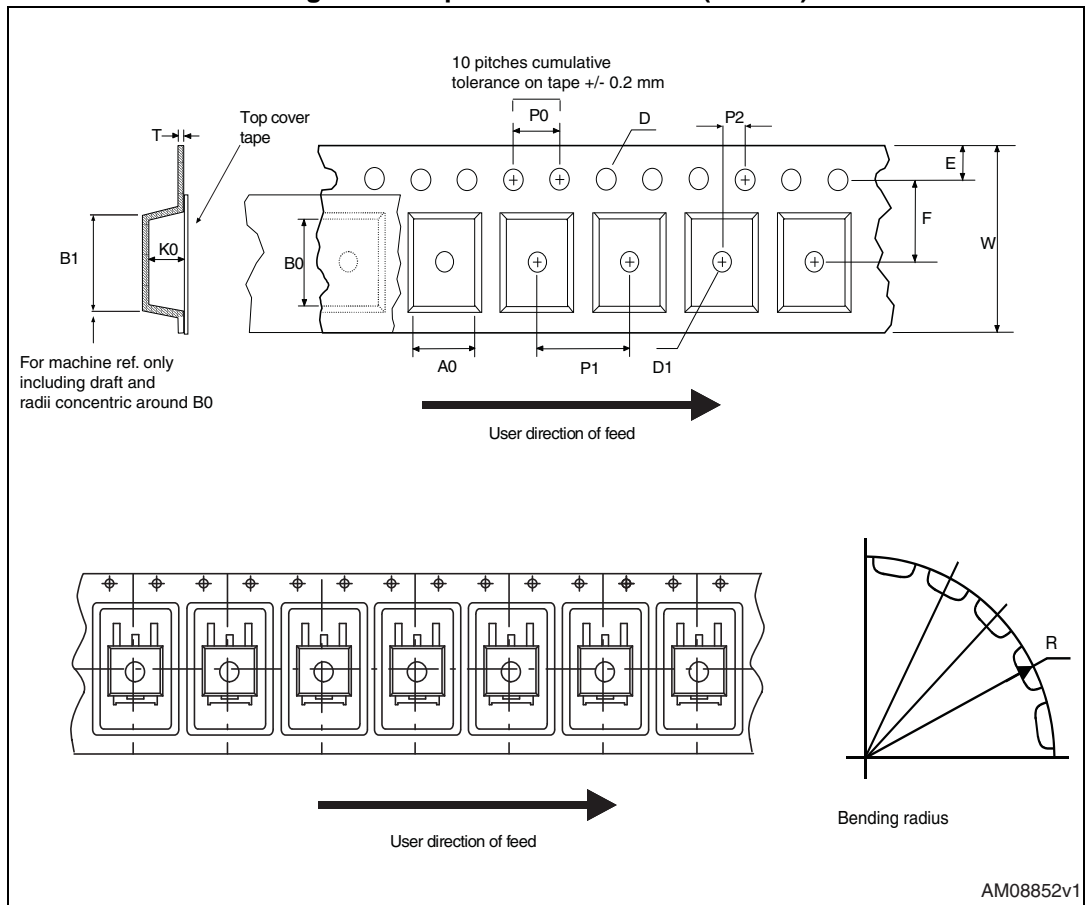

AM08852v1

Figure 23. Reel outline for DPAK (TO-252)

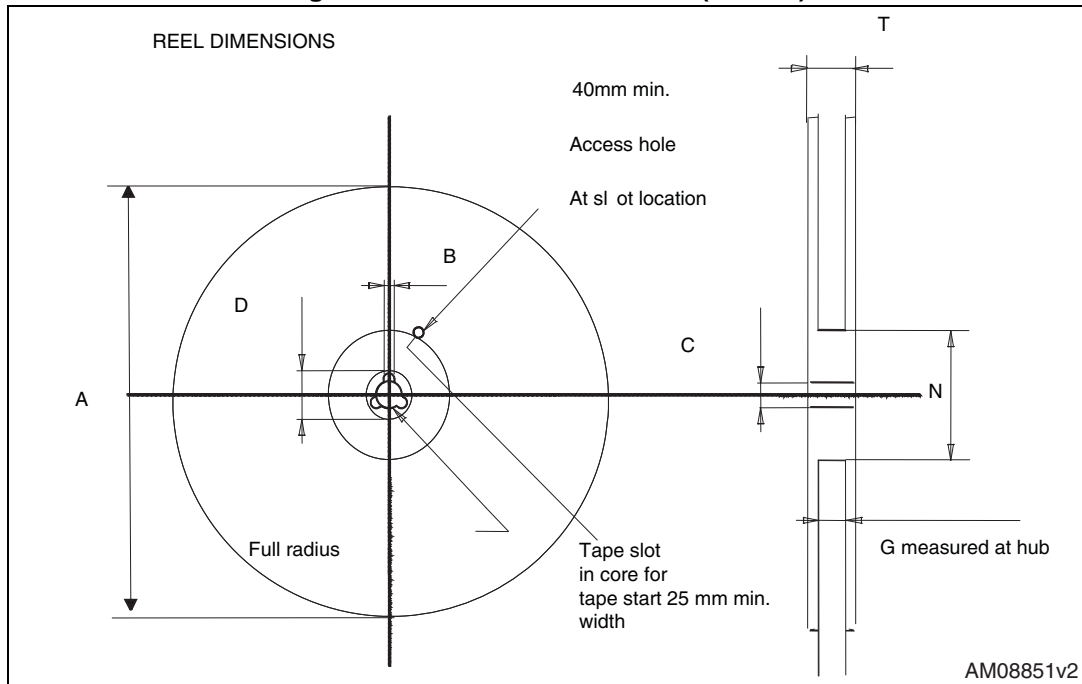

Table 8. DPAK (TO-252) tape and reel mechanical data

Tape			Reel		
Dim.	mm		Dim.	mm	
	Min.	Max.		Min.	Max.
A0	6.8	7	A		330
B0	10.4	10.6	B	1.5	
B1		12.1	C	12.8	13.2
D	1.5	1.6	D	20.2	
D1	1.5		G	16.4	18.4
E	1.65	1.85	N	50	
F	7.4	7.6	T		22.4
K0	2.55	2.75			
P0	3.9	4.1		Base qty.	2500
P1	7.9	8.1		Bulk qty.	2500
P2	1.9	2.1			
R	40				
T	0.25	0.35			
W	15.7	16.3			

5 Revision history

Table 9. Document revision history

Date	Revision	Changes
22-Apr-2013	1	Initial release.
20-May-2013	2	Added <i>Figure 15</i> .
17-Apr-2014	3	Modified title and features Modified $V_{CES(\text{clamped})}$, $V_{(BR)ECS}$ and I_{GES} test conditions Modified <i>Figure 5</i> and <i>9</i> Updated <i>Section 4: Package information</i> Minor text changes
04-Jun-2014	4	Updated features in cover page.
30-Jul-2015	5	Text and formatting changes throughout document. Updated <i>Section 4: Package information</i>
05-Oct-2016	6	Updated <i>Figure 9: Transfer characteristics</i> . Minor text changes.

IMPORTANT NOTICE – PLEASE READ CAREFULLY

STMicroelectronics NV and its subsidiaries ("ST") reserve the right to make changes, corrections, enhancements, modifications, and improvements to ST products and/or to this document at any time without notice. Purchasers should obtain the latest relevant information on ST products before placing orders. ST products are sold pursuant to ST's terms and conditions of sale in place at the time of order acknowledgement.

Purchasers are solely responsible for the choice, selection, and use of ST products and ST assumes no liability for application assistance or the design of Purchasers' products.

No license, express or implied, to any intellectual property right is granted by ST herein.

Resale of ST products with provisions different from the information set forth herein shall void any warranty granted by ST for such product.

ST and the ST logo are trademarks of ST. All other product or service names are the property of their respective owners.

Information in this document supersedes and replaces information previously supplied in any prior versions of this document.

© 2016 STMicroelectronics – All rights reserved

