



US8A THRU US8M

SURFACE MOUNT ULTRA FAST RECTIFIER

Reverse Voltage - 50 to 1000 Volts Forward Current - 8.0 Amperes

DO-214AB/SMC

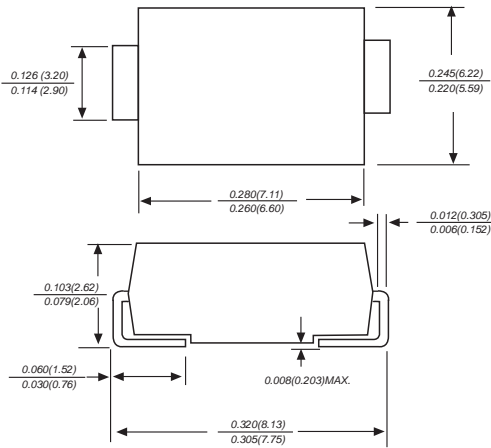

FEATURES

- ◆ The plastic package carries Underwriters Laboratory Flammability Classification 94V-0
- ◆ For surface mounted applications
- ◆ Low reverse leakage
- ◆ Built-in strain relief, ideal for automated placement
- ◆ High forward surge current capability
- ◆ High temperature soldering guaranteed: 250°C/10 seconds at terminals
- ◆ Glass passivated chip junction

MECHANICAL DATA

Case : JEDEC DO-214AB molded plastic body over passivated chip
Terminals : Solder plated, solderable per MIL-STD-750, Method 2026
Polarity : Color band denotes cathode end
Mounting Position : Any
Weight : 0.007 ounce, 0.25grams

MAXIMUM RATINGS AND ELECTRICAL CHARACTERISTICS

Ratings at 25°C ambient temperature unless otherwise specified.

Single phase half-wave 60Hz, resistive or inductive load, for capacitive load current derate by 20%.

MDD Catalog Number	SYMBOLS	US8A	US8B	US8D	US8G	US8J	US8K	US8M	UNITS
Marking code		MDD US8A	MDD US8B	MDD US8D	MDD US8G	MDD US8J	MDD US8K	MDD US8M	
Maximum repetitive peak reverse voltage	V_{RRM}	50	100	200	400	600	800	1000	VOLTS
Maximum RMS voltage	V_{RMS}	35	70	140	280	420	560	700	VOLTS
Maximum DC blocking voltage	V_{DC}	50	100	200	400	600	800	1000	VOLTS
Maximum average forward rectified current at $T_L=55^\circ\text{C}$	$I_{(AV)}$	8.0							Amps
Peak forward surge current 8.3ms single half sine-wave superimposed on rated load (JEDEC Method)	I_{FSM}	150.0							Amps
Maximum instantaneous forward voltage at 5.0A	V_F	1.0		1.4	1.7			Volts	
Maximum DC reverse current $T_A=25^\circ\text{C}$ at rated DC blocking voltage $T_A=100^\circ\text{C}$	I_R	10.0 100.0							μA
Maximum reverse recovery time (NOTE 1)	t_{rr}	50				80			ns
Typical junction capacitance (NOTE 2)	C_J	65				55			pF
Typical thermal resistance (NOTE 3)	$R_{\theta JA}$	35.0							$^\circ\text{C}/\text{W}$
Operating junction and storage temperature range	T_J, T_{STG}	-50 to +150							$^\circ\text{C}$

- Note:** 1. Reverse recovery condition $I_F=0.5\text{A}, I_R=1.0\text{A}, I_{rr}=0.25\text{A}$
 2. Measured at 1MHz and applied reverse voltage of 4.0V D.C.
 3. P.C.B. mounted with 0.2x0.2" (5.0x5.0mm) copper pad areas



RATINGS AND CHARACTERISTIC CURVES US8A THRU US8M

Fig.1 Reverse Recovery Time Characteristic And Test Circuit Diagram

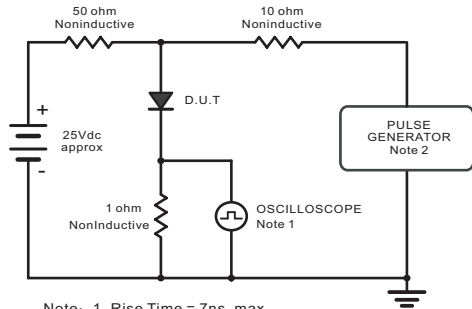

Note: 1. Rise Time = 7ns, max.
Input Impedance = 1megohm, 22pF.
2. Rise Time = 10ns, max.
Source Impedance = 50 ohms.

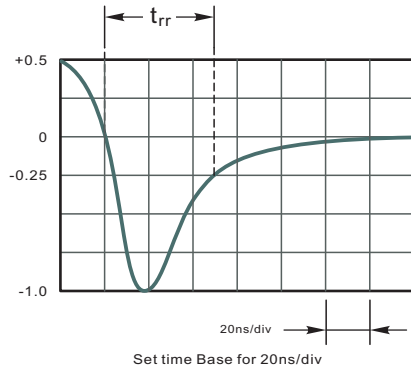

Fig.2 Maximum Average Forward Current Rating

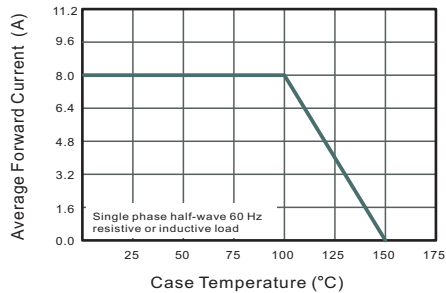

Fig.3 Typical Reverse Characteristics

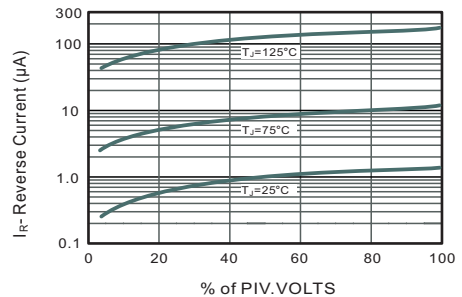

Fig.4 Typical Forward Characteristics

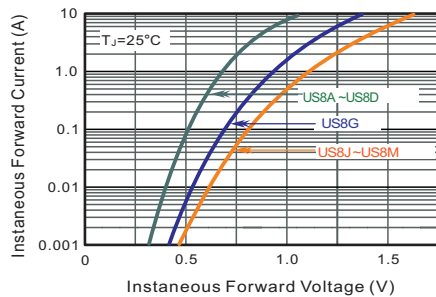

Fig.5 Typical Junction Capacitance

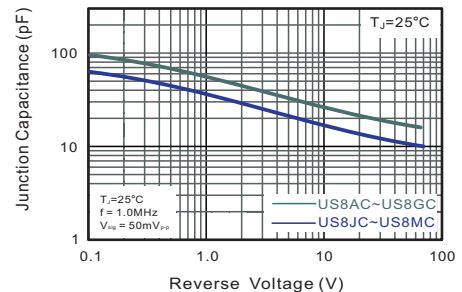
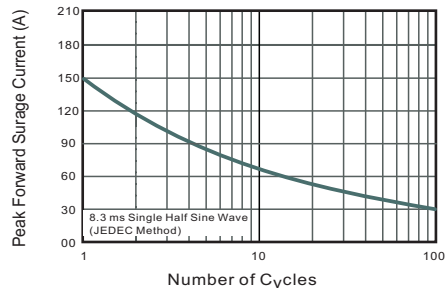

Fig.6 Maximum Non-Repetitive Peak Forward Surge Current



The curve graph is for reference only, can't be the basis for judgment (曲线图仅供参考!)

