



HJ41C

NPN EPITAXIAL PLANAR TRANSISTOR

Description

The HJ41C is designed for use in general purpose amplifier and switching applications.

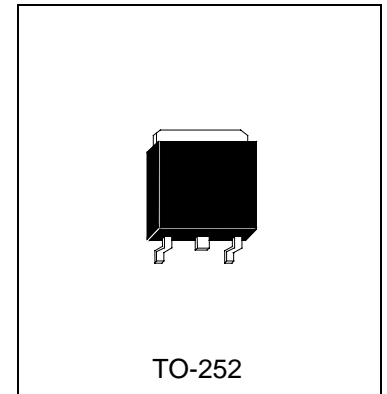

Absolute Maximum Ratings (Ta=25°C)

- Maximum Temperatures
 - Storage Temperature -55 ~ +150 °C
 - Junction Temperature +150 °C
- Maximum Power Dissipation
 - Total Power Dissipation (Tc=25°C) 20 W
- Maximum Voltages and Currents
 - BVCBO Collector to Base Voltage 100 V
 - BVCEO Collector to Emitter Voltage 100 V
 - BVEBO Emitter to Base Voltage 5 V
 - IC Collector Current 6 A

Characteristics (Ta=25°C)

Symbol	Min.	Typ.	Max.	Unit	Test Conditions
BVCBO	100	-	-	V	IC=1mA, IE=0
BVCEO	100	-	-	V	IC=30mA, IB=0
BVEBO	5	-	-	V	IC=1mA, IC=0
ICES	-	-	10	uA	VCE=100V, VEB=0
ICEO	-	-	50	uA	VCE=60V, IB=0
IEBO	-	-	500	uA	VEB=5V, IC=0
*VCE(sat)	-	-	1.5	V	IC=6A, IB=600mA
VBE(on)	-	-	2	V	VCE=4V, IC=6A
*hFE1	30	-	-		VCE=4V, IC=300mA
*hFE2	15	-	75		VCE=4V, IC=3A
fT	3	-	-	MHz	VCE=10V, IC=500mA, f=1MHz

*Pulse Test: Pulse Width ≤380us, Duty Cycle≤2%



Characteristics Curve

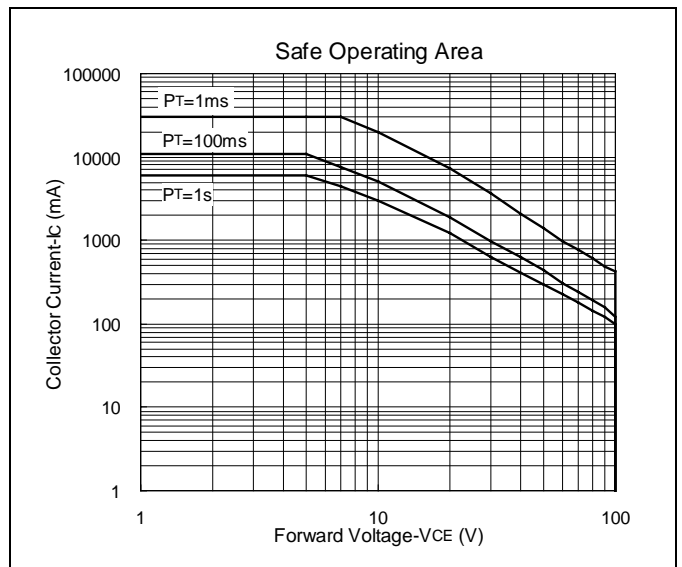
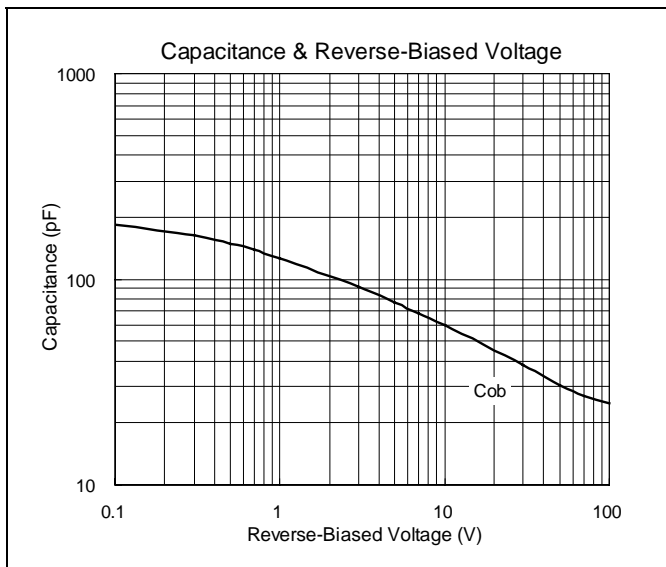
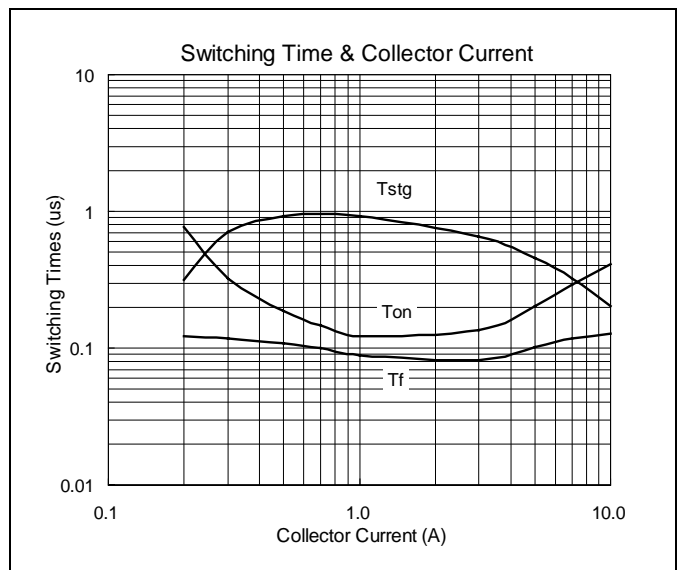
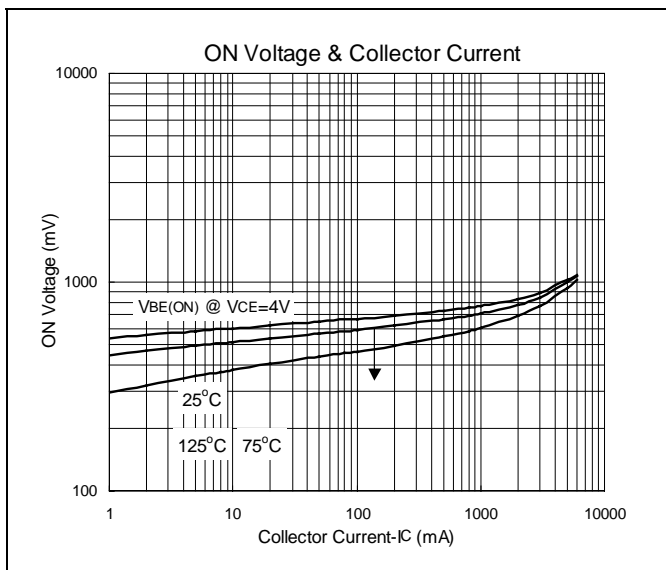
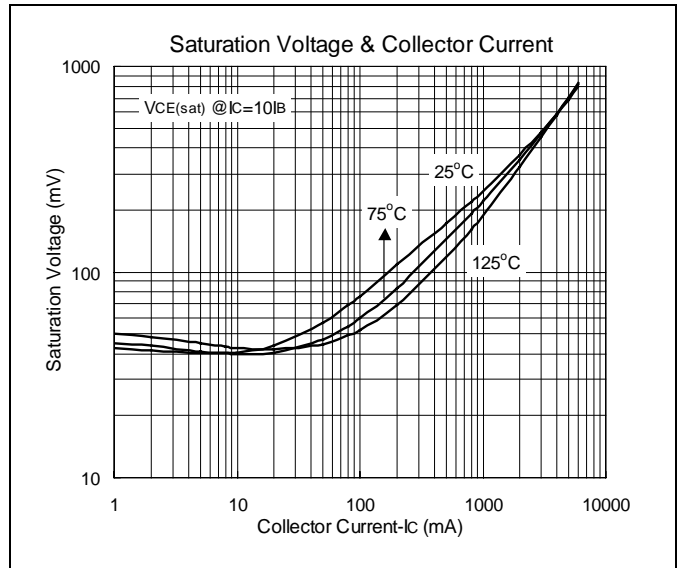
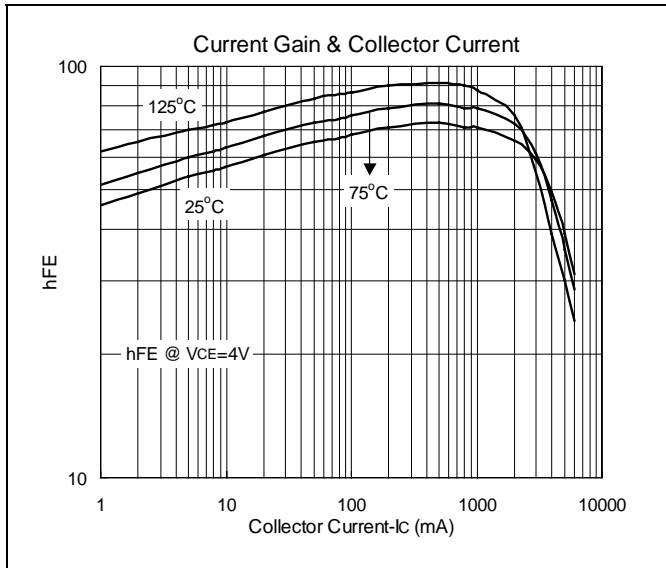



TO-252 Dimension

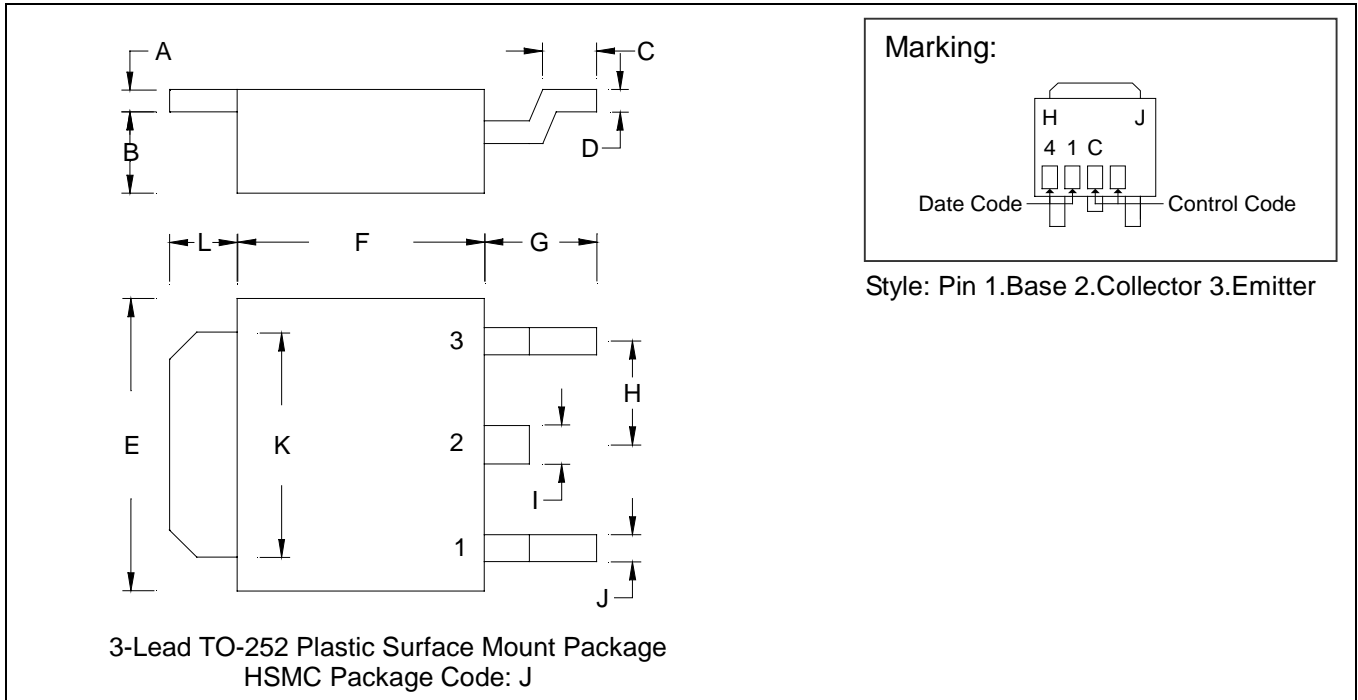

*: Typical

DIM	Inches		Millimeters		DIM	Inches		Millimeters	
	Min.	Max.	Min.	Max.		Min.	Max.	Min.	Max.
A	0.0177	0.0217	0.45	0.55	G	0.0866	0.1102	2.20	2.80
B	0.0650	0.0768	1.65	1.95	H	-	*0.0906	-	*2.30
C	0.0354	0.0591	0.90	1.50	I	-	0.0354	-	0.90
D	0.0177	0.0236	0.45	0.60	J	-	0.0315	-	0.80
E	0.2520	0.2677	6.40	6.80	K	0.2047	0.2165	5.20	5.50
F	0.2125	0.2283	5.40	5.80	L	0.0551	0.0630	1.40	1.60

- Notes: 1.Dimension and tolerance based on our Spec. dated May. 05,1996.
 2.Controlling dimension: millimeters.
 3.Maximum lead thickness includes lead finish thickness, and minimum lead thickness is the minimum thickness of base material.
 4.If there is any question with packing specification or packing method, please contact your local HSMC sales office.

Material:

- Lead: 42 Alloy; solder plating
- Mold Compound: Epoxy resin family, flammability solid burning class: UL94V-0

Important Notice:

- All rights are reserved. Reproduction in whole or in part is prohibited without the prior written approval of HSMC.
- HSMC reserves the right to make changes to its products without notice.
- **HSMC semiconductor products are not warranted to be suitable for use in Life-Support Applications, or systems.**
- HSMC assumes no liability for any consequence of customer product design, infringement of patents, or application assistance.

Head Office And Factory:

- **Head Office** (Hi-Sincerity Microelectronics Corp.): 10F.,No. 61, Sec. 2, Chung-Shan N. Rd. Taipei Taiwan R.O.C.
 Tel: 886-2-25212056 Fax: 886-2-25632712, 25368454
- **Factory 1:** No. 38, Kuang Fu S. Rd., Fu-Kou Hsin-Chu Industrial Park Hsin-Chu Taiwan. R.O.C
 Tel: 886-3-5983621~5 Fax: 886-3-5982931