

# ACMD-6003

## UMTS Band 3 Duplexer

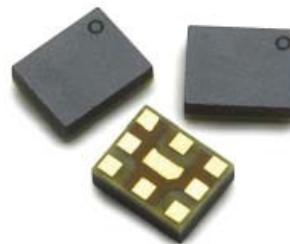

### Data Sheet



#### Description

The Avago ACMD-6003 is a highly miniaturized duplexer designed for use in UMTS Band 3 (1710 – 1785 MHz UL, 1805 – 1880 MHz DL) handsets and mobile data terminals.

Low Insertion Loss in the Tx channel minimizes current drain from the power amplifier, while low Rx channel Insertion Loss improves receiver sensitivity.

The ACMD-6003 enhances the sensitivity and dynamic range of handset receivers by providing high isolation of the transmitted signal from the receiver input and high rejection of transmit-generated noise in the receive band.

The ACMD-6003 is designed with Avago Technologies' innovative Film Bulk Acoustic Resonator (FBAR) technology, which makes possible ultra-small, high-Q filters at a fraction of their usual size. The excellent power handling capability of FBAR bulk-mode resonators supports the high output power levels used in mobile communications applications, while adding virtually no distortion.

The ACMD-6003 also utilizes Avago Technologies' advanced Microcap bonded-wafer, chip scale packaging technology. This process allows the filters to be assembled into a molded chip-on-board module with an overall maximum size of only 2.0 x 2.5 mm and maximum height of 0.95 mm. The ACMD-6003 is compatible with standard 2.0 x 2.5 mm duplexer PCB footprints.

#### Functional Block Diagram

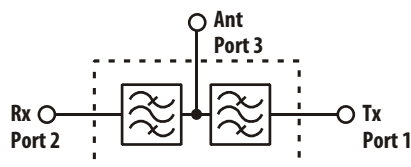

#### Features

- Miniature Size
  - 2.0 x 2.5 mm Max Size
  - 0.95 mm Max Height
  - Standard 2 x 2.5 mm PCB footprint
- High Isolation
- High Power Rating
- 33 dBm Abs Max Tx Power
- Environmental
  - RoHS 6 Compliant
  - Halogen free
  - TBBPA Free

#### Specifications

- Rx Band Performance, -20 to +85° C
  - Insertion Loss: 4.0 dB Max
  - Rx Noise Blocking: 48 dB Min
- Tx Band Performance, -20 to +85° C
  - Insertion Loss: 3.5 dB Max
  - Tx Interferer Blocking: 55 dB Min

#### Applications

UMTS Handsets or data terminals operating in the Band 3 frequency range.

ACMD-6003 Electrical Specifications<sup>[2]</sup>,  $Z_0 = 50 \Omega$ ,  $T_C$ <sup>[1]</sup> as indicated.

Symbol	Parameter	Units	-20° C		+25° C			+85° C	
			Min	Max	Min	Typ <sup>[3]</sup>	Max	Min	Max
<b>Antenna Port to Receive Port</b>									
S23	Insertion Loss in Rx Band	dB							
	1805 – 1808 MHz			4.0		2.8	3.8		3.8
	1808 – 1877 MHz			3.4		1.5	3.2		3.4
	1877 – 1880 MHz			3.1		2.9	3.1		4.0
S23	Insertion Loss, Average 3.84 MHz Channels within Rx Band (1805 – 1880 MHz)	dB		3.3		1.6	3.2		3.4
S23	Insertion Loss, Average 10 MHz Channels within Rx Band (1805 – 1880 MHz)	dB		3.0		1.6	2.9		3.2
$\Delta$ S23	Flatness, any 5 MHz within Rx Band (1805 – 1880 MHz) dB	dB		1.0			1.0		1.0
S23	Attenuation, 10 – 1710 MHz	dB	30		30	41		30	
S23	Attenuation in Tx Band (1710 – 1785 MHz)	dB	45		45	60		45	
S23	Attenuation, 1965 – 2400 MHz	dB	25		25	48		25	
S23	Attenuation in ISM 2.4 GHz Band (2400 – 2484 MHz)	dB	30		30	54		30	
S23	Attenuation, 2484 – 4000 MHz (unless otherwise specified)	dB	30		30	57		30	
S23	Attenuation, 3515 – 3665 MHz	dB	25		25	64		25	
S23	Attenuation, 5225 – 5450 MHz	dB	10		10	15		10	
S22	Return Loss (SWR) of Rx Port in Rx Band (1805 – 1880 MHz)	dB	9.0	(2.1)	9.0	24 (1.1)	(2.1)	9.0	(2.1)
<b>Transmit Port to Antenna Port</b>									
S31	Insertion Loss in Tx Band	dB							
	1710 – 1713 MHz			3.5		2.2	3.0		3.0
	1713 – 1782 MHz			2.7		1.6	2.5		2.9
	1782 – 1785 MHz			2.7		1.8	2.7		3.5
S31	Insertion Loss, Average 3.84 MHz Channels within Tx Band (1710 – 1785 MHz)	dB		2.6		1.6	2.4		2.9
S31	Insertion Loss, Average 10 MHz Channels within Tx Band (1710 – 1785 MHz)	dB		2.3		1.6	2.2		2.5
$\Delta$ S31	Flatness, any 5 MHz within Tx Band (1710 – 1785 MHz)	dB		1.0			1.0		1.0
$\Delta$ S31	Flatness, any 10 MHz within Tx Band (1710 – 1785 MHz)	dB		2.0			2.0		2.0
S31	Attenuation, 10 – 1565.4 MHz	dB	30		30	43		30	
S31	Attenuation in GPS Bands (1565.4 – 1585.4 MHz)	dB	38		38	44		38	
S31	Attenuation in GLONASS Band (1597.6 – 1605.9 MHz)	dB	35		35	40		35	
S31	Attenuation, 1605.9 – 1680.0 MHz	dB	30		30	40		30	

**ACMD-6003 Electrical Specifications <sup>[2]</sup>,  $Z_0 = 50 \Omega$ ,  $T_C$  <sup>[1]</sup> as indicated.**

Symbol	Parameter	Units	-20° C		+25° C			+85° C	
			Min	Max	Min	Typ <sup>[3]</sup>	Max	Min	Max
<b>Transmit Port to Antenna Port (cont)</b>									
S31	Attenuation in Rx Band (1805 – 1880 MHz)	dB	44		44	60		44	
S31	Attenuation, 1884.5 – 1916.6 MHz	dB	40		40	62		40	
S31	Attenuation in Band 1 Rx (2110 – 2170 MHz)	dB	30		30	47		30	
S31	Attenuation in ISM 2.4 GHz Band (2400 – 2500 MHz)	dB	30		30	32		30	
S31	Attenuation in Band 7 Rx (2620 – 2690 MHz)	dB	28		28	31		28	
S31	Attenuation in Tx 2 <sup>nd</sup> Harmonic Band (3420 – 3570 MHz)	dB	23		23	27		23	
S31	Attenuation in Tx 3 <sup>rd</sup> Harmonic Band (5130 – 5355 MHz)	dB	–			8		–	
S31	Attenuation, 5725 – 5850 MHz	dB	–			11		–	
S31	Attenuation in Tx 4 <sup>th</sup> Harmonic Band (6840 – 7140 MHz)	dB	–			14		–	
S11	Return Loss (SWR) of Tx Port in Tx Band (1710 – 1785 MHz) dB	dB	9.0	(2.1)	9.0	15 (1.4)	(2.1)	9.0	(2.1)
<b>Antenna Port</b>									
S33	Return Loss (SWR) of Ant Port in Rx Band (1805 – 1880 MHz)	dB	9.5	(2.0)	9.5	23 (1.2)	(2.0)	9.5	(2.0)
S33	Return Loss (SWR) of Ant Port in Tx Band (1710 – 1785 MHz)	dB	9.5	(2.0)	9.5	17 (1.3)	(2.0)	9.5	(2.0)
<b>Isolation, Tx Port to Rx Port</b>									
S21	Tx-Rx Isolation in Receive Band (1805 – 1880 MHz)	dB	48		48	62		48	
S21	Tx-Rx Isolation in Receive Band, Average 10 MHz Channels (1805 – 1880 MHz)	dB	50		50			50	
S21	Tx-Rx Isolation in Transmit Band (1710 – 1785 MHz)	dB	55		55	60		55	
S21	Tx-Rx Isolation in Transmit Band, Average 10 MHz Channels (1710 – 1785 MHz)	dB	55		55			55	

Notes:

1.  $T_C$  is the case temperature and is defined as the temperature of the underside of the Duplexer where it makes contact with the circuit board.
2. Min/Max specifications are guaranteed at the indicated temperature with the input power to the Tx port equal to or less than +29 dBm over all Tx frequencies unless otherwise noted.
3. Typical data is the average value of the parameter over the indicated band at the specified temperature. Typical values may vary over time.

## ACMD-6003

### Absolute Maximum Ratings <sup>[1]</sup>

Parameter	Unit	Value
Storage temperature	°C	-65 to +125
Maximum RF Input Power to Tx Port	dBm	+33

### Maximum Recommended Operating Conditions <sup>[2]</sup>

Parameter	Unit	Value
Operating temperature, $T_C$ <sup>[3]</sup> , Tx Power $\leq$ 29 dBm, CW	°C	-40 to +100
Operating temperature, $T_C$ <sup>[3]</sup> , Tx Power $\leq$ 30 dBm, CW	°C	-40 to +85

Notes:

1. Operation in excess of any one of these conditions may result in permanent damage to the device.
2. The device will function over the recommended range without degradation in reliability or permanent change in performance, but is not guaranteed to meet electrical specifications.
3.  $T_C$  is defined as case temperature, the temperature of the underside of the duplexer where it makes contact with the circuit board.

### ACMD-6003 Typical Performance at $T_c = 25^\circ\text{C}$

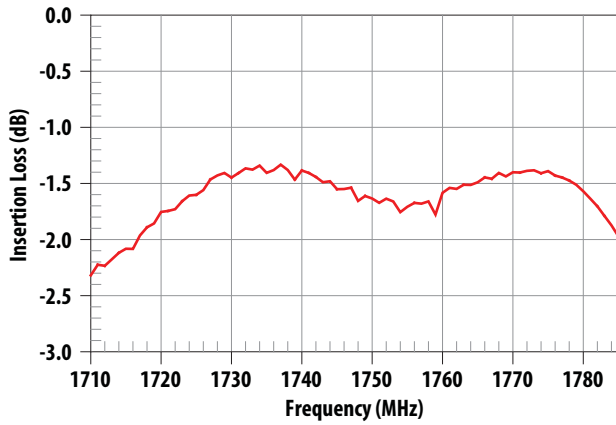

Figure 1. Tx-Ant Insertion Loss

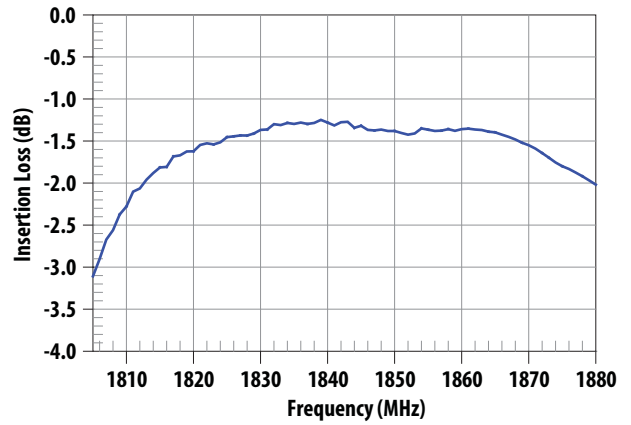

Figure 2. Ant-Rx Insertion Loss

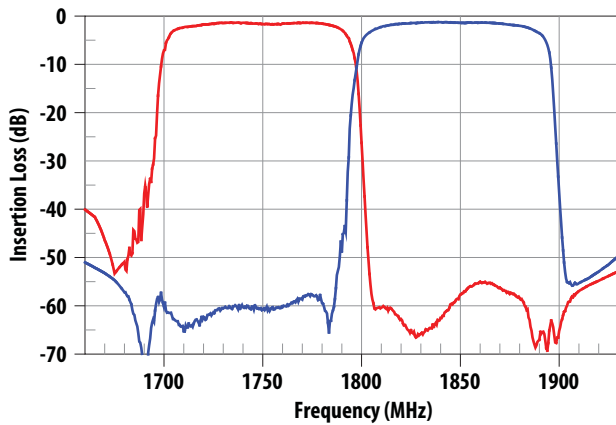

Figure 3. Tx Rejection in Rx Band and Rx Rejection in Tx Band

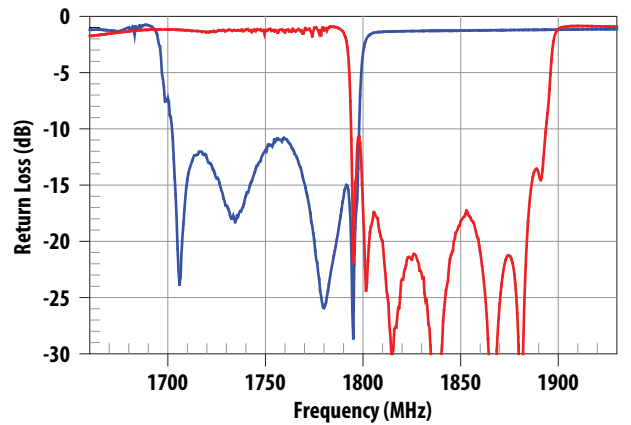

Figure 4. Tx and Rx Port Return Loss

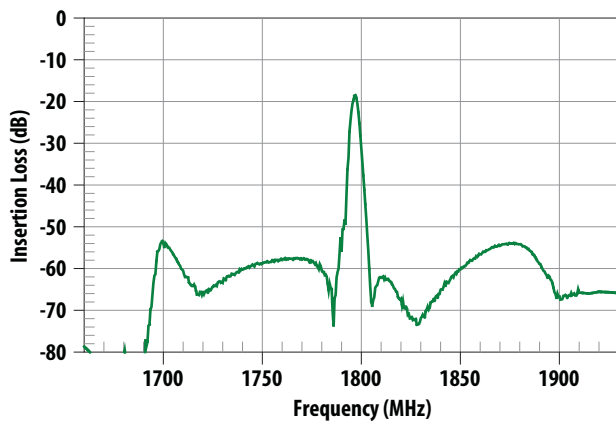

Figure 5. Tx-Rx Isolation

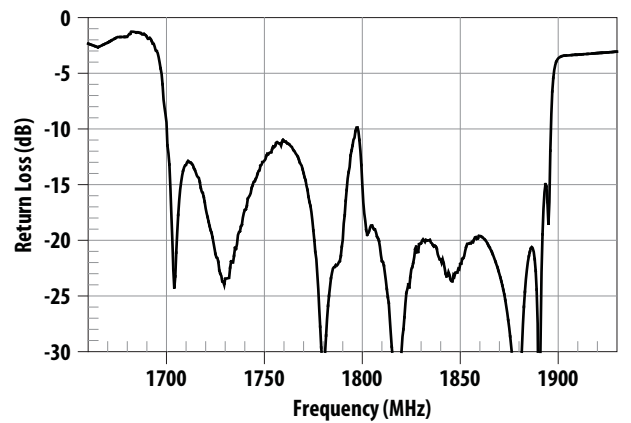

Figure 6. Antenna Port Return Loss

**ACMD-6003 Typical Performance at Tc = 25° C**

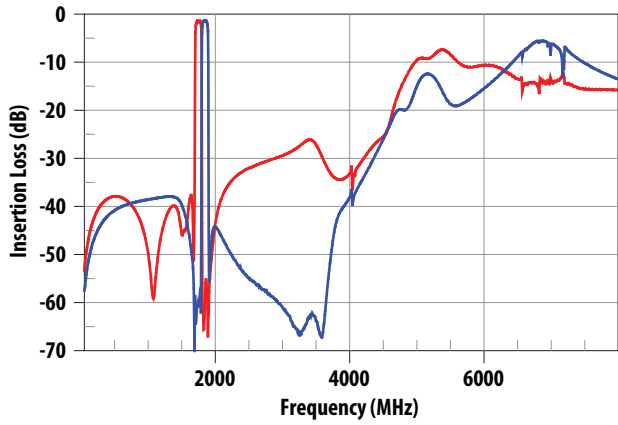

Figure 7. Tx-Ant and Ant-Rx Wideband Insertion Loss

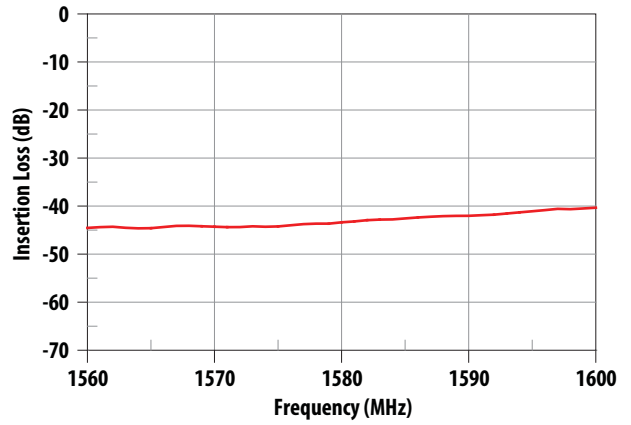

Figure 8. Tx-Ant Rejection in GPS/GLONASS Bands

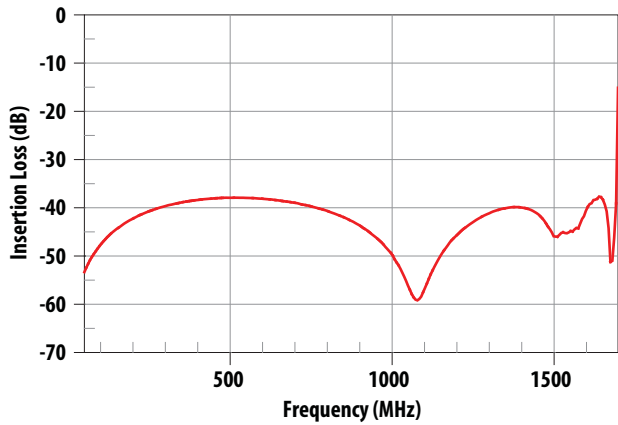

Figure 9. Tx-Ant Low Frequency Rejection, 50 - 1700 MHz.

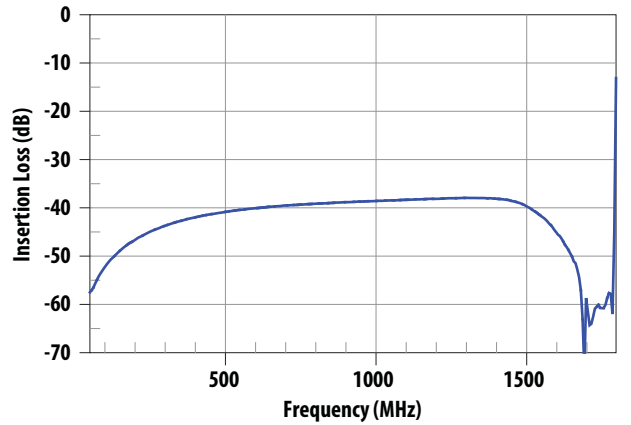

Figure 10. Ant-Rx Low Frequency Rejection, 50 - 1800 MHz

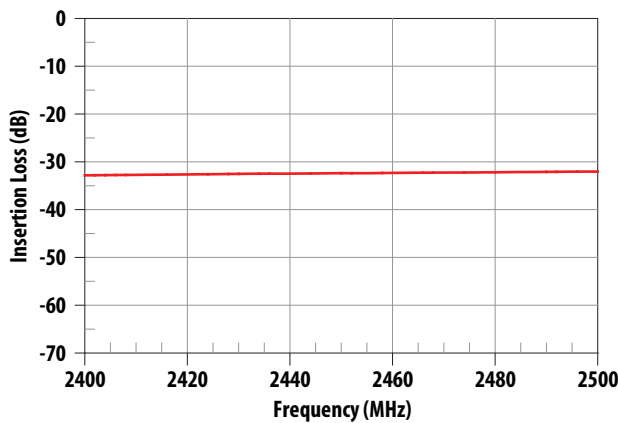

Figure 11. Tx-Ant Rejection, 2.4 GHz ISM Band

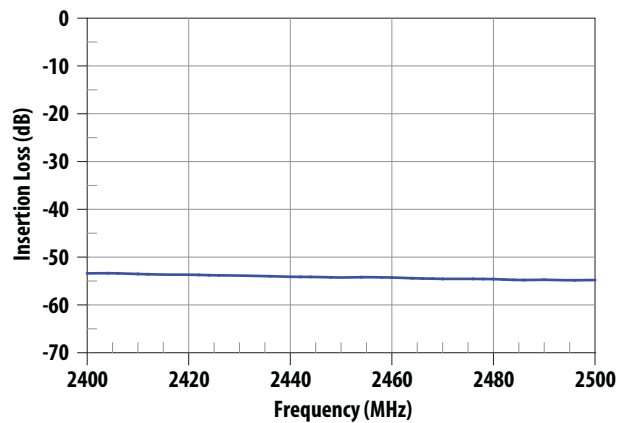

Figure 12. Ant-Rx Rejection, 2.4 GHz ISM Band

# ACMD-6003 Typical Performance at $T_c = 25^\circ\text{C}$

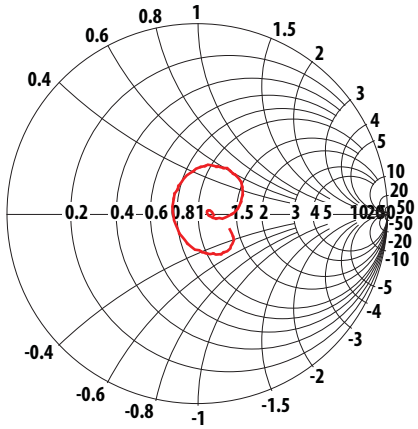

Figure 13. Tx Port Impedance in Tx Band

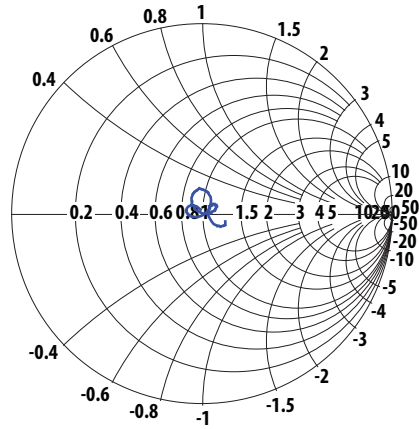

Figure 14. Rx Port Impedance in Rx Band

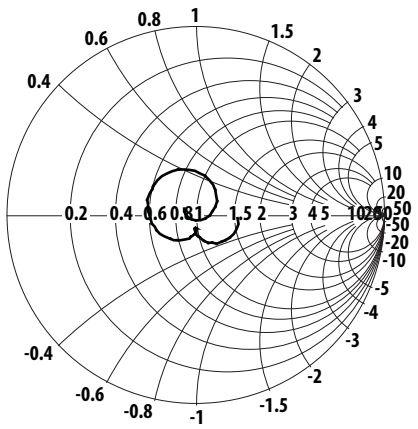

Figure 15. Ant Port Impedance in Tx Band

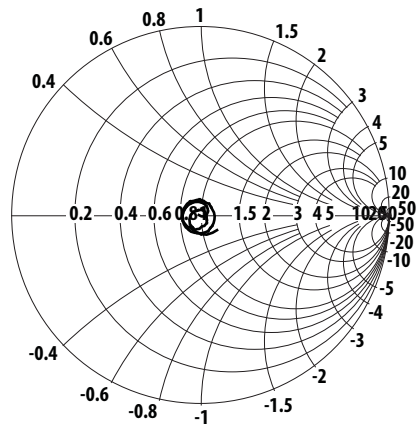
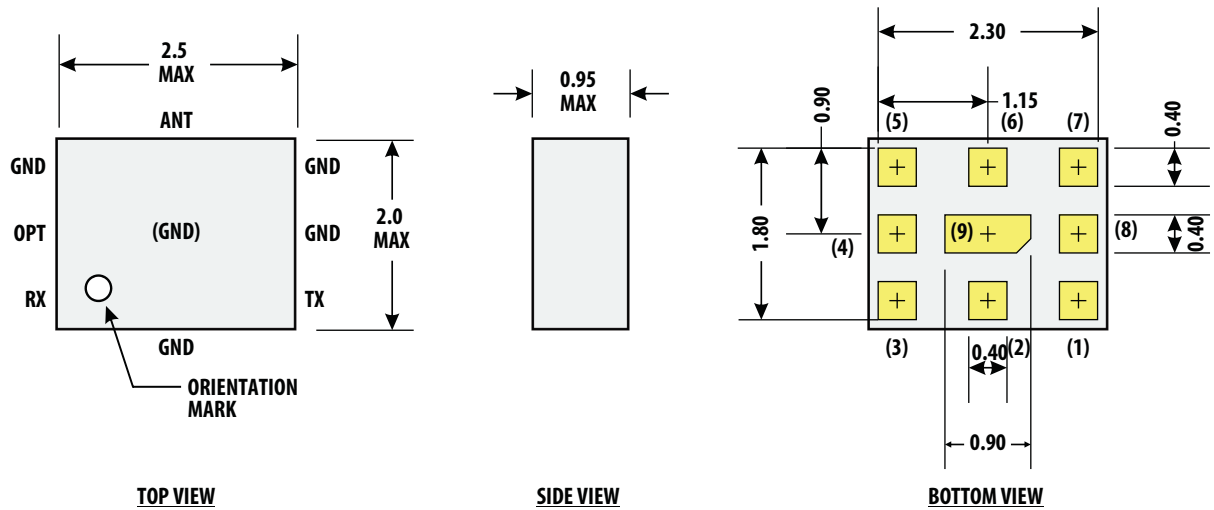

Figure 16. Ant Port Impedance in Rx Band

# ACMD-6003



**Notes:**

1. Dimensions in millimeters  
Tolerance: X.X ± 0.1 mm  
X.XX ± 0.05 mm
2. Dimensions nominal unless otherwise noted
3. Angles 45° nominal
4. I/O Pads (3 ea)  
Size: 0.40 X 0.40 mm  
Spacing to ground metal: 0.30 mm
5. Contact areas are gold plated

**Pin Connections:**

- |               |                            |
|---------------|----------------------------|
| 1             | Rx (or RX(+))              |
| 2, 4, 5, 7, 9 | Gnd                        |
| 3             | Tx                         |
| 6             | Ant                        |
| 8             | Optional: Gnd, NC or Rx(-) |

**Figure 17. Package Outline Drawing**

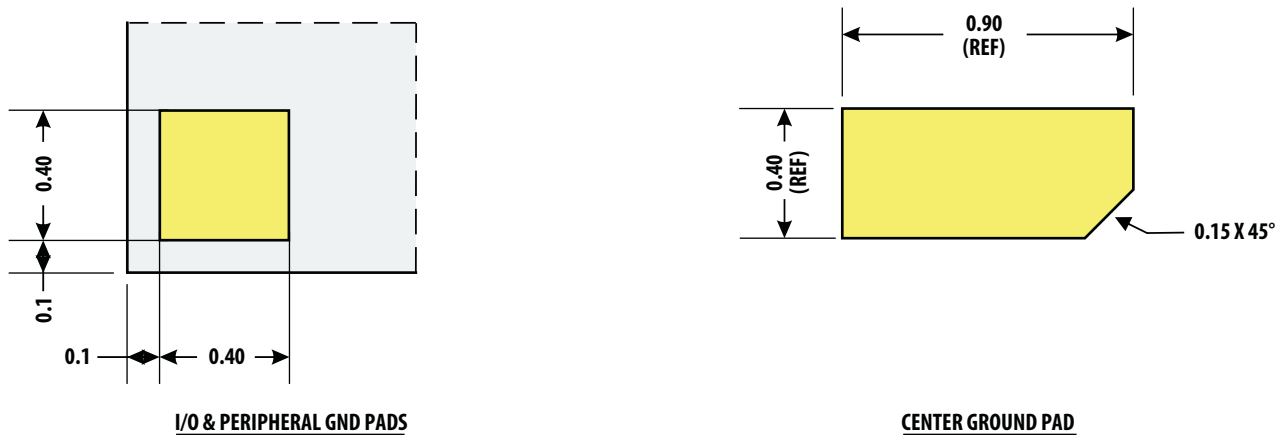

**Figure 18. Pad Detail**



**ACMD-6003**

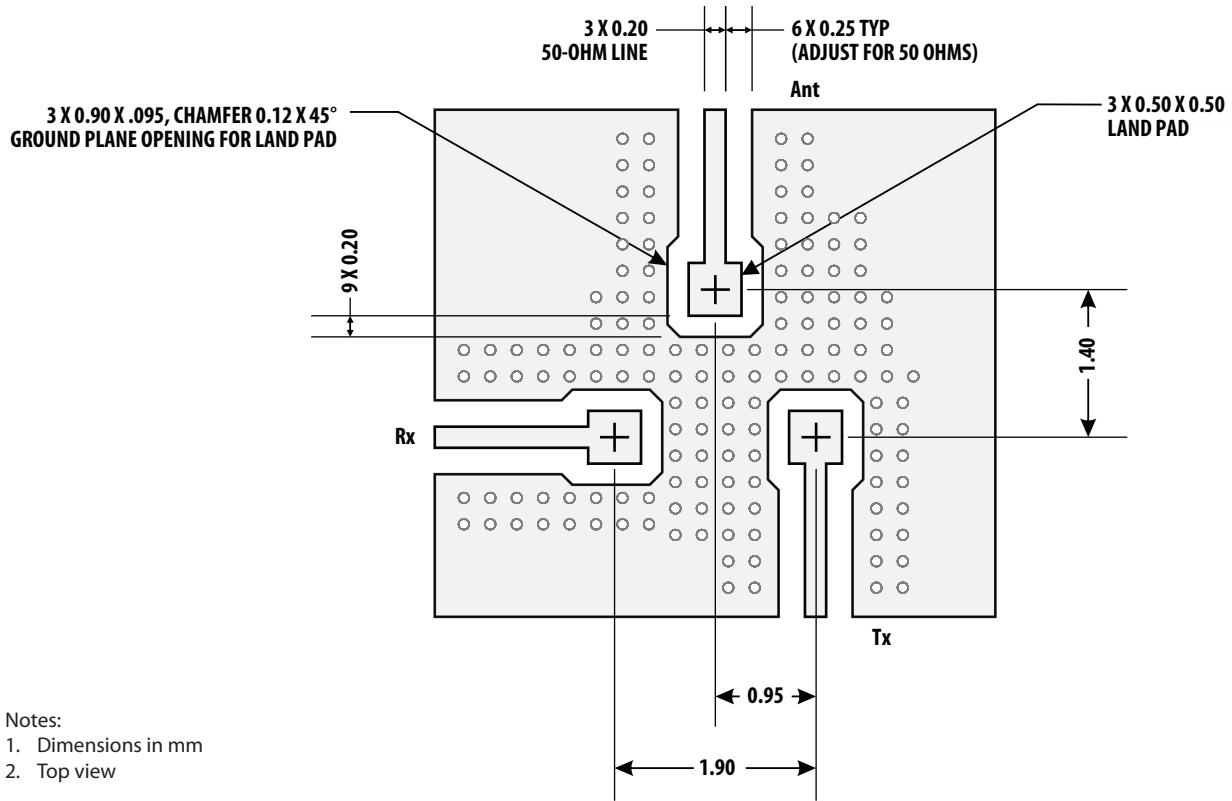

- Notes:  
 1. Dimensions in mm  
 2. Top view

**Figure 19. Suggested PCB Layout**

A PCB layout using the principles illustrated in the figure above is recommended to optimize performance of the ACMD-6003.

Note: Pin 8 (Rx-) is grounded in this example.

The transmission line dimensions shown are designed to achieve an impedance of 50 ohms for an 80 μm thick PCB layer with a dielectric constant of 3.4. If other PCB materials or thicknesses are used, the 0.25 mm gap spacing may need to be adjusted to retain a  $Z_0$  of 50 ohms.

It is important to maximize isolation between the Tx and Rx ports.

High isolation is achieved by: (1) maintaining a continuous ground plane around the I/O connections and duplexer mounting area, and (2) surrounding the I/O ports with sufficient ground vias to enclose the connections in a "Faraday cage."

The ground vias under the ACMD-6003 mounting area are also needed to provide adequate heat sinking for the device.

**ACMD-6003**

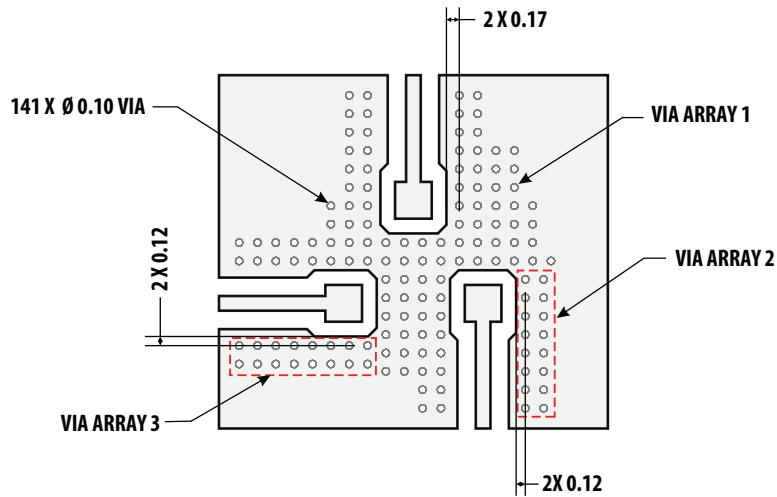

- Notes:
1. Dimensions in mm
  2. Top view
  3. Via arrays: horiz pitch = 0.25, vert pitch = 0.25

**Figure 20. PCB Layout, Via Detail**

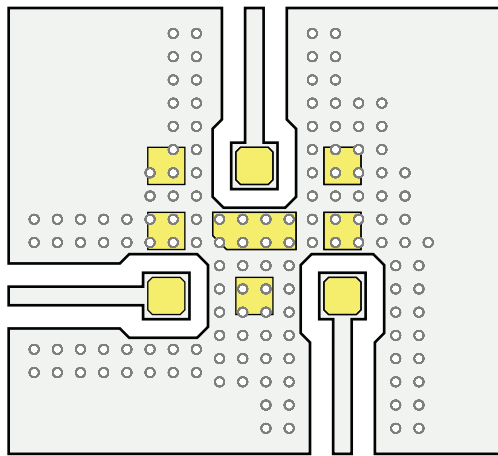

- Note:
1. Top view

**Figure 21. ACMD-6003 Foot Print Superposed on PCB Layout**

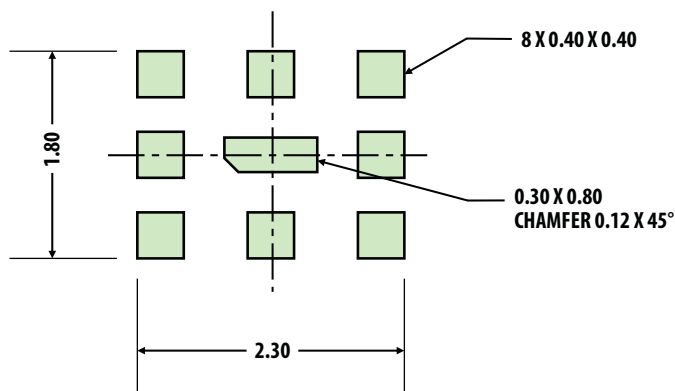

- Notes:
1. Dimensions in mm
  2. Top view
  3. Chamfer or radius all corners 0.05 mm min

**Figure 22. Recommended Solder Stencil**

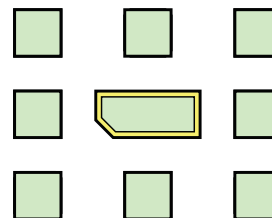

- Notes:
1. Top view
  2. Peripheral clearance of stencil aperture for center device pad is 0.05 mm. All other apertures match device pad 1:1

**Figure 23. Solder Stencil Superposed on ACMD-6003**

**ACMD-6003**

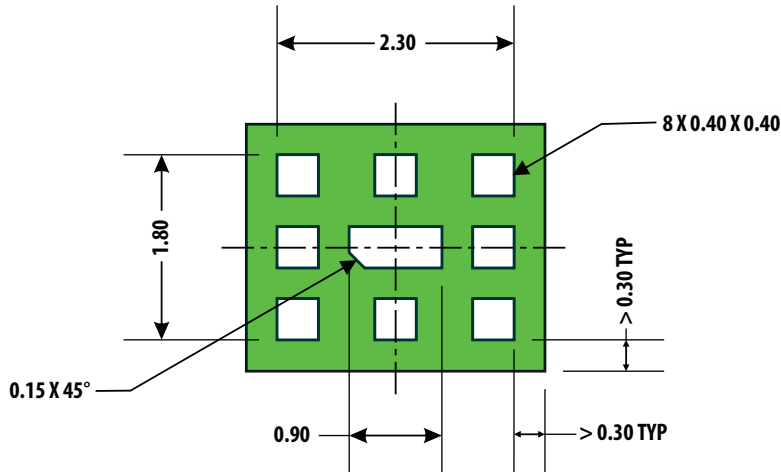

- Notes:
1. Dimensions in mm
  2. Top view

**Figure 24. Recommended Solder Mask**

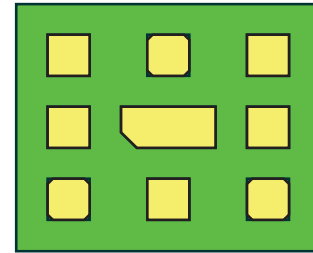

- Notes:
1. Top view
  2. Mask apertures match device pads 1:1

**Figure 25. Solder Mask Superposed on ACMD-6003 Foot Print**

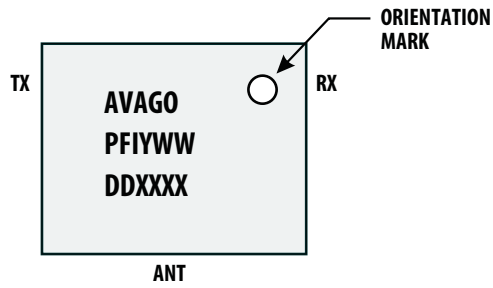

- AVAGO = Mfg (Avago Technologies, Inc.)
- P = ACMD-6003
- FI = Mfg Information
- Y = Year
- WW = Work Week
- DD = Date Code
- XXXX = Assembly Lot

**Figure 26. Product Marking and Pin Orientation**

**ACMD-6003**

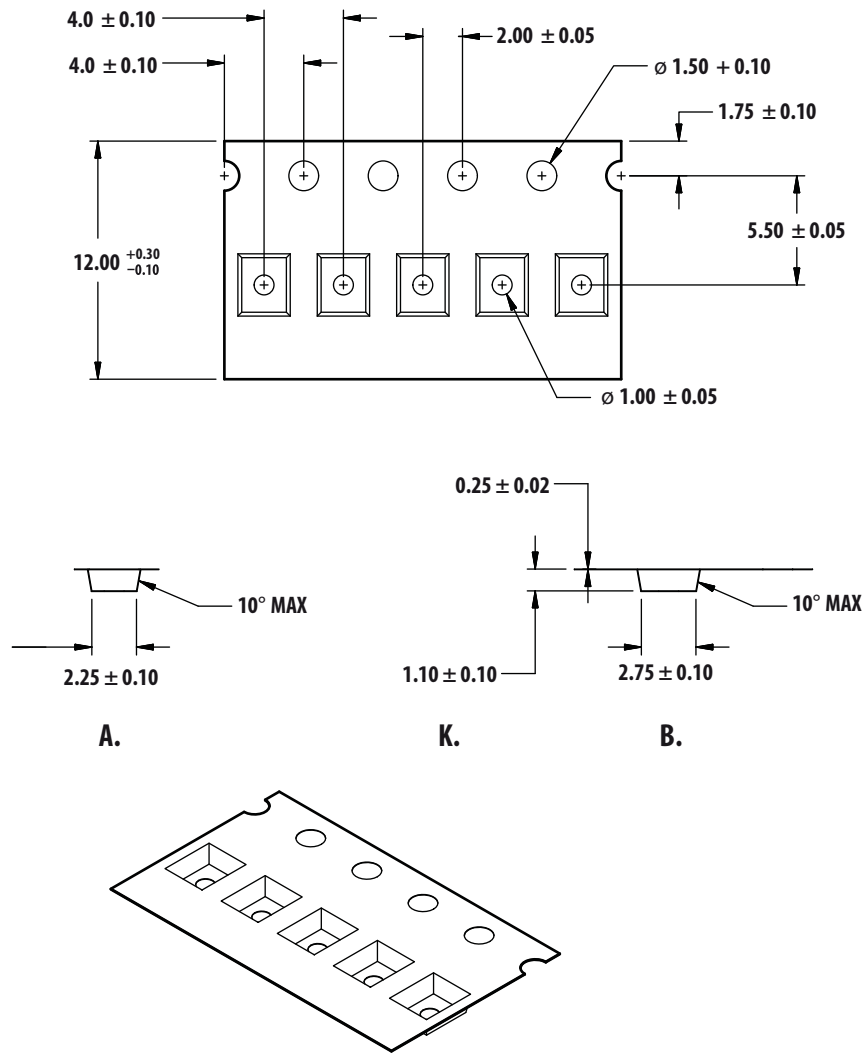

Figure 27. SMD Tape Packing (Dimensions for actual tape carrier may vary slightly)

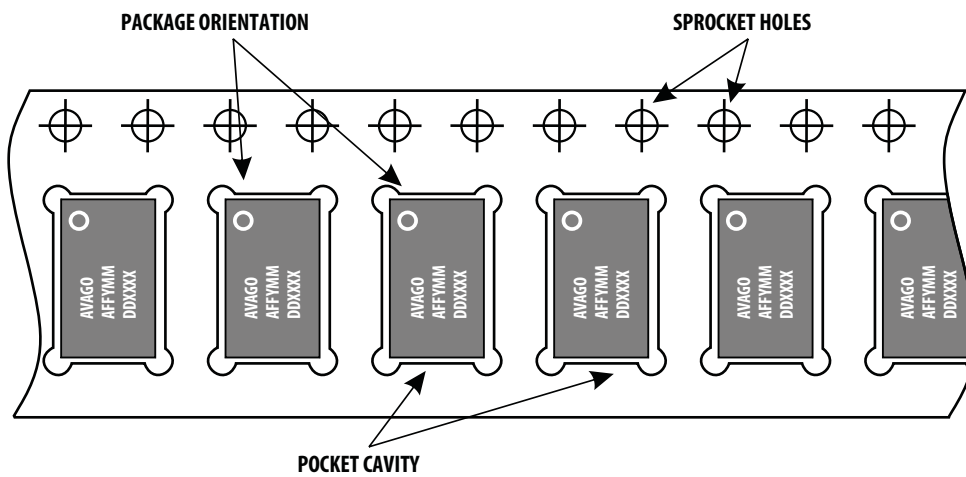
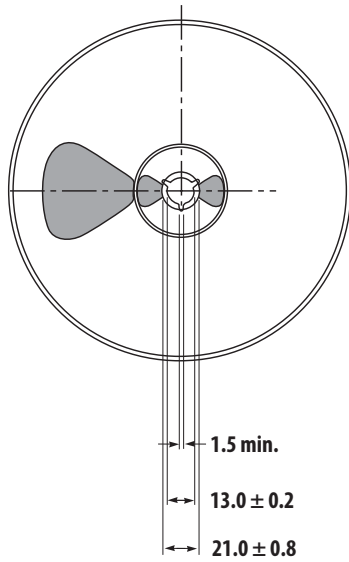

Figure 28. Unit Orientation in SMT Tape

**ACMD-6003**

**FRONT VIEW**



**NOTES:**

1. Reel shall be labeled with the following information (as a minimum).
  - a. manufacturers name or symbol
  - b. Avago Technologies part number
  - c. purchase order number
  - d. date code
  - e. quantity of units
2. A certificate of compliance (c of c) shall be issued and accompany each shipment of product.
3. Reel must not be made with or contain ozone depleting materials.
4. All dimensions in millimeters (mm)

**BACK VIEW**

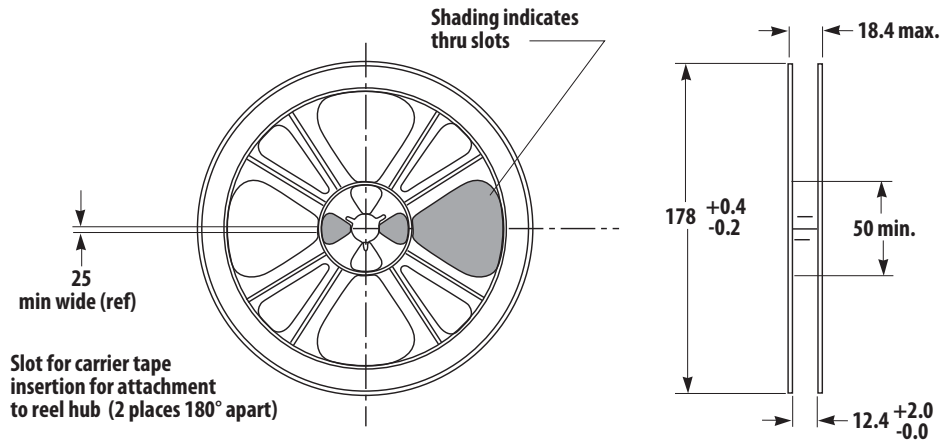

**Figure 29. SMT Reel Drawing**

## ACMD-6003

### Package Moisture Sensitivity

Feature	Test Method	Performance
Moisture Sensitivity Level (MSL) at 260° C	JESD22-A113D	Level 3

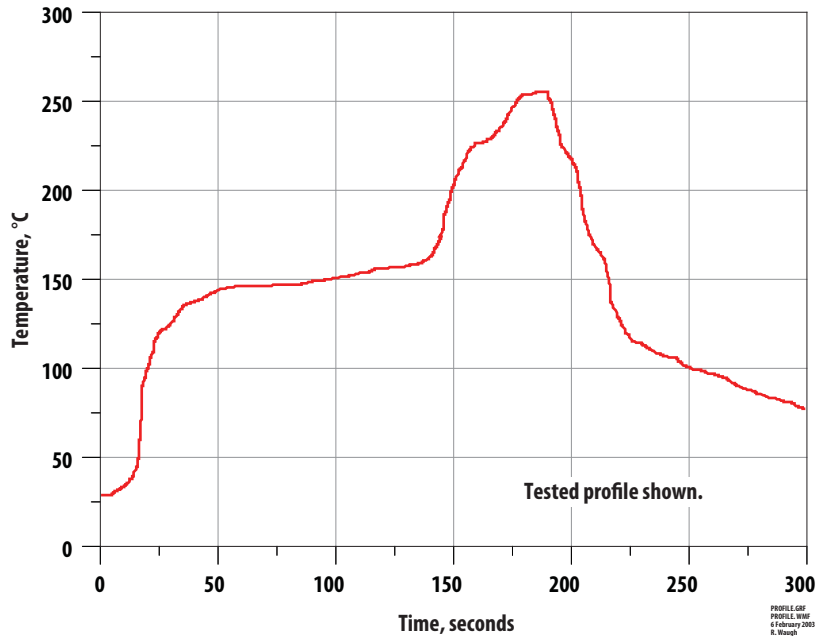

Figure 30. Verified SMT Solder Profile

### Ordering Information

Part Number	No. of Devices	Container
ACMD-6003-BLK	100	Tape Strip or Anti-static Bag
ACMD-6003-TR1	3000	178 mm (7-inch) Reel

For product information and a complete list of distributors, please go to our web site: [www.avagotech.com](http://www.avagotech.com)

Avago, Avago Technologies, and the A logo are trademarks of Avago Technologies in the United States and other countries. Data subject to change. Copyright © 2005-2011 Avago Technologies. All rights reserved.  
AV02-2922EN - April 18, 2011

**AVAGO**  
TECHNOLOGIES