

Features

- ✧ Plastic package has Underwriters Laboratory Flammability Classification 94V-0
- ✧ Exceeds environmental standards of MIL-STD-19500
- ✧ 400W surge capability at 10 x 1000 us waveform
- ✧ Excellent clamping capability
- ✧ Low impedance surge resistance
- ✧ Very fast response time
- ✧ Typical I_R less than 1uA above 10V
- ✧ High temperature soldering guaranteed:
260°C / 10 seconds
- ✧ Green compound with suffix "G" on packing code & prefix "G" on datecode

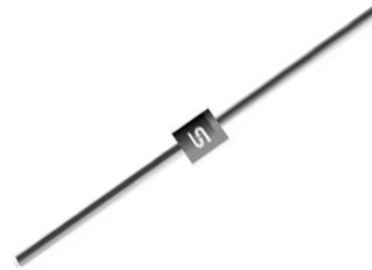

Mechanical Data

- ✧ Case: Molded plastic
- ✧ Lead: Axial leads, solderable per MIL-STD-202, Method 208
- ✧ Polarity: Color band denotes cathode except bipolar
- ✧ Weight: 0.34 gram

Ordering Information (example)

Part No.	Package	Packing	INNER TAPE	Packing code	Packing code (Green)
BZW04-10	DO-41	3K / AMMO box	52mm	A0	A0G

Maximum Ratings and Electrical Characteristics

Rating at 25 °C ambient temperature unless otherwise specified.

Parameter	Symbol	Value	Unit
Peak Pulse Power Dissipation at $T_A=25^\circ\text{C}$, $T_p=1\text{ms}$ (Note 1)	P_{PK}	Minimum 400	Watts
Steady State Power Dissipation at $T_L=75^\circ\text{C}$ Lead Lengths .375", 9.5mm (Note 2)	P_D	1	Watts
Peak Forward Surge Current, 8.3ms Single Half Sine-wave Superimposed on Rated Load (JEDEC method)(Note 3)	I_{FSM}	40	Amps
Junction to leads	$R_{\theta JL}$	60	°C/W
Junction to ambient on printed circuit L lead=10mm	$R_{\theta JA}$	100	°C/W
Operating and Storage Temperature Range	T_J, T_{STG}	-55 to +175	°C

Note 1: Non-repetitive Current Pulse, Per derated above $T_A=25^\circ\text{C}$

Note 2: Mounted on copper pad area of 0.2" x 0.2" (5 x 5mm)

Note 3: Measure on 8.3ms single half sine-wave or equivalent square wave, duty cycle=4 pulses per minute maximum.

RATINGS AND CHARACTERISTIC CURVES (BZW04 SERIES)

FIG. 1 PEAK PULSE POWER RATING CURVE

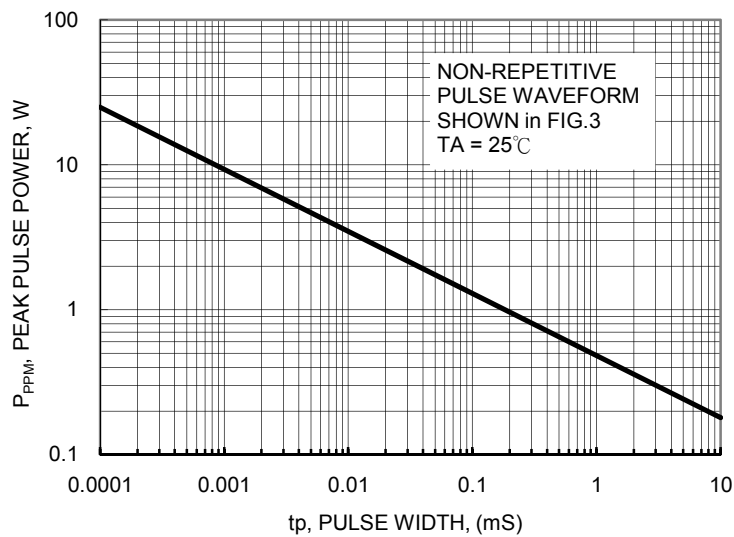

FIG.2 PULSE DERATING CURVE

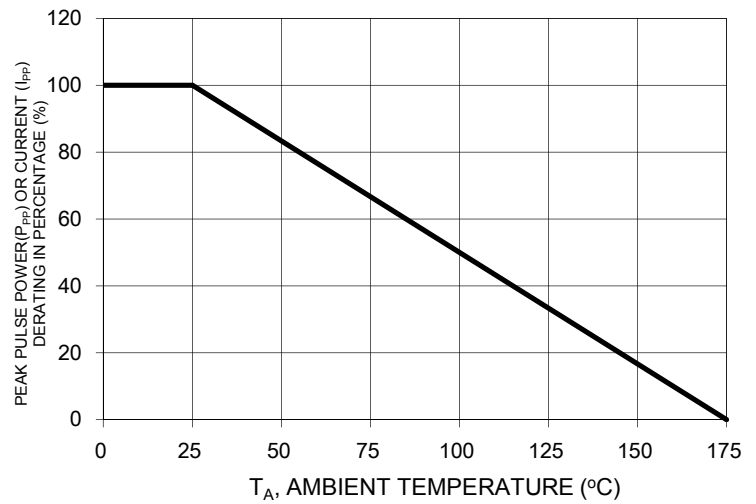

FIG. 3 CLAMPING POWER PULSE WAVEFORM

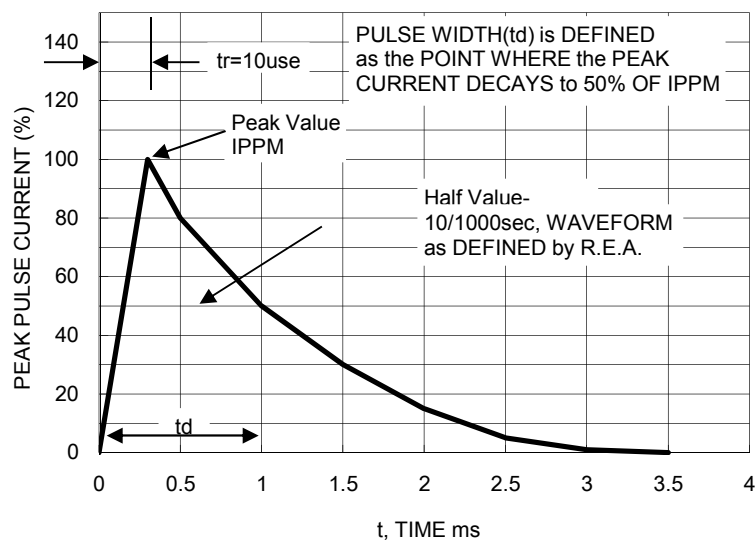

FIG.4 STEADY STATE POWER DERATING CURVE

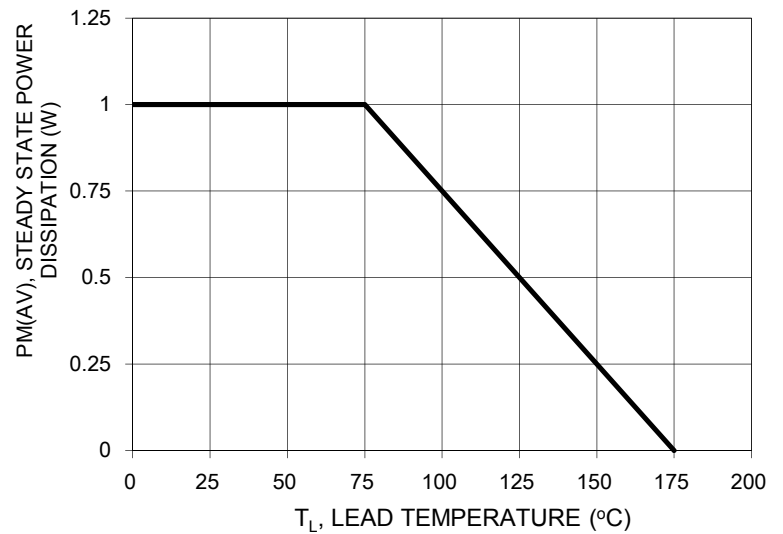
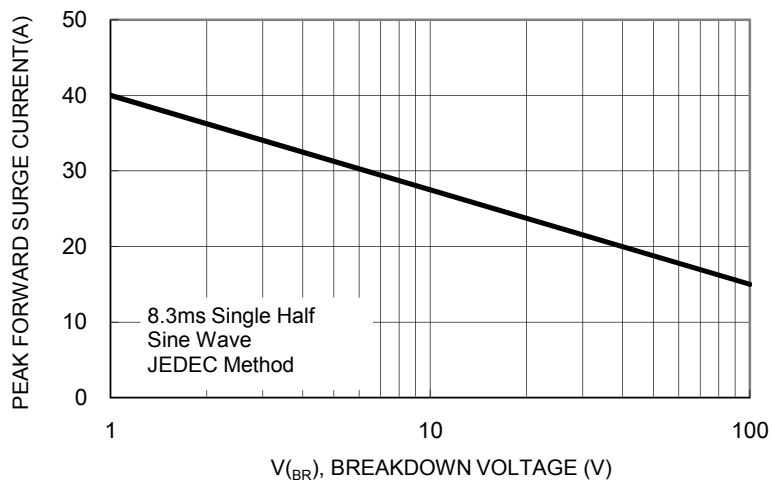

FIG. 5 MAXIMUM NON-REPETITIVE FORWARD SURGE CURRENT UNIDIRECTIONAL ONLY



RATINGS AND CHARACTERISTIC CURVES (BZW04 SERIES)

FIG. 6 TYPICAL REVERSE CHARACTERASTICS

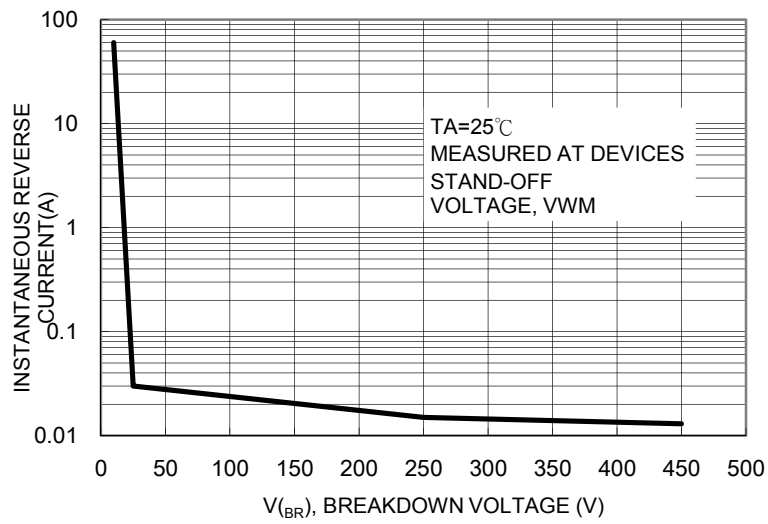
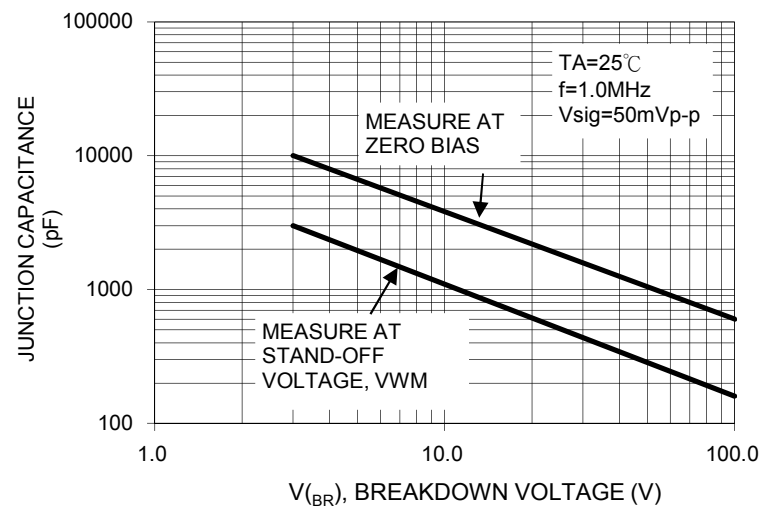

FIG.7 TYPICAL JUNCTION CAPACITANCE UNIDIRECTIONAL



ELECTRICAL CHARACTERISTICS (T_A=25°C unless otherwise noted)

Device		Breakdown Voltage @IR (Note 1)		Test Current	Stand-Off Voltage	Reverse Leakage @ V _{WM}	Maximum Peak Pulse Current	Maximum Clamping Voltage @I _{PPM}	Maximum Temperature Coefficient
		V _{BR}		I _T	V _{WM}	I _D	I _{PPM}	V _c	V _{BR}
		V		mA	V	uA	A	V	%/°C
Unidirectional	Bidirectional	Min	Max			(Note 3)			
BZW04-5V8	BZW04-5V8B	6.45	7.14	10	5.80	1000	38.0	10.5	0.057
BZW04-6V4	BZW04-6V4B	7.13	7.88	10	6.40	500	35.4	11.3	0.061
BZW04-7V0	BZW04-7V0B	7.79	8.61	10	7.02	200	33.0	12.1	0.065
BZW04-7V8	BZW04-7V8B	8.65	9.55	1	7.78	50	30.0	13.4	0.068
BZW04-8V5	BZW04-8V5B	9.5	10.5	1	8.55	10	27.6	14.5	0.073
BZW04-9V4	BZW04-9V4B	10.5	11.6	1	9.40	5	25.7	15.6	0.075
BZW04-10	BZW04-10B	11.4	12.6	1	10.2	5	24.0	16.7	0.078
BZW04-11	BZW04-11B	12.4	13.7	1	11.1	5	22.0	18.2	0.081
BZW04-13	BZW04-13B	14.3	15.8	1	12.8	5	19.0	21.2	0.084
BZW04-14	BZW04-14B	15.2	16.8	1	13.6	1	17.8	22.5	0.083
BZW04-15	BZW04-15B	17.1	18.9	1	15.3	1	16.0	25.2	0.088
BZW04-17	BZW04-17B	19.0	21.0	1	17.1	1	14.5	27.7	0.090
BZW04-19	BZW04-19B	20.9	23.1	1	18.8	1	13.0	30.6	0.092
BZW04-20	BZW04-20B	22.8	25.2	1	20.5	1	12.0	33.2	0.094
BZW04-23	BZW04-23B	25.7	28.4	1	23.1	1	10.7	37.5	0.096
BZW04-26	BZW04-26B	28.5	31.5	1	25.6	1	9.6	41.5	0.097
BZW04-28	BZW04-28B	31.4	34.7	1	28.2	1	8.8	45.7	0.098
BZW04-31	BZW04-31B	34.2	37.8	1	30.8	1	8.0	49.9	0.099
BZW04-33	BZW04-33B	37.1	41.0	1	33.3	1	7.4	53.9	0.100
BZW04-37	BZW04-37B	40.9	45.2	1	36.8	1	6.7	59.3	0.101
BZW04-40	BZW04-40B	44.7	49.4	1	40.2	1	6.2	64.8	0.101
BZW04-44	BZW04-44B	48.5	53.6	1	43.6	1	5.7	70.1	0.102
BZW04-48	BZW04-48B	53.2	58.8	1	47.8	1	5.2	77.0	0.103
BZW04-53	BZW04-53B	58.9	65.1	1	53.0	1	4.7	85.0	0.104
BZW04-58	BZW04-58B	64.6	71.4	1	58.1	1	4.3	92.0	0.104
BZW04-64	BZW04-64B	71.3	78.8	1	64.1	1	3.9	103	0.105
BZW04-70	BZW04-70B	77.9	86.1	1	70.1	1	3.5	113	0.105
BZW04-78	BZW04-78B	86.5	95.5	1	78.0	1	3.2	125	0.105
BZW04-85	BZW04-85B	95	105	1	85.5	1	2.9	137	0.106
BZW04-94	BZW04-94B	105	116	1	94.0	1	2.6	152	0.107
BZW04-102	BZW04-102B	114	126	1	102	1	2.4	165	0.107
BZW04-110	BZW04-110B	124	137	1	111	1	2.2	179	0.107
BZW04-128	BZW04-128B	143	158	1	128	1	2.0	207	0.108
BZW04-136	BZW04-136B	152	168	1	136	1	1.8	219	0.108
BZW04-145	BZW04-145B	161	179	1	145	1	1.7	234	0.108
BZW04-154	BZW04-154B	171	189	1	154	1	1.6	246	0.108
BZW04-171	BZW04-171B	190	210	1	171	1	1.5	274	0.108
BZW04-188	BZW04-188B	209	231	1	188	1	1.4	301	0.108
BZW04-213	BZW04-213B	237	263	1	213	1	1.2	344	0.110
BZW04-239	BZW04-239B	266	294	1	239	1	1.1	384	0.110
BZW04-256	BZW04-256B	285	315	1	256	1	1.0	414	0.110
BZW04-273	BZW04-273B	304	336	1	273	1	0.9	438	0.110
BZW04-299	BZW04-299B	332	368	1	299	1	0.8	482	0.110
BZW04-342	BZW04-342B	380	420	1	342	1	0.75	548	0.110
BZW04-376	BZW04-376B	418	462	1	376	1	0.67	603	0.110

Notes:

1. Pulse test : tp<50ms
2. All terms and symbols are consistent with ANSI/IEEE C62.35
3. For bipolar types having V_{WM} of 10 volts and less, the I_D limit is doubled.

Ordering information

Part No.	Package	Packing	INNER TAPE	Packing code	Packing code (Green)
BZW04-xx	DO-41	3K / AMMO box	52mm	A0	A0G
	DO-41	3K / AMMO box	26mm	A1	A1G
	DO-41	5K / 13" Reel	52mm	R0	R0G
	DO-41	5K / 13" Reel	52mm	R1	R1G
	DO-41	1K / Bulk packing		B0	B0G

Note: "xx" is Device Code from "5V8" thru "376".

AXIAL LEAD TAPING SPECIFICATIONS

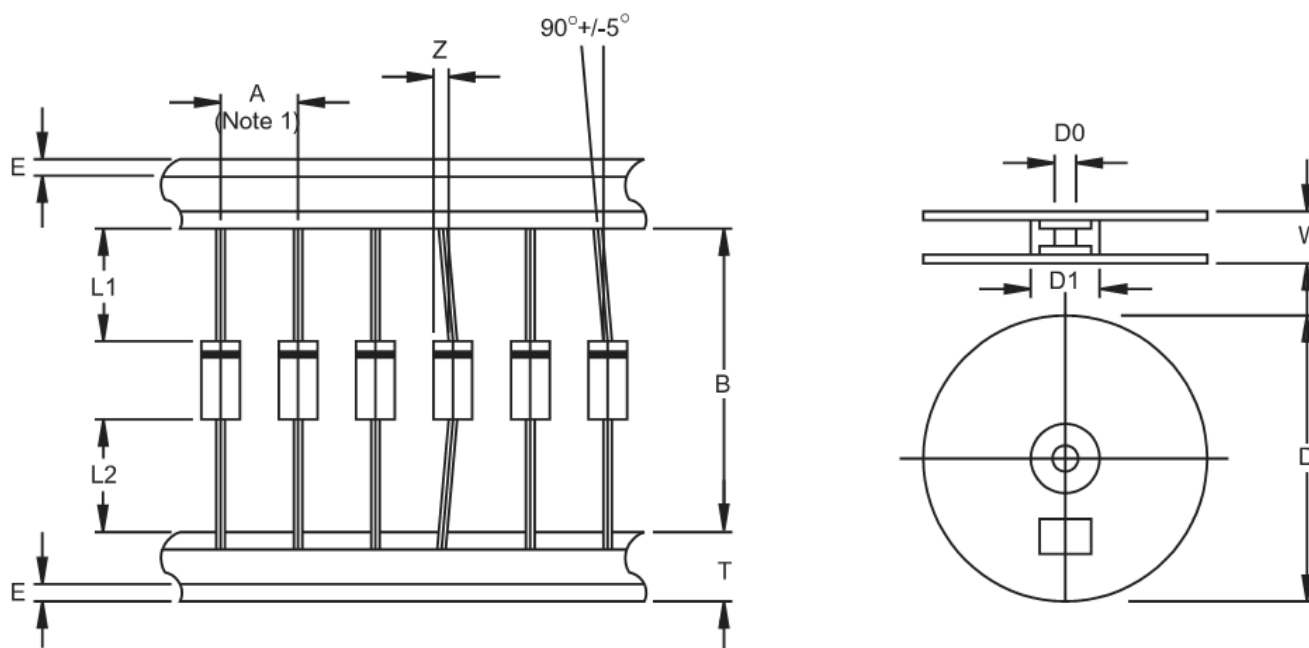

Outline	A	B	Z	T	E	L1-L2	D	D1	D0	W
	±0.5	±1.5	MAX	±0.4	MAX	MAX		±0.3	±0.4	±1.0
DO-41	5	26	1.2	6	0.8	1	330	85.7	16.6	76
DO-41	5	52.4	1.2	6	0.8	1	330	85.7	16.6	76

Unit (mm)

Suggested Mounting Hole Rule

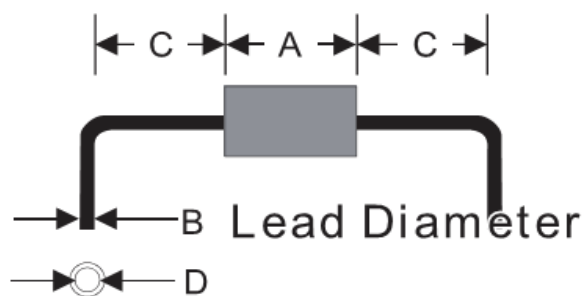

Symbol	Unit(mm)
A	5.1
B	0.8
C	3.0
D	1.2

Dimensions

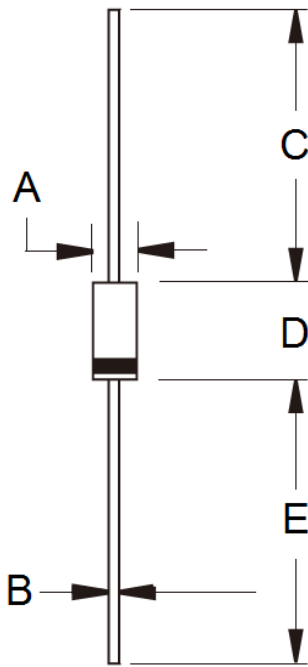

DIM.	Unit(mm)		Unit(inch)	
	Min	Max	Min	Max
A	2.00	2.70	0.079	0.106
B	0.71	0.86	0.028	0.034
C	25.40	-	1.000	-
D	4.20	5.20	0.165	0.205
E	25.40	-	1.000	-

Marking Diagram



- P/N = Specific Device Code
- G = Green Compound
- YWW = Date Code
- F = Factory Code