

PHOTOREFLECTIVE SENSOR LEADFRAME PACKAGE

HVS6003-002

FEATURES:

- VCSEL and phototransistor in industry standard leadframe packaging
- IEC 80625 Class I Laser Product
- Optical plastics block visible wavelength for better ambient light rejection
- Optical isolation of VCSEL and Phototransistor
- Narrow beam VCSEL allows sensing distances of more than 20mm
- Very low power consumption

The HVS6003-002 is designed as a higher performance alternative to LED based reflective sensors. This Vertical Cavity Surface Emitting Laser (VCSEL) based sensor enables reflective sensing at longer distances and of targets with lower specular reflection. In addition, the HVS6003-002 significantly decreases the total amount of electrical power dissipation. To further suppress ambient light, the HVS6003-002 is potted with a visible wavelength absorbing optical plastic.

IEC 80625 Class I Laser Product.



Part Number	Description
HVS6003-002	VCSEL and Phototransistor in leadframe package. Parts are shipped in industry standard tape and reel package.



ABSOLUTE MAXIMUM

Parameter	Rating
Storage Temperature	-40 to +85°C
Case Operating Temperature	-40 to +85°C
Lead Solder Temperature	260°C, 10 sec.
Laser peak forward current with pulse width less than 1µs	18mA
Laser continuous average current	15mA
Laser reverse voltage	5V
ESD Exposure (Human Body Model)	200V
Collector-Emitter Voltage	30V
Emitter-Collector Voltage	5V
Power Dissipation	100mW

*-20°C operation under assessment

¹ Heel and wrist straps must be used on a properly grounded workstation



Notice

Stresses greater than those listed under “Absolute Maximum Ratings” may cause permanent damage to the device. This is a stress rating only and functional operation of the device at these or any other conditions above those indicated in the operations section for extended periods of time may affect reliability.

Notice

The inherent design of this component causes it to be sensitive to electrostatic discharge (ESD). To prevent ESD-induced damage and/or degradation to equipment, take normal ESD precautions when handling this product

VCSEL ELECTRO-OPTICAL

 $T_A=25^\circ\text{C}$ unless otherwise stated

Phototransistor Parameters	Test Condition	Symbol	Min.	Typ.	Max.	Units	Notes
VCSEL Operating Current	Adjustable to establish operating power	I_{OP}		6	15	mA	1
Optical Power Output	$I_F=6\text{mA}$	P_O	1	1.6	2.5	mW	1
Optical Power variation with temperature	$I_F = 6\text{mA}$, $T_A = -40$ to 5°C	$\Delta P/\Delta T$		1	3	dB	2
Threshold Current		I_{TH}	1	2	2.5	mA	
Threshold Current Temperature Variation	$T_A = 0^\circ\text{C}$ to 70°C	ΔI_{TH}	-1.5		1.5	mA	3
Slope Efficiency	$P_O = 1.6\text{mW}$	η	0.25	0.4	0.5	mW/mA	4
Slope Efficiency Temperature variation	$T_A = 0^\circ\text{C}$ to 70°C	$\Delta\eta/\Delta T$		-0.6		%/ $^\circ\text{C}$	5
Peak Wavelength	$I_F=6\text{mA}$	λ_P	830	850	860	nm	
Laser Forward Voltage	$I_F=6\text{mA}$	V_F	1.5	1.8	2.2	V	
Laser Reverse Voltage	$I_R=10\mu\text{A}$	BVR_{LD}		-10		V	
Rise and Fall Times	Prebias Above Threshold, 20%-80%	t_r/t_f			500	ps	
Series Resistance	$I_F=6\text{mA}$	R_S	25	35	50	Ohms	
Series Resistance Temperature Coefficient		$\Delta R/\Delta T$		-0.3		%/ $^\circ\text{C}$	
Beam Divergence	$I_F=6\text{mA}$, $FW1/e^2$	Θ	18	24	30	DEG	6
Divergence change with Current		$\Delta\Theta/\Delta I$		0.6		DEG/mA	

NOTES:

- Operating power is set by the average current in the VCSEL.
- The VCSEL operating power can be more tightly controlled using simple circuitry discussed in the application note "VCSEL Spice Model".
- The VCSEL threshold current is parabolic with temperature. For specifications outside of the 0 to 70°C range, please contact AOC.
- Slope efficiency is defined as $\Delta P_O/\Delta I_F$ at a total power output of 1.6 mW.
- The VCSEL slope efficiency is a nearly linear function with temperature. For specifications outside of the 0 to 70°C range, please contact AOC.
- Beam divergence is defined as the $1/e^2$ power points.

TYPICAL (NOT GUARANTEED) VCSEL PERFORMANCE CHARACTERISTICS:

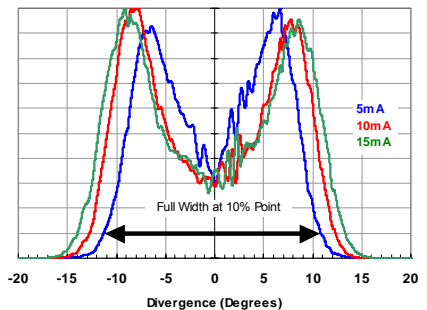
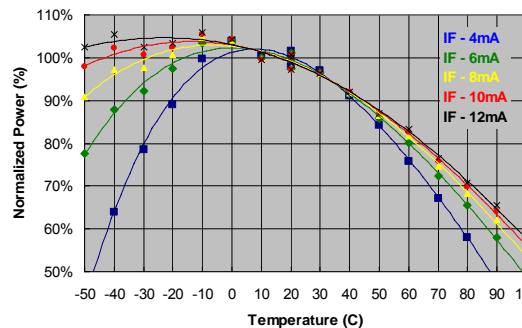
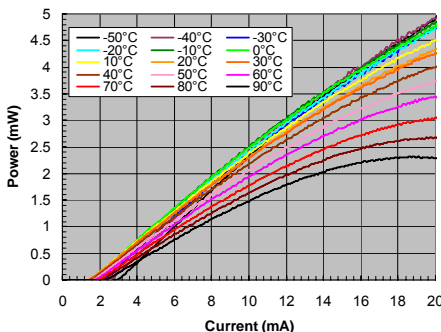

PHOTOTRANSISTOR ELECTRO-OPTICAL

$T_A=25^\circ\text{C}$ unless otherwise stated), with flex circuit.

VCSEL Parameters	Test Condition	Symbol	Min.	Typ.	Max.	Units	Notes
Optical crosstalk current	$V_{CE} = 5\text{V}$, $I_{VCSEL} = 6\text{mA}$	$I_{L, \text{Feedback}}$		0.001 5	0.01	mA	1,3
I_{CE}	$I_{VCSEL} = 6\text{mA}$, $V_{CE} = 5\text{V}$, $R_L = 100\Omega$		4	10	16	mA	2
Collector Dark Current	$V_{CE} = 5\text{V}$, $I_{VCSEL}=0$	I_{CEO}			100	nA	3
Collector – Emitter Breakdown Voltage	$I_C=100\mu\text{A}$	V_{BR-CEO}	30			V	
Emitter – Collector Breakdown Voltage	$I_E=100\mu\text{A}$	V_{BR-ECO}	5			V	
Collector – Emitter Saturation Voltage	$I_C=I_L/8$,	V_{SAT-CE}			0.4	V	
Photocurrent Rise/Fall Time	$V_{CC}=5\text{V}$, $I_L=1\text{mA}$, $R_L=1000\Omega$	T_R/T_F		10		μs	4

NOTES:

1. The crosstalk current is measured in a dark environment with no optical feedback. Ambient light can cause an offset in the measurement.
2. I_{CE} is defined with a Kodak 90% diffuse whitecard (frequency scale) placed at a distance of 1mm. Refer to the schematic representation below.
3. Collector dark current is measured with the VCSEL off and in an environment free of ambient light. Optical crosstalk is measured in the same dark environment, but with the VCSEL forward biased at 6mA
4. The rise and fall times depend on the load resistor used.

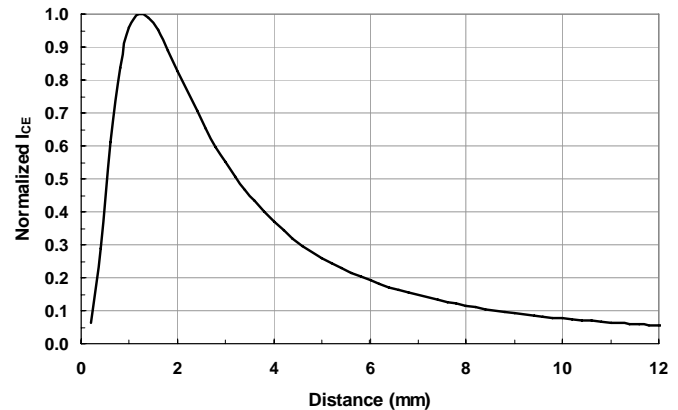
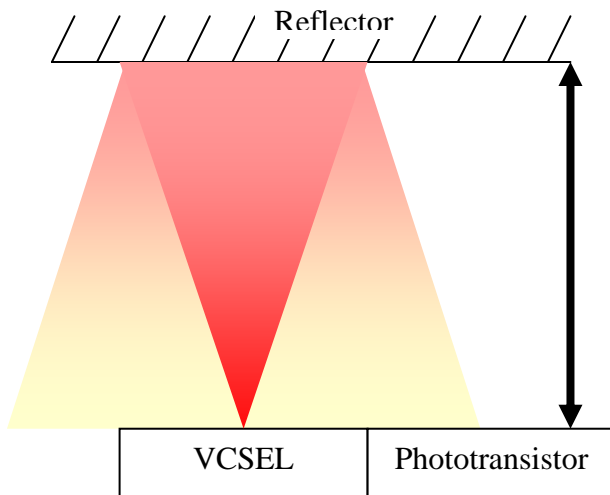

PIN OUT

PIN	Description
A	VCSEL Anode
B	VCSEL Cathode
C	PT Collector
D	PT Emitter

ELECTRICAL SCHEMATIC

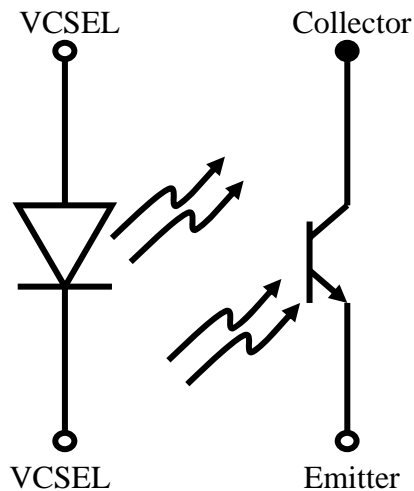

It is recommended in application that a 100-1000Ω load resistor be connected between the emitter and a negative power supply between 5 and 15V. The output can be read as the voltage across the resistor. Alternatively, the case can be connected to a power supply with the load resistor remaining connected to the emitter.

SOLDER REFLOW PROFILE

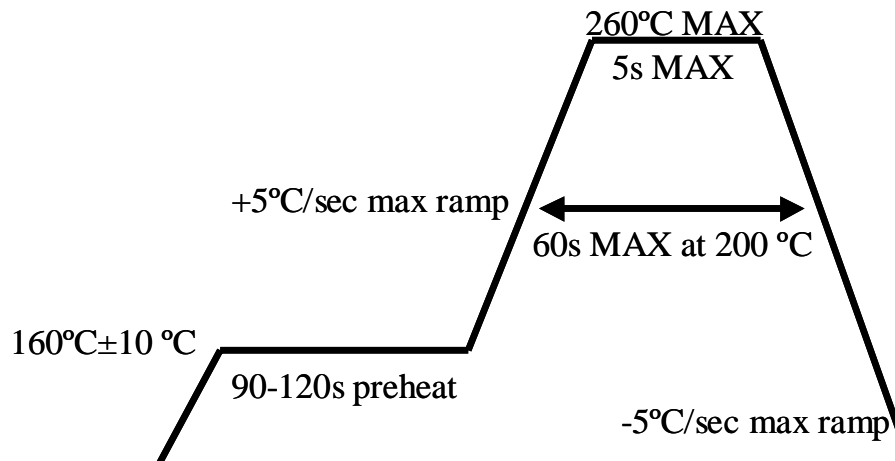

NOTES:

1. The above temperature profile shall be at the surface of LED resin.
2. Number of reflow process should be less than 2 times. If the second reflow process is performed, intervals between the first and the second process should be as short as possible to prevent moisture absorption from LED resin. Cooling process to normal temperature is required between the first and the second reflow process.
3. Temperature fluctuation to LED at pre-heat process should be minimized. (less than 6°C)

DIP SOLDER PROFILE:

1. Preheat temperature for soldering : 120 - 150 °C, for 60 - 120 seconds
2. At 200°C, soldering time is 30s - 60s
3. At 260°C, MAX soldering time is less than 5 sec
4. Number of dip soldering process must be less than 2 times and the process is to be performed in sequence. Cooling process to normal temperature will be required between the first and the second soldering process.

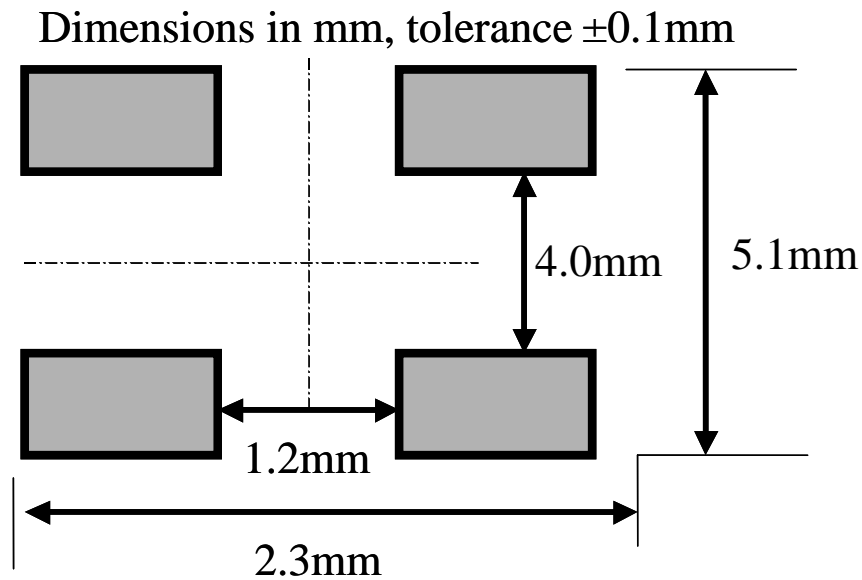
RECOMMENDED PAD LAYOUT:

MOUNTING DIMENSIONS

For reference only. All dimensions in mm [inches].

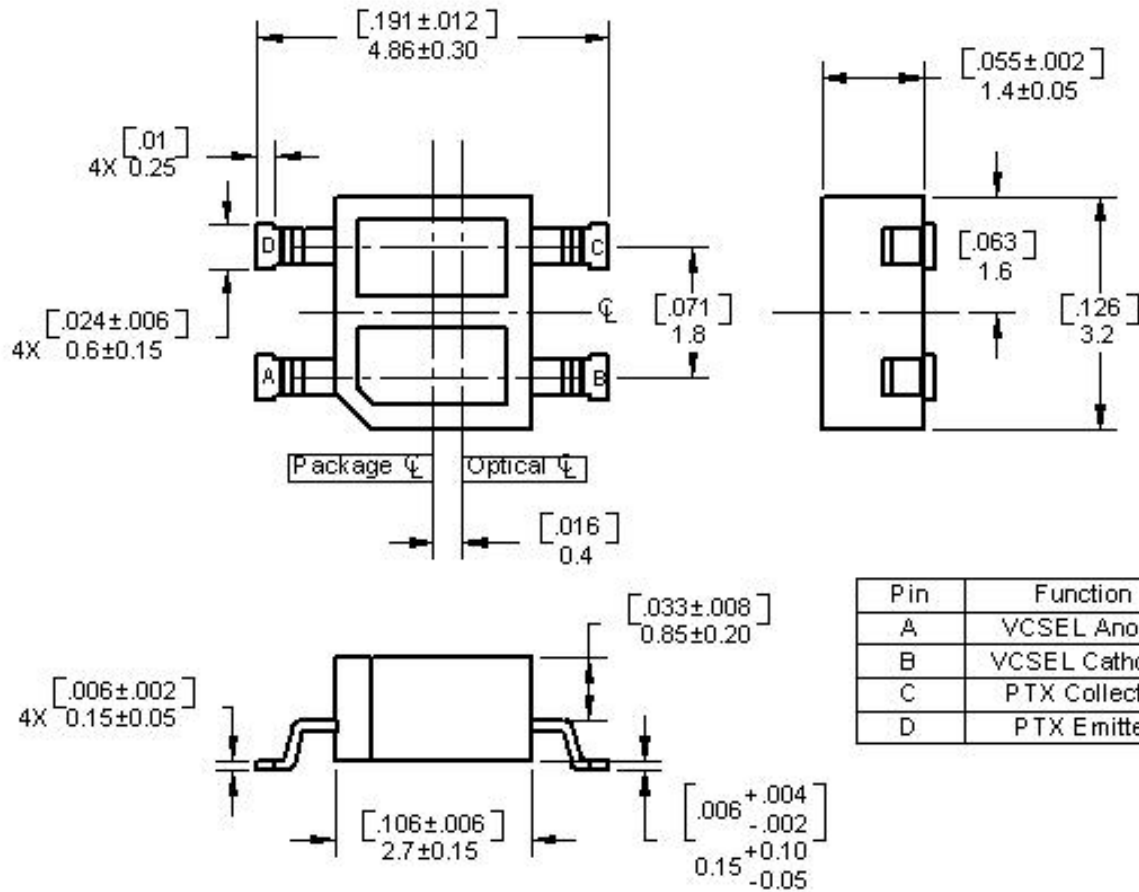
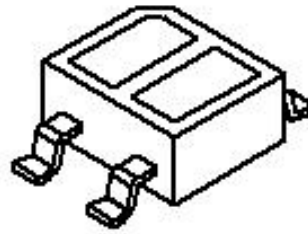

ADVANCED OPTICAL COMPONENTS

Finisar's ADVANCED OPTICAL COMPONENTS division was formed through strategic acquisition of key optical component suppliers. The company has led the industry in high volume Vertical Cavity Surface Emitting Laser (VCSEL) and associated detector technology since 1996. VCSELs have become the primary laser source for optical data communication, and are rapidly expanding into a wide variety of sensor applications. VCSELs' superior reliability, low drive current, high coupled power, narrow and circularly symmetric beam and versatile packaging options (including arrays) are enabling solutions not possible with other optical technologies. ADVANCED OPTICAL COMPONENTS is also a key supplier of Fabry-Perot (FP) and Distributed Feedback (DFB) Lasers, and Optical Isolators (OI) for use in single mode fiber data and telecommunications networks

LOCATION

- Allen, TX - Business unit headquarters, VCSEL wafer growth, wafer fabrication and TO package assembly.
- Fremont, CA – Wafer growth and fabrication of 1310 to 1550nm FP and DFB lasers.
- Shanghai, PRC – Optical passives assembly, including optical isolators and splitters.

SALES AND SERVICE

Finisar's ADVANCED OPTICAL COMPONENTS division serves its customers through a worldwide network of sales offices and distributors. For application assistance, current specifications, pricing or name of the nearest Authorized Distributor, contact a nearby sales office or call the number listed below.

AOC CAPABILITIES

ADVANCED OPTICAL COMPONENTS' advanced capabilities include:

- 1, 2, 4, 8, and 10Gbps serial VCSEL solutions
- 1, 2, 4, 8, and 10Gbps serial SW DETECTOR solutions
VCSEL and detector arrays
- 1, 2, 4, 8, and 10Gbps FP and DFB solutions at 1310 and 1550nm
- 1, 2, 4, 8, and 10Gbps serial LW DETECTOR solutions
- Optical Isolators from 1260 to 1600nm range
- Laser packaging in TO46, TO56, and Optical subassemblies with SC, LC, and MU interfaces for communication networks
- VCSELs operating at 670nm, 780nm, 980nm, and 1310nm in development
- Sensor packages include surface mount, various plastics, chip on board, chipscale packages, etc. Custom packaging options

Phone: 1-866-MY-VCSEL USA (toll free)
1-214-509-2700 USA (Direct dial)
44 (0) 174 336 5533 Europe
886-935-409898 China & Taiwan
81-90-4437-1130 Japan
82-11-220-6153 Asia Pacific &
Korea

Fax: 1-2140509-3709 USA

Email: support@adopco.com
WEB: www.finisar.com/aoc.php

Finisar
Advanced Optical Components Division