

# Micropower Voltage Reference

## ISL21010

The ISL21010 is a precision, low dropout micropower bandgap voltage reference in a space-saving SOT-23 package. It operates from a single 2.2V to 5.5V supply (minimum voltage is dependent on voltage option) and provides a  $\pm 0.2\%$  accurate reference. The ISL21010 provides up to 25mA output current sourcing with low 150mV dropout voltage.

Output voltage options include 1.024V, 1.2V, 1.5V, 2.048V, 2.5V, 3.0V, 3.3V and 4.096V. The low supply current and low dropout voltage combined with high accuracy make the ISL21010 ideal for precision battery powered applications.

## Applications

- Battery management/monitoring
- Low power standby voltages
- Portable instrumentation
- Consumer/medical electronics
- Lower cost industrial and instrumentation
- Power regulation circuits
- Control loops and compensation networks
- LED/diode supply

## Features

- Reference output voltages . . . . . 1.024V, 1.25V, 1.5V, 2.048V, 2.5V, 3.0V, 3.3V, 4.096V
- Precision 0.2% initial accuracy
- Input voltage range:
  - ISL21010-10, -12, -15 -20 . . . . . 2.2V to 5.5V
  - ISL21010-25 . . . . . 2.6V to 5.5V
  - ISL21010-30 . . . . . 3.1V to 5.5V
  - ISL21010-33 . . . . . 3.4V to 5.5V
  - ISL21010-41 . . . . . 4.2V to 5.5V
- Output current source capability . . . . . 25mA
- Operating temperature range. . . . .  $-40^{\circ}\text{C}$  to  $+125^{\circ}\text{C}$
- Output voltage noise ( $V_{\text{OUT}} = 2.048\text{V}$ ) . . . . .  $58\mu\text{V}_{\text{P-P}}$  (0.1Hz to 10Hz)
- Supply current . . . . .  $48\mu\text{A}$  (typ)
- Tempco . . . . . 50ppm/ $^{\circ}\text{C}$
- Package . . . . . 3 Ld SOT-23
- Pb-free (RoHS compliant)

## Related Literature

- [AN1819](#), "ISL21010XXEV1Z User's Guide"
- [AN1853](#), "DAQ on a Stick, Strain Gauge with Programmable Chopper Stabilized IN-Amp"
- [AN1883](#), "Low-Side Low Cost Current Sense Amplifier"

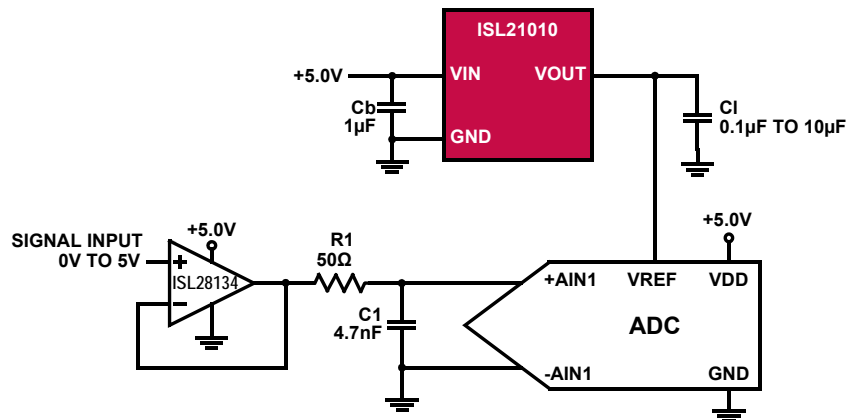

FIGURE 1. TYPICAL APPLICATION DIAGRAM

## Table of Contents

<b>Pin Configuration</b> .....	<b>3</b>
<b>Pin Descriptions</b> .....	<b>3</b>
<b>Ordering Information</b> .....	<b>3</b>
<b>Absolute Maximum Ratings</b> .....	<b>4</b>
<b>Thermal Information</b> .....	<b>4</b>
<b>Recommended Operating Conditions</b> .....	<b>4</b>
<b>Electrical Specifications (ISL21010-10, <math>V_{OUT} = 1.024V</math>)</b> .....	<b>4</b>
<b>Electrical Specifications (ISL21010-12, <math>V_{OUT} = 1.25V</math>)</b> .....	<b>5</b>
<b>Electrical Specifications (ISL21010-15, <math>V_{OUT} = 1.5V</math>)</b> .....	<b>5</b>
<b>Electrical Specifications (ISL21010-20, <math>V_{OUT} = 2.048V</math>)</b> .....	<b>6</b>
<b>Electrical Specifications (ISL21010-25, <math>V_{OUT} = 2.5V</math>)</b> .....	<b>6</b>
<b>Electrical Specifications (ISL21010-30, <math>V_{OUT} = 3.0V</math>)</b> .....	<b>7</b>
<b>Electrical Specifications (ISL21010-33, <math>V_{OUT} = 3.3V</math>)</b> .....	<b>7</b>
<b>Electrical Specifications (ISL21010-41, <math>V_{OUT} = 4.096V</math>)</b> .....	<b>8</b>
<b>Typical Performance Characteristics Curves (<math>V_{OUT} = 1.024V</math>)</b> .....	<b>9</b>
<b>Typical Performance Characteristics Curves (<math>V_{OUT} = 1.25V</math>)</b> .....	<b>12</b>
<b>Typical Performance Characteristics Curves (<math>V_{OUT} = 1.5V</math>)</b> .....	<b>15</b>
<b>Typical Performance Characteristics Curves (<math>V_{OUT} = 2.048V</math>)</b> .....	<b>18</b>
<b>Typical Performance Characteristics Curves (<math>V_{OUT} = 2.5V</math>)</b> .....	<b>21</b>
<b>Typical Performance Characteristics Curves (<math>V_{OUT} = 3.0V</math>)</b> .....	<b>24</b>
<b>Typical Performance Characteristics Curves (<math>V_{OUT} = 3.3V</math>)</b> .....	<b>27</b>
<b>Typical Performance Characteristics Curves (<math>V_{OUT} = 4.096V</math>)</b> .....	<b>30</b>
<b>Applications Information</b> .....	<b>33</b>
Micropower Operation .....	33
Board Mounting Considerations .....	33
Board Assembly Considerations .....	33
Noise Performance and Reduction .....	33
<b>Typical Application Circuit</b> .....	<b>33</b>
<b>Revision History</b> .....	<b>34</b>
<b>About Intersil</b> .....	<b>34</b>
<b>Package Outline Drawing</b> .....	<b>35</b>

# ISL21010

## Pin Configuration

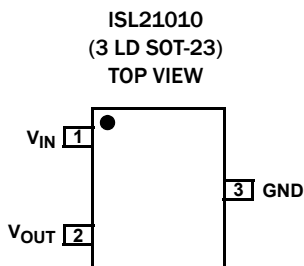

## Pin Descriptions

PIN NUMBER	PIN NAME	DESCRIPTION
1	$V_{IN}$	Input Voltage Connection
2	$V_{OUT}$	Voltage Reference Output
3	GND	Ground Connection

## Ordering Information

PART NUMBER (Notes 1, 2, 3, 4)	PART MARKING	$V_{OUT}$ OPTION (V)	INITIAL ACCURACY (%)	TEMP. RANGE (°C)	PACKAGE TAPE & REEL (RoHS Compliant)	PKG. DWG. #
ISL21010DFH310Z-TK	BEBA	1.024	±0.2	-40 to +125	3 Ld SOT-23	P3.064
ISL21010DFH310Z-T7A	BEBA	1.024	±0.2	-40 to +125	3 Ld SOT-23	P3.064
ISL21010DFH312Z-TK	BECA	1.25	±0.2	-40 to +125	3 Ld SOT-23	P3.064
ISL21010DFH312Z-T7A	BECA	1.25	±0.2	-40 to +125	3 Ld SOT-23	P3.064
ISL21010CFH315Z-TK	BDRA	1.5	±0.2	-40 to +125	3 Ld SOT-23	P3.064
ISL21010CFH315Z-T7A	BDRA	1.5	±0.2	-40 to +125	3 Ld SOT-23	P3.064
ISL21010CFH320Z-TK	BDSA	2.048	±0.2	-40 to +125	3 Ld SOT-23	P3.064
ISL21010CFH320Z-T7A	BDSA	2.048	±0.2	-40 to +125	3 Ld SOT-23	P3.064
ISL21010CFH325Z-TK	BDTA	2.5	±0.2	-40 to +125	3 Ld SOT-23	P3.064
ISL21010CFH325Z-T7A	BDTA	2.5	±0.2	-40 to +125	3 Ld SOT-23	P3.064
ISL21010CFH330Z-TK	BDVA	3.0	±0.2	-40 to +125	3 Ld SOT-23	P3.064
ISL21010CFH330Z-T7A	BDVA	3.0	±0.2	-40 to +125	3 Ld SOT-23	P3.064
ISL21010CFH333Z-TK	BDWA	3.3	±0.2	-40 to +125	3 Ld SOT-23	P3.064
ISL21010CFH333Z-T7A	BDWA	3.3	±0.2	-40 to +125	3 Ld SOT-23	P3.064
ISL21010CFH341Z-TK	BDYA	4.096	±0.2	-40 to +125	3 Ld SOT-23	P3.064
ISL21010CFH341Z-T7A	BDYA	4.096	±0.2	-40 to +125	3 Ld SOT-23	P3.064

### NOTES:

1. Please refer to [TB347](#) for details on reel specifications.
2. These Intersil Pb-free plastic packaged products employ special Pb-free material sets, molding compounds/die attach materials, and 100% matte tin plate plus anneal (e3 termination finish, which is RoHS compliant and compatible with both SnPb and Pb-free soldering operations). Intersil Pb-free products are MSL classified at Pb-free peak reflow temperatures that meet or exceed the Pb-free requirements of IPC/JEDEC J STD-020.
3. For Moisture Sensitivity Level (MSL), please see device information page for [ISL21010](#). For more information on MSL please see Tech Brief [TB363](#).
4. The part marking is located on the bottom of the part.

# ISL21010

## Absolute Maximum Ratings

Max Voltage	
$V_{IN}$ to GND	-0.5V to +6.5V
$V_{OUT}$ (pin) to GND (10s)	-0.5V to $V_{IN}$ +0.5V
Input Voltage Slew Rate (Max)	1V/ $\mu$ s
Temperature Range (Industrial)	-40 °C to +125 °C
ESD Rating	
Human Body Model	5500V
Machine Model	300V
Charged Device Model	2kV

## Thermal Information

Thermal Resistance (Typical)	$\theta_{JA}$ (°C/W)	$\theta_{JC}$ (°C/W)
3 Ld SOT-23 Package (Notes 5, 6)	275	110
Continuous Power Dissipation ( $T_A = +125^\circ\text{C}$ )	.99mW	
Storage Temperature Range	-65 °C to +150 °C	
Pb-Free Reflow Profile	see <a href="#">TB493</a>	

## Recommended Operating Conditions

Temperature	-40 °C to +125 °C
Supply Voltage	
$V_{OUT} = 1.024\text{V}, 1.25\text{V}, 1.5\text{V}, 2.048\text{V}$	2.2V to 5.5V
$V_{OUT} = 2.5\text{V}$	2.6V to 5.5V
$V_{OUT} = 3.0\text{V}$	3.1V to 5.5V
$V_{OUT} = 3.3\text{V}$	3.4V to 5.5V
$V_{OUT} = 4.096\text{V}$	4.2V to 5.5V

CAUTION: Do not operate at or near the maximum ratings listed for extended periods of time. Exposure to such conditions may adversely impact product reliability and result in failures not covered by warranty.

### NOTES:

- $\theta_{JA}$  is measured with the component mounted on a high effective thermal conductivity test board in free air. See Tech Brief [TB379](#) for details.
- For  $\theta_{JC}$ , the "case temp" location is taken at the package top center.
- Post-reflow drift for the ISL21010 devices may shift up to 4.0mV based on simulated reflow at 260 °C peak temperature, three passes. The system design engineer must take this into account when considering the reference voltage after assembly.

**Electrical Specifications (ISL21010-10,  $V_{OUT} = 1.024\text{V}$ )**  $V_{IN} = 3.0\text{V}$ ,  $T_A = +25^\circ\text{C}$ ,  $I_{OUT} = 0\text{A}$ , unless otherwise specified. **Boldface limits apply across the operating temperature range, -40 °C to +125 °C.**

PARAMETER	DESCRIPTION	TEST CONDITIONS	MIN (Note 8)	TYP	MAX (Note 8)	UNIT
$V_{OUT}$	Output Voltage			1.024		V
$V_{OA}$	$V_{OUT}$ Accuracy at $T_A = +25^\circ\text{C}$ (Note 7)		-0.2		+0.2	%
TC $V_{OUT}$	Output Voltage Temperature Coefficient (Note 9)			15	<b>50</b>	ppm/°C
$V_{IN}$	Input Voltage Range		<b>2.2</b>		<b>5.5</b>	V
$I_{IN}$	Supply Current	$T_A = +25^\circ\text{C}$		46	80	$\mu\text{A}$
		$T_A = -40^\circ\text{C}$ to $+125^\circ\text{C}$		60	<b>100</b>	$\mu\text{A}$
$\Delta V_{OUT}/\Delta V_{IN}$	Line Regulation	$2.2\text{V} \leq V_{IN} \leq 5.5\text{V}$		5	<b>100</b>	$\mu\text{V}/\text{V}$
$\Delta V_{OUT}/\Delta I_{OUT}$	Load Regulation	Sourcing: $0\text{mA} \leq I_{OUT} \leq 25\text{mA}$		15	<b>110</b>	$\mu\text{V}/\text{mA}$
		Sinking: $-1\text{mA} \leq I_{OUT} \leq 0\text{mA}$		17		$\mu\text{V}/\text{mA}$
$I_{SC}$	Short Circuit Current	$T_A = +25^\circ\text{C}$ , $V_{OUT}$ tied to GND		<b>118</b>		mA
$t_R$	Turn-on Settling Time	$V_{OUT} = \pm 0.1\%$ , $C_{OUT} = 1\mu\text{F}$		300		$\mu\text{s}$
	Ripple Rejection	$f = 120\text{Hz}$		70		dB
$e_N$	Output Voltage Noise	$0.1\text{Hz} \leq f \leq 10\text{Hz}$		24		$\mu\text{V}_{P-P}$
$V_N$	Broadband Voltage Noise	$10\text{Hz} \leq f \leq 1\text{kHz}$		14		$\mu\text{V}_{RMS}$
$\Delta V_{OUT}/\Delta T_A$	Thermal Hysteresis (Note 11)	$\Delta T_A = +165^\circ\text{C}$		100		ppm
$\Delta V_{OUT}/\Delta t$	Long Term Stability	1000 hours, $T_A = +25^\circ\text{C}$		110		ppm

# ISL21010

**Electrical Specifications (ISL21010-12,  $V_{OUT} = 1.25V$ )**  $V_{IN} = 3.0V$ ,  $T_A = +25^\circ C$ ,  $I_{OUT} = 0A$ , unless otherwise specified.  
**Boldface limits apply across the operating temperature range,  $-40^\circ C$  to  $+125^\circ C$ .**

PARAMETER	DESCRIPTION	TEST CONDITIONS	MIN (Note 8)	TYP	MAX (Note 8)	UNIT
$V_{OUT}$	Output Voltage			1.25		V
$V_{OA}$	$V_{OUT}$ Accuracy at $T_A = +25^\circ C$ (Note 7)		-0.2		+0.2	%
TC $V_{OUT}$	Output Voltage Temperature Coefficient (Note 9)			15	<b>50</b>	ppm/ $^\circ C$
$V_{IN}$	Input Voltage Range		<b>2.2</b>		<b>5.5</b>	V
$I_{IN}$	Supply Current	$T_A = +25^\circ C$		46	80	$\mu A$
		$T_A = -40^\circ C$ to $+125^\circ C$			<b>100</b>	$\mu A$
$\Delta V_{OUT}/\Delta V_{IN}$	Line Regulation	$2.2V \leq V_{IN} \leq 5.5V$		1	<b>100</b>	$\mu V/V$
$\Delta V_{OUT}/\Delta I_{OUT}$	Load Regulation	Sourcing: $0mA \leq I_{OUT} \leq 25mA$		35	<b>110</b>	$\mu V/mA$
		Sinking: $-1mA \leq I_{OUT} \leq 0mA$		50		$\mu V/mA$
$I_{SC}$	Short Circuit Current	$T_A = +25^\circ C$ , $V_{OUT}$ tied to GND		118		mA
$t_R$	Turn-on Settling Time	$V_{OUT} = \pm 0.1\%$ , $C_{OUT} = 1\mu F$		300		$\mu s$
	Ripple Rejection	$f = 120Hz$		68		dB
$e_N$	Output Voltage Noise	$0.1Hz \leq f \leq 10Hz$		27		$\mu V_{P-P}$
$V_N$	Broadband Voltage Noise	$10Hz \leq f \leq 1kHz$		17		$\mu V_{RMS}$
$\Delta V_{OUT}/\Delta T_A$	Thermal Hysteresis (Note 11)	$\Delta T_A = +165^\circ C$		100		ppm
$\Delta V_{OUT}/\Delta t$	Long Term Stability	1000 hours, $T_A = +25^\circ C$		110		ppm

**Electrical Specifications (ISL21010-15,  $V_{OUT} = 1.5V$ )**  $V_{IN} = 3.0V$ ,  $T_A = +25^\circ C$ ,  $I_{OUT} = 0A$ , unless otherwise specified.  
**Boldface limits apply across the operating temperature range,  $-40^\circ C$  to  $+125^\circ C$ .**

PARAMETER	DESCRIPTION	TEST CONDITIONS	MIN (Note 8)	TYP	MAX (Note 8)	UNIT
$V_{OUT}$	Output Voltage			1.5		V
$V_{OA}$	$V_{OUT}$ Accuracy at $T_A = +25^\circ C$ (Note 7)		-0.2		+0.2	%
TC $V_{OUT}$	Output Voltage Temperature Coefficient (Note 9)			15	<b>50</b>	ppm/ $^\circ C$
$V_{IN}$	Input Voltage Range		<b>2.2</b>		<b>5.5</b>	V
$I_{IN}$	Supply Current	$T_A = +25^\circ C$		46	80	$\mu A$
		$T_A = -40^\circ C$ to $+125^\circ C$			<b>100</b>	$\mu A$
$\Delta V_{OUT}/\Delta V_{IN}$	Line Regulation	$2.2V \leq V_{IN} \leq 5.5V$		9	<b>100</b>	$\mu V/V$
$\Delta V_{OUT}/\Delta I_{OUT}$	Load Regulation	Sourcing: $0mA \leq I_{OUT} \leq 25mA$		37	<b>110</b>	$\mu V/mA$
		Sinking: $-1mA \leq I_{OUT} \leq 0mA$		50		$\mu V/mA$
$I_{SC}$	Short Circuit Current	$T_A = +25^\circ C$ , $V_{OUT}$ tied to GND		118		mA
$t_R$	Turn-on Settling Time	$V_{OUT} = \pm 0.1\%$ , $C_{OUT} = 1\mu F$		300		$\mu s$
	Ripple Rejection	$f = 120Hz$		66		dB
$e_N$	Output Voltage Noise	$0.1Hz \leq f \leq 10Hz$		35		$\mu V_{P-P}$
$V_N$	Broadband Voltage Noise	$10Hz \leq f \leq 1kHz$		20		$\mu V_{RMS}$
$\Delta V_{OUT}/\Delta T_A$	Thermal Hysteresis (Note 11)	$\Delta T_A = +165^\circ C$		100		ppm
$\Delta V_{OUT}/\Delta t$	Long Term Stability	1000 hours, $T_A = +25^\circ C$		110		ppm

# ISL21010

**Electrical Specifications (ISL21010-20,  $V_{OUT} = 2.048V$ )**  $V_{IN} = 3.0V$ ,  $T_A = +25^\circ C$ ,  $I_{OUT} = 0A$ , unless otherwise specified. **Boldface limits apply across the operating temperature range,  $-40^\circ C$  to  $+125^\circ C$ .**

PARAMETER	DESCRIPTION	TEST CONDITIONS	MIN (Note 8)	TYP	MAX (Note 8)	UNIT
$V_{OUT}$	Output Voltage			2.048		V
$V_{OA}$	$V_{OUT}$ Accuracy at $T_A = +25^\circ C$ (Note 7)		-0.2		+0.2	%
TC $V_{OUT}$	Output Voltage Temperature Coefficient (Note 9)			15	<b>50</b>	ppm/ $^\circ C$
$V_{IN}$	Input Voltage Range		<b>2.2</b>		<b>5.5</b>	V
$I_{IN}$	Supply Current	$T_A = +25^\circ C$		46	80	$\mu A$
		$T_A = -40^\circ C$ to $+125^\circ C$			<b>100</b>	$\mu A$
$\Delta V_{OUT}/\Delta V_{IN}$	Line Regulation	$2.2V \leq V_{IN} \leq 5.5V$		37	<b>130</b>	$\mu V/V$
$\Delta V_{OUT}/\Delta I_{OUT}$	Load Regulation	Sourcing: $0mA \leq I_{OUT} \leq 25mA$		18	<b>110</b>	$\mu V/mA$
		Sinking: $-1mA \leq I_{OUT} \leq 0mA$		10		$\mu V/mA$
$I_{SC}$	Short Circuit Current	$T_A = +25^\circ C$ , $V_{OUT}$ tied to GND		118		mA
$t_R$	Turn-on Settling Time	$V_{OUT} = \pm 0.1\%$ , $C_{OUT} = 1\mu F$		300		$\mu s$
	Ripple Rejection	$f = 120Hz$		66		dB
$e_N$	Output Voltage Noise	$0.1Hz \leq f \leq 10Hz$		58		$\mu V_{P-P}$
$V_N$	Broadband Voltage Noise	$10Hz \leq f \leq 1kHz$		26		$\mu V_{RMS}$
$\Delta V_{OUT}/\Delta T_A$	Thermal Hysteresis (Note 11)	$\Delta T_A = +165^\circ C$		100		ppm
$\Delta V_{OUT}/\Delta t$	Long Term Stability	1000 hours, $T_A = +25^\circ C$		50		ppm

**Electrical Specifications (ISL21010-25,  $V_{OUT} = 2.5V$ )**  $V_{IN} = 3.0V$ ,  $T_A = +25^\circ C$ ,  $I_{OUT} = 0A$ , unless otherwise specified. **Boldface limits apply across the operating temperature range,  $-40^\circ C$  to  $+125^\circ C$ .**

PARAMETER	DESCRIPTION	TEST CONDITIONS	MIN (Note 8)	TYP	MAX (Note 8)	UNIT
$V_{OUT}$	Output Voltage			2.5		V
$V_{OA}$	$V_{OUT}$ Accuracy at $T_A = +25^\circ C$ (Note 7)		-0.2		+0.2	%
TC $V_{OUT}$	Output Voltage Temperature Coefficient (Note 9)			15	<b>50</b>	ppm/ $^\circ C$
$V_{IN}$	Input Voltage Range		<b>2.6</b>		<b>5.5</b>	V
$I_{IN}$	Supply Current	$T_A = +25^\circ C$		46	80	$\mu A$
		$T_A = -40^\circ C$ to $+125^\circ C$			<b>100</b>	$\mu A$
$\Delta V_{OUT}/\Delta V_{IN}$	Line Regulation	$2.6V \leq V_{IN} \leq 5.5V$		62	<b>245</b>	$\mu V/V$
$\Delta V_{OUT}/\Delta I_{OUT}$	Load Regulation	Sourcing: $0mA \leq I_{OUT} \leq 25mA$		29	<b>110</b>	$\mu V/mA$
		Sinking: $-1mA \leq I_{OUT} \leq 0mA$		50		$\mu V/mA$
$V_{INDO}$	Dropout Voltage (Note 10)	$I_{OUT} = 10mA$		60	<b>150</b>	mV
$I_{SC}$	Short Circuit Current	$T_A = +25^\circ C$ , $V_{OUT}$ tied to GND		118		mA
$t_R$	Turn-on Settling Time	$V_{OUT} = \pm 0.1\%$ , $C_{OUT} = 1\mu F$		300		$\mu s$
	Ripple Rejection	$f = 120Hz$		62		dB
$e_N$	Output Voltage Noise	$0.1Hz \leq f \leq 10Hz$		67		$\mu V_{P-P}$
$V_N$	Broadband Voltage Noise	$10Hz \leq f \leq 1kHz$		37		$\mu V_{RMS}$
$\Delta V_{OUT}/\Delta T_A$	Thermal Hysteresis (Note 11)	$\Delta T_A = +165^\circ C$		100		ppm
$\Delta V_{OUT}/\Delta t$	Long Term Stability	1000 hours, $T_A = +25^\circ C$		110		ppm

# ISL21010

**Electrical Specifications (ISL21010-30,  $V_{OUT} = 3.0V$ )**  $V_{IN} = 5.0V$ ,  $T_A = +25^\circ C$ ,  $I_{OUT} = 0A$ , unless otherwise specified.  
**Boldface limits apply across the operating temperature range,  $-40^\circ C$  to  $+125^\circ C$ .**

PARAMETER	DESCRIPTION	TEST CONDITIONS	MIN (Note 8)	TYP	MAX (Note 8)	UNIT
$V_{OUT}$	Output Voltage			3.0		V
$V_{OA}$	$V_{OUT}$ Accuracy at $T_A = +25^\circ C$ (Note 7)		-0.2		+0.2	%
TC $V_{OUT}$	Output Voltage Temperature Coefficient (Note 9)			15	<b>50</b>	ppm/ $^\circ C$
$V_{IN}$	Input Voltage Range		<b>3.1</b>		<b>5.5</b>	V
$I_{IN}$	Supply Current	$T_A = +25^\circ C$		48	80	$\mu A$
		$T_A = -40^\circ C$ to $+125^\circ C$			<b>100</b>	$\mu A$
$\Delta V_{OUT}/\Delta V_{IN}$	Line Regulation	$3.1V \leq V_{IN} \leq 5.5V$		73	<b>230</b>	$\mu V/V$
$\Delta V_{OUT}/\Delta I_{OUT}$	Load Regulation	Sourcing: $0mA \leq I_{OUT} \leq 25mA$		48	<b>110</b>	$\mu V/mA$
		Sinking: $-1mA \leq I_{OUT} \leq 0mA$		10		$\mu V/mA$
$V_{INDO}$	Dropout Voltage (Note 10)	$I_{OUT} = 10mA$		60	<b>150</b>	mV
$I_{SC}$	Short Circuit Current	$T_A = +25^\circ C$ , $V_{OUT}$ tied to GND		126		mA
$t_R$	Turn-on Settling Time	$V_{OUT} = \pm 0.1\%$ , $C_{OUT} = 1\mu F$		300		$\mu s$
	Ripple Rejection	$f = 120Hz$		62		dB
$e_N$	Output Voltage Noise	$0.1Hz \leq f \leq 10Hz$		86		$\mu V_{p-p}$
$V_N$	Broadband Voltage Noise	$10Hz \leq f \leq 1kHz$		36		$\mu V_{RMS}$
$\Delta V_{OUT}/\Delta T_A$	Thermal Hysteresis (Note 11)	$\Delta T_A = +165^\circ C$		100		ppm
$\Delta V_{OUT}/\Delta t$	Long Term Stability	1000 hours, $T_A = +25^\circ C$		50		ppm

**Electrical Specifications (ISL21010-33,  $V_{OUT} = 3.3V$ )**  $V_{IN} = 5.0V$ ,  $T_A = +25^\circ C$ ,  $I_{OUT} = 0A$ , unless otherwise specified.  
**Boldface limits apply across the operating temperature range,  $-40^\circ C$  to  $+125^\circ C$ .**

PARAMETER	DESCRIPTION	TEST CONDITIONS	MIN (Note 8)	TYP	MAX (Note 8)	UNIT
$V_{OUT}$	Output Voltage			3.3		V
$V_{OA}$	$V_{OUT}$ Accuracy at $T_A = +25^\circ C$ (Note 7)		-0.2		+0.2	%
TC $V_{OUT}$	Output Voltage Temperature Coefficient (Note 9)			15	<b>50</b>	ppm/ $^\circ C$
$V_{IN}$	Input Voltage Range		<b>3.4</b>		<b>5.5</b>	V
$I_{IN}$	Supply Current	$T_A = +25^\circ C$		48	80	$\mu A$
		$T_A = -40^\circ C$ to $+125^\circ C$			<b>100</b>	$\mu A$
$\Delta V_{OUT}/\Delta V_{IN}$	Line Regulation	$3.4V \leq V_{IN} \leq 5.5V$		80	<b>320</b>	$\mu V/V$
$\Delta V_{OUT}/\Delta I_{OUT}$	Load Regulation	Sourcing: $0mA \leq I_{OUT} \leq 25mA$		45	<b>110</b>	$\mu V/mA$
		Sinking: $-1mA \leq I_{OUT} \leq 0mA$		10		$\mu V/mA$
$V_{INDO}$	Dropout Voltage (Note 10)	$I_{OUT} = 10mA$		60	<b>150</b>	mV
$I_{SC}$	Short Circuit Current	$T_A = +25^\circ C$ , $V_{OUT}$ tied to GND		126		mA
$t_R$	Turn-on Settling Time	$V_{OUT} = \pm 0.1\%$ , $C_{OUT} = 1\mu F$		300		$\mu s$
	Ripple Rejection	$f = 120Hz$		61		dB
$e_N$	Output Voltage Noise	$0.1Hz \leq f \leq 10Hz$		95		$\mu V_{p-p}$
$V_N$	Broadband Voltage Noise	$10Hz \leq f \leq 1kHz$		40		$\mu V_{RMS}$
$\Delta V_{OUT}/\Delta T_A$	Thermal Hysteresis (Note 11)	$\Delta T_A = +165^\circ C$		100		ppm
$\Delta V_{OUT}/\Delta t$	Long Term Stability	1000 hours, $T_A = +25^\circ C$		50		ppm

# ISL21010

**Electrical Specifications (ISL21010-41,  $V_{OUT} = 4.096V$ )**  $V_{IN} = 5.0V$ ,  $T_A = +25^\circ C$ ,  $I_{OUT} = 0A$ , unless otherwise specified. **Boldface limits apply across the operating temperature range,  $-40^\circ C$  to  $+125^\circ C$ .**

PARAMETER	DESCRIPTION	TEST CONDITIONS	MIN ( <a href="#">Note 8</a> )	TYP	MAX ( <a href="#">Note 8</a> )	UNIT
$V_{OUT}$	Output Voltage			4.096		V
$V_{OA}$	$V_{OUT}$ Accuracy at $T_A = +25^\circ C$ ( <a href="#">Note 7</a> )		-0.2		+0.2	%
TC $V_{OUT}$	Output Voltage Temperature Coefficient ( <a href="#">Note 9</a> )			15	<b>50</b>	ppm/ $^\circ C$
$V_{IN}$	Input Voltage Range		<b>4.2</b>		<b>5.5</b>	V
$I_{IN}$	Supply Current	$T_A = +25^\circ C$		48	80	$\mu A$
		$T_A = -40^\circ C$ to $+125^\circ C$			<b>100</b>	$\mu A$
$\Delta V_{OUT}/\Delta V_{IN}$	Line Regulation	$4.2 V \leq V_{IN} \leq 5.5 V$		106	<b>550</b>	$\mu V/V$
$\Delta V_{OUT}/\Delta I_{OUT}$	Load Regulation	Sourcing: $0mA \leq I_{OUT} \leq 25mA$		50	<b>140</b>	$\mu V/mA$
		Sinking: $-1mA \leq I_{OUT} \leq 0mA$		50		$\mu V/mA$
$V_{INDO}$	Dropout Voltage ( <a href="#">Note 10</a> )	$I_{OUT} = 10mA$		60	<b>150</b>	mV
$I_{SC}$	Short Circuit Current	$T_A = +25^\circ C$ , $V_{OUT}$ tied to GND		126		mA
$t_R$	Turn-on Settling Time	$V_{OUT} = \pm 0.1\%$ , $C_{OUT} = 1\mu F$		300		$\mu s$
	Ripple Rejection	$f = 120Hz$		58		dB
$e_N$	Output Voltage Noise	$0.1Hz \leq f \leq 10Hz$		112		$\mu V_{p-p}$
$V_N$	Broadband Voltage Noise	$10Hz \leq f \leq 1kHz$		56		$\mu V_{RMS}$
$\Delta V_{OUT}/\Delta T_A$	Thermal Hysteresis ( <a href="#">Note 11</a> )	$\Delta T_A = +165^\circ C$		100		ppm
$\Delta V_{OUT}/\Delta t$	Long Term Stability	1000 hours, $T_A = +25^\circ C$		110		ppm

## NOTES:

- Compliance to datasheet limits is assured by one or more methods: production test, characterization and/or design.
- Over the specified temperature range. Temperature coefficient is measured by the box method whereby the change in  $V_{OUT}$  is divided by the temperature range; in this case,  $-40^\circ C$  to  $+125^\circ C = +165^\circ C$ .
- Dropout Voltage is the minimum  $V_{IN} - V_{OUT}$  differential voltage measured at the point where  $V_{OUT}$  drops 1mV from  $V_{IN} = \text{nominal}$  at  $T_A = +25^\circ C$ .
- Thermal Hysteresis is the change of  $V_{OUT}$  measured at  $T_A = +25^\circ C$  after temperature cycling over a specified range,  $\Delta T_A$ .  $V_{OUT}$  is read initially at  $T_A = +25^\circ C$  for the device under test. The device is temperature cycled and a second  $V_{OUT}$  measurement is taken at  $+25^\circ C$ . The difference between the initial  $V_{OUT}$  reading and the second  $V_{OUT}$  reading is then expressed in ppm. For  $\Delta T_A = +165^\circ C$ , the device under test is cycled from  $+25^\circ C$  to  $-40^\circ C$  to  $+125^\circ C$  to  $+25^\circ C$ .



**Typical Performance Characteristics Curves ( $V_{OUT} = 1.024V$ )**

$V_{IN} = 3.0V$ ,  $I_{OUT} = 0mA$ ,  $T_A = +25^\circ C$  unless otherwise specified.

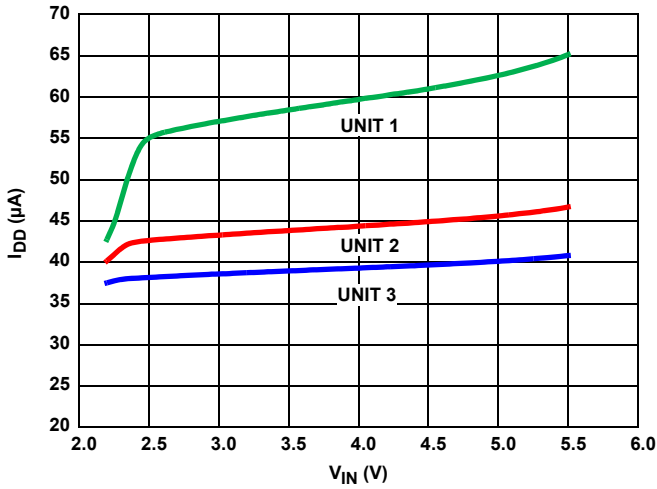

FIGURE 2.  $I_{IN}$  vs  $V_{IN}$ , THREE UNITS

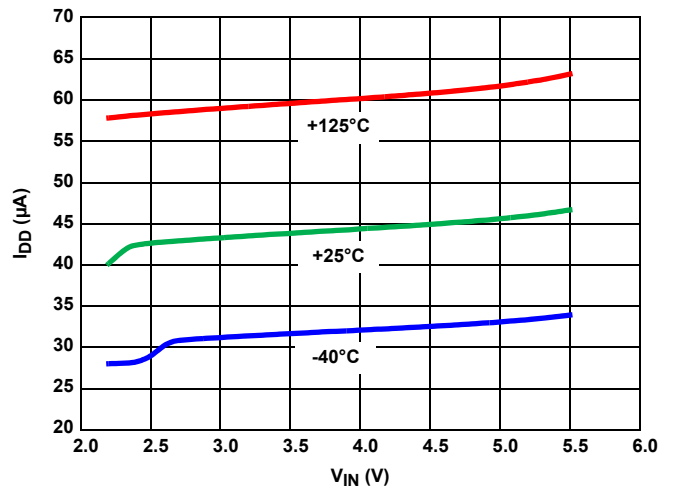

FIGURE 3.  $I_{IN}$  vs  $V_{IN}$ , OVER-TEMPERATURE

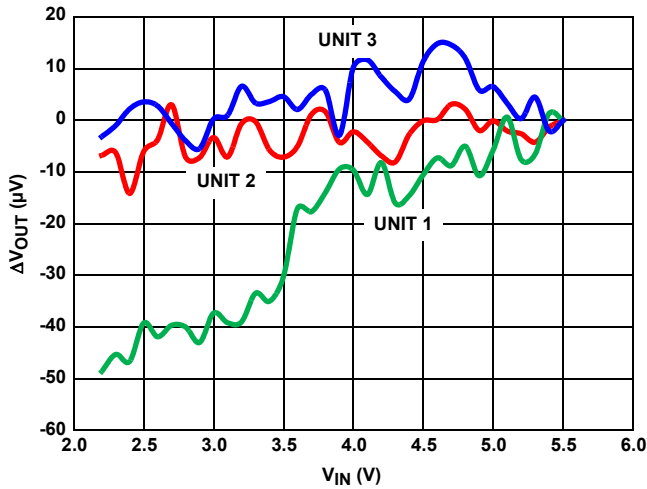

FIGURE 4. LINE REGULATION, THREE UNITS

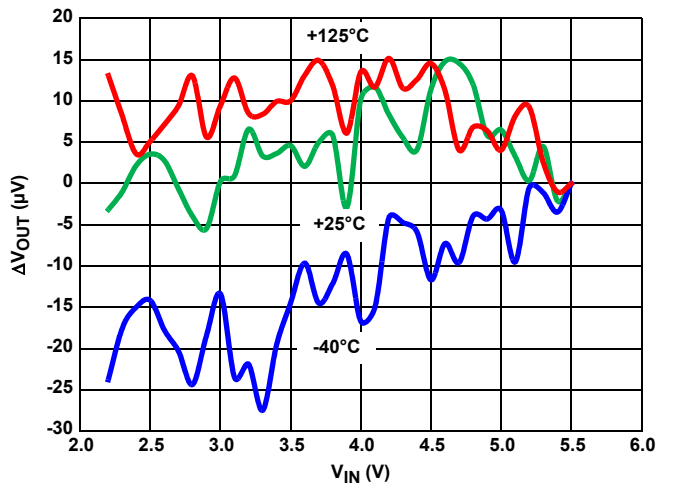

FIGURE 5. LINE REGULATION OVER-TEMPERATURE

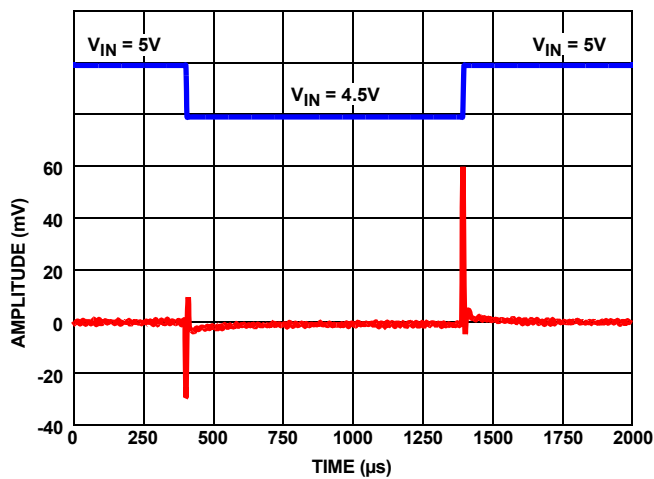

FIGURE 6. LINE TRANSIENT RESPONSE WITH  $0.22\mu F$  LOAD

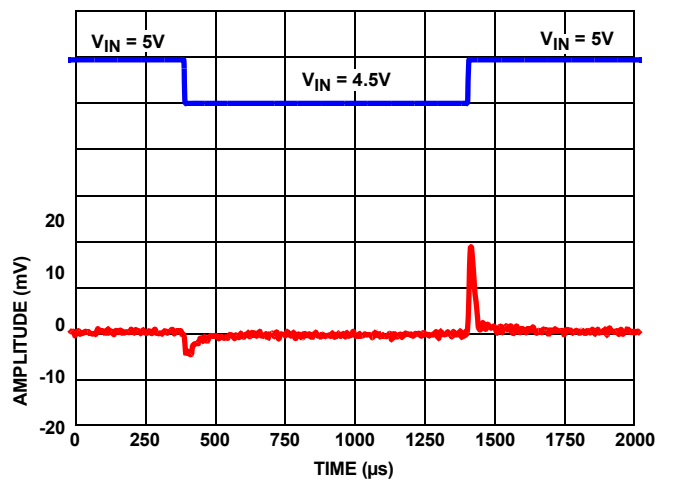

FIGURE 7. LINE TRANSIENT RESPONSE WITH  $10\mu F$  LOAD

Typical Performance Characteristics Curves ( $V_{OUT} = 1.024V$ )

$V_{IN} = 3.0V$ ,  $I_{OUT} = 0mA$ ,  $T_A = +25^\circ C$  unless otherwise specified. (Continued)

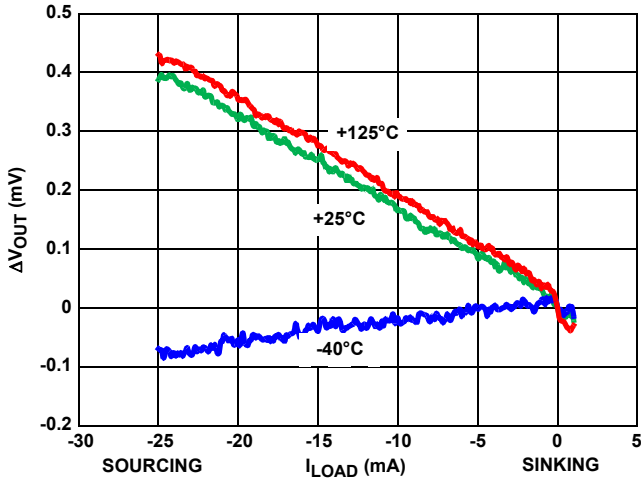

FIGURE 8. LOAD REGULATION OVER-TEMPERATURE

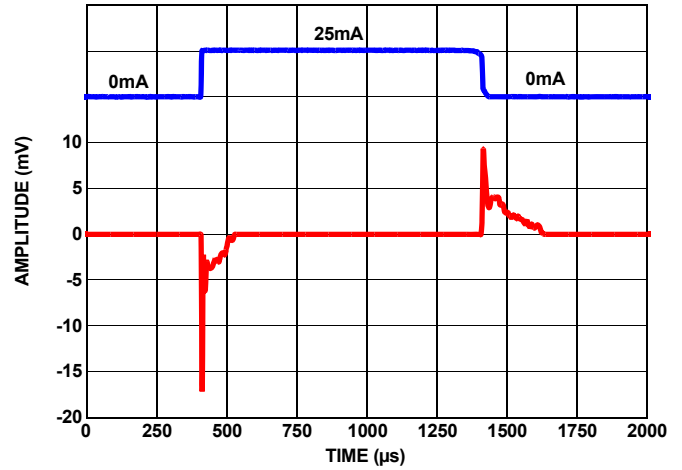

FIGURE 9. LOAD TRANSIENT RESPONSE AT 25mA LOAD AT 1µF

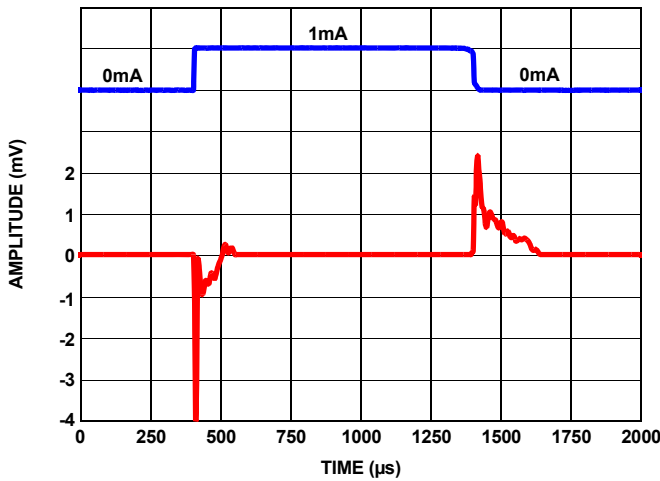

FIGURE 10. LOAD TRANSIENT RESPONSE AT 1mA LOAD AT 1µF

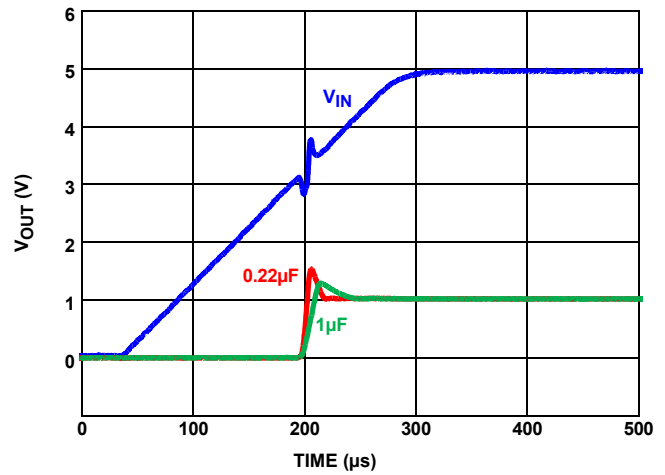

FIGURE 11. TURN-ON TIME

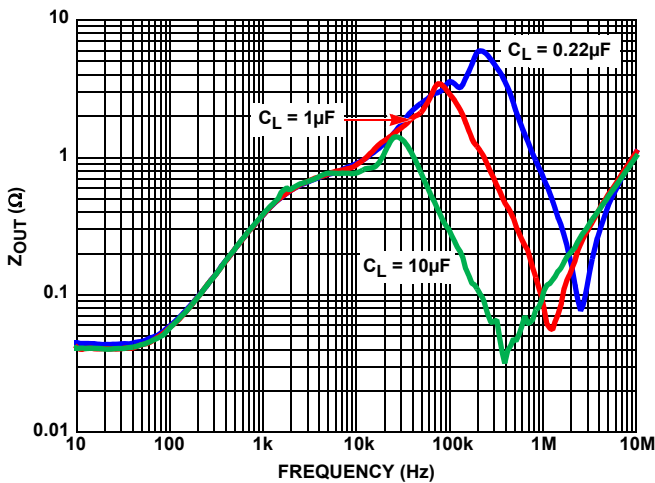

FIGURE 12.  $Z_{OUT}$  vs FREQUENCY

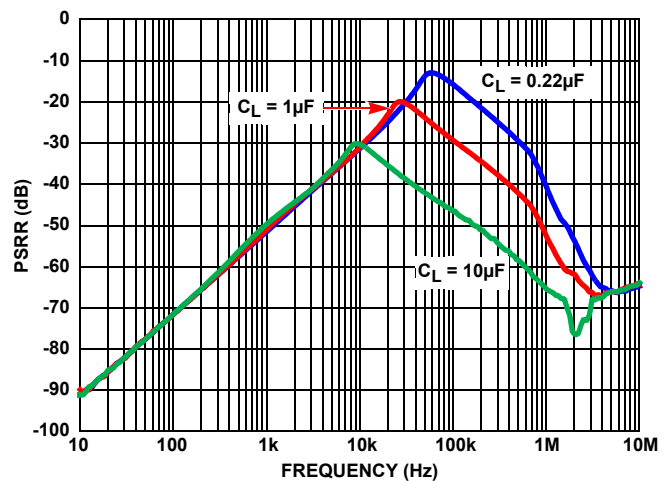

FIGURE 13. RIPPLE REJECTION AT DIFFERENT CAPACITIVE LOADS

## Typical Performance Characteristics Curves ( $V_{OUT} = 1.024V$ )

$V_{IN} = 3.0V$ ,  $I_{OUT} = 0mA$ ,  $T_A = +25^\circ C$  unless otherwise specified. (Continued)

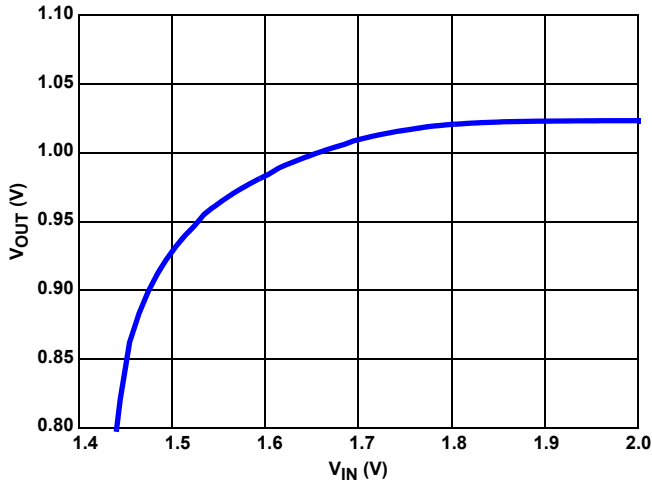

FIGURE 14. DROPOUT (10mA SOURCED LOAD)

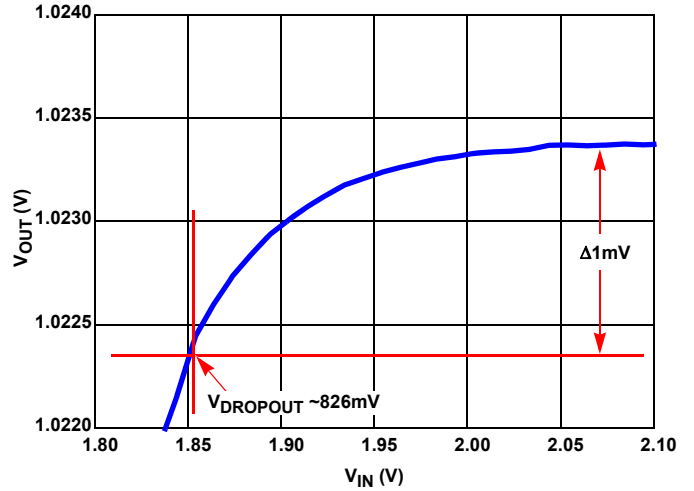

FIGURE 15. DROPOUT ZOOMED (10mA SOURCED LOAD)

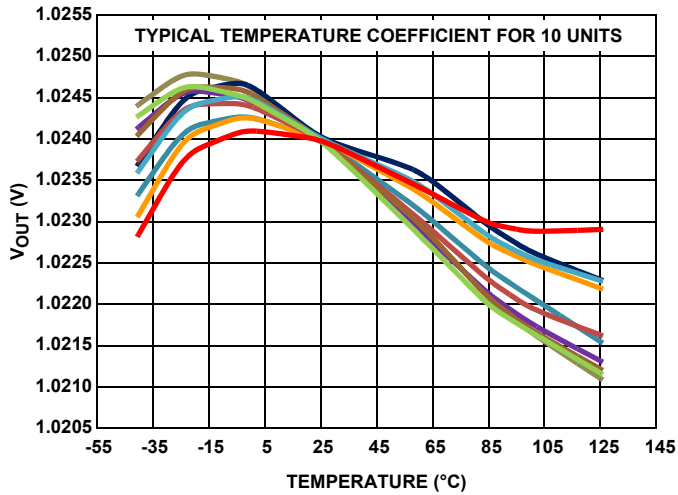

FIGURE 16.  $V_{OUT}$  vs TEMPERATURE

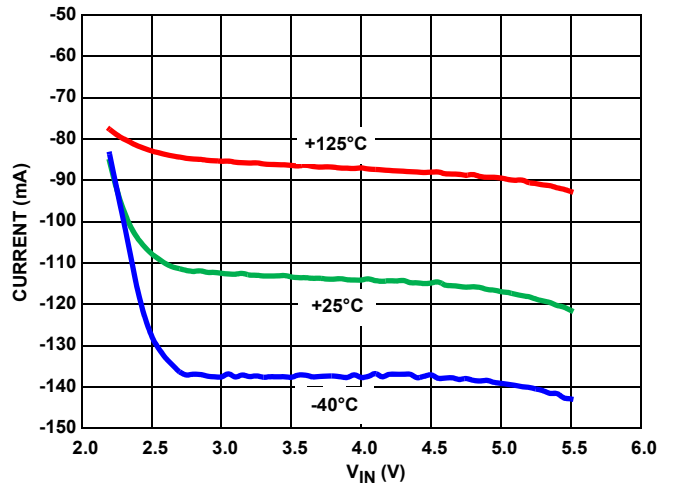

FIGURE 17. SHORT CIRCUIT TO GND

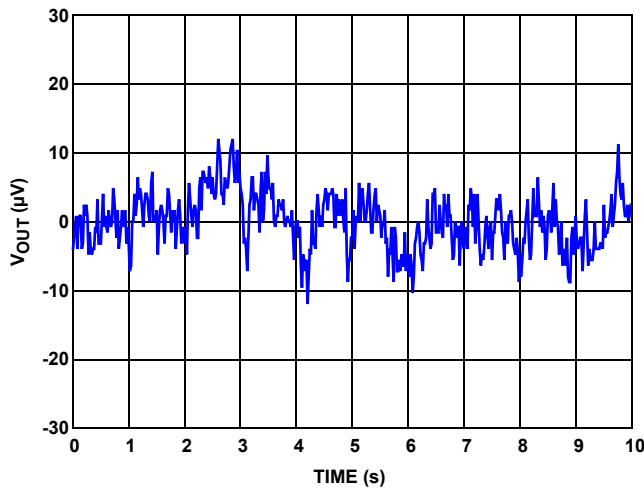

FIGURE 18.  $V_{OUT}$  vs NOISE, 0.1Hz TO 10Hz

Typical Performance Characteristics Curves ( $V_{OUT} = 1.25V$ )

$V_{IN} = 3.0V$ ,  $I_{OUT} = 0mA$ ,  $T_A = +25^\circ C$  unless otherwise specified.

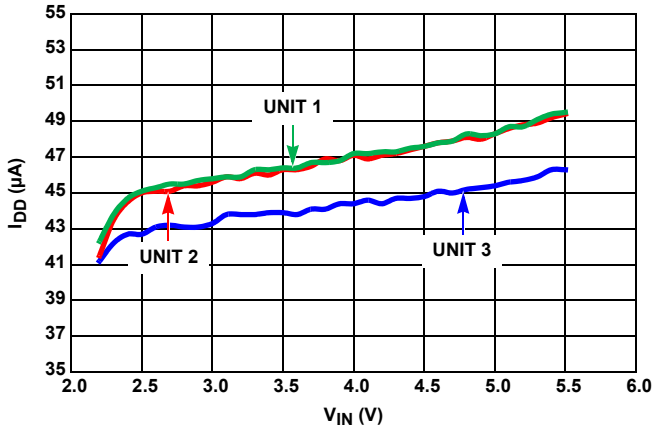

FIGURE 19.  $I_{IN}$  vs  $V_{IN}$ , THREE UNITS

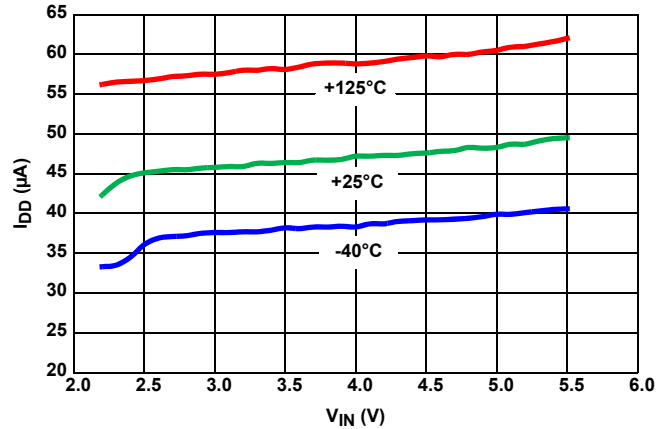

FIGURE 20.  $I_{IN}$  vs  $V_{IN}$ , OVER-TEMPERATURE

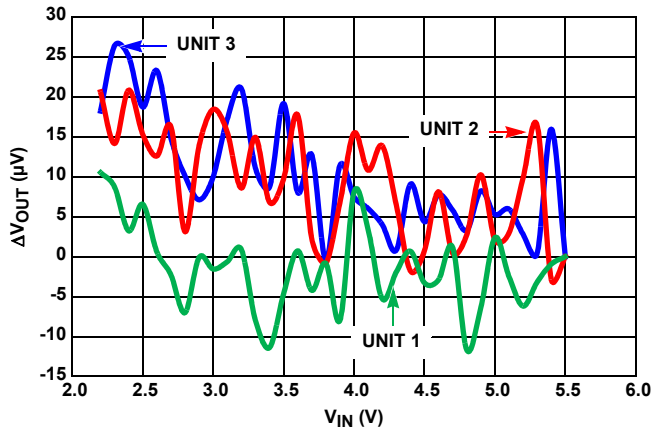

FIGURE 21. LINE REGULATION, THREE UNITS

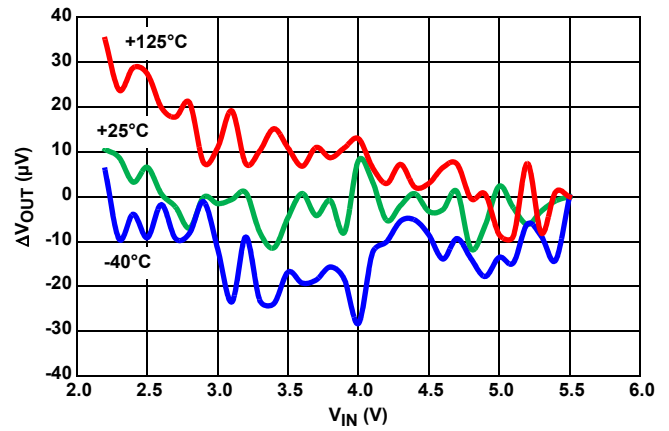

FIGURE 22. LINE REGULATION OVER-TEMPERATURE

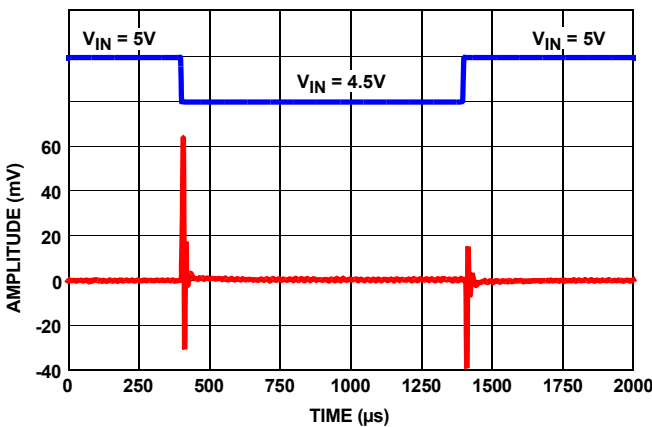

FIGURE 23. LINE TRANSIENT RESPONSE WITH  $0.1\mu F$  LOAD

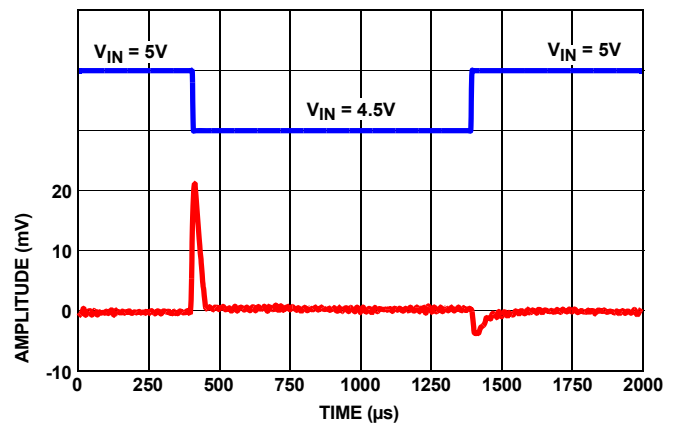

FIGURE 24. LINE TRANSIENT RESPONSE WITH  $10\mu F$  LOAD

Typical Performance Characteristics Curves ( $V_{OUT} = 1.25V$ )

$V_{IN} = 3.0V$ ,  $I_{OUT} = 0mA$ ,  $T_A = +25^\circ C$  unless otherwise specified. (Continued)

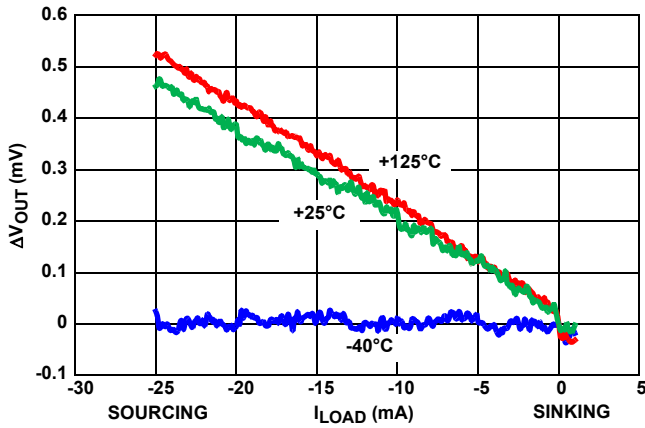

FIGURE 25. LOAD REGULATION OVER-TEMPERATURE

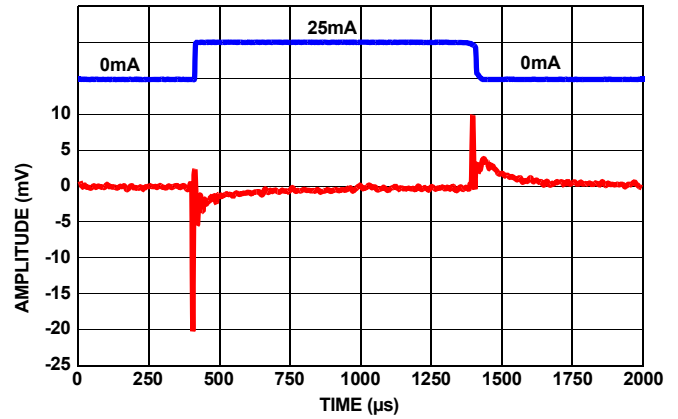

FIGURE 26. LOAD TRANSIENT RESPONSE AT 25mA LOAD AT 1µF

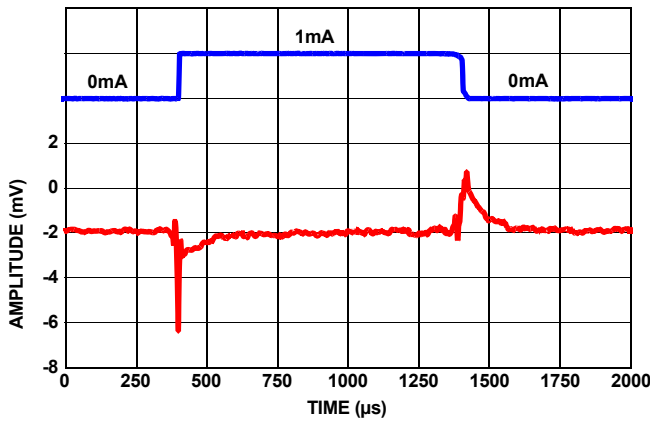

FIGURE 27. LOAD TRANSIENT RESPONSE AT 1mA LOAD AT 1µF

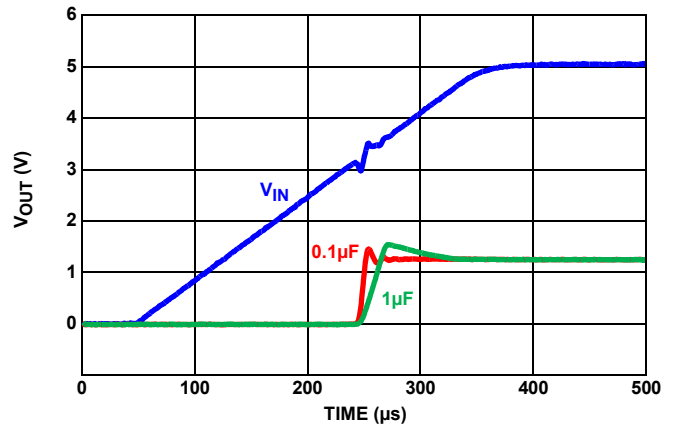

FIGURE 28. TURN-ON TIME

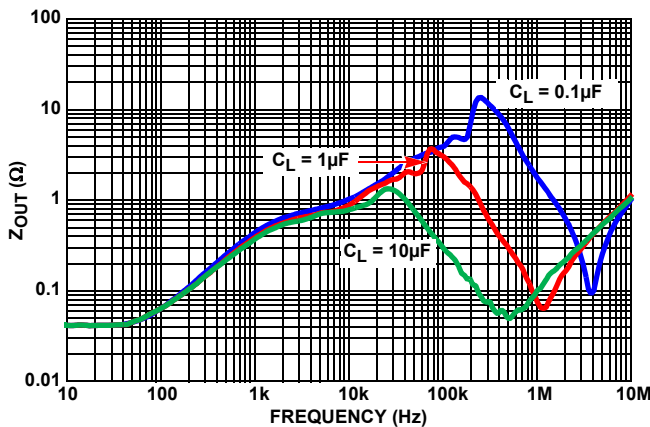

FIGURE 29.  $Z_{OUT}$  vs FREQUENCY

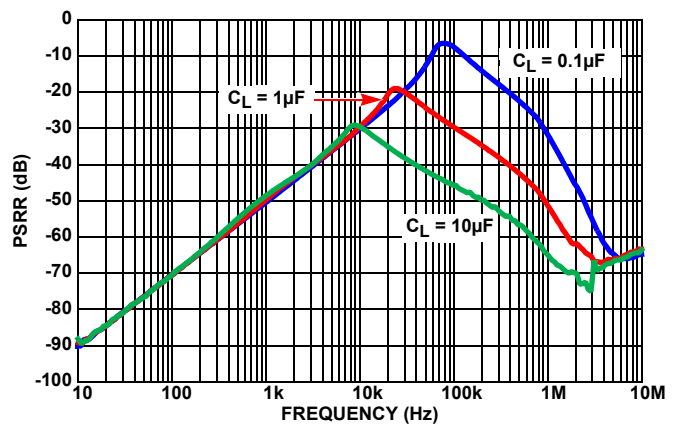

FIGURE 30. RIPPLE REJECTION AT DIFFERENT CAPACITIVE LOADS

## Typical Performance Characteristics Curves ( $V_{OUT} = 1.25V$ )

$V_{IN} = 3.0V$ ,  $I_{OUT} = 0mA$ ,  $T_A = +25^\circ C$  unless otherwise specified. (Continued)

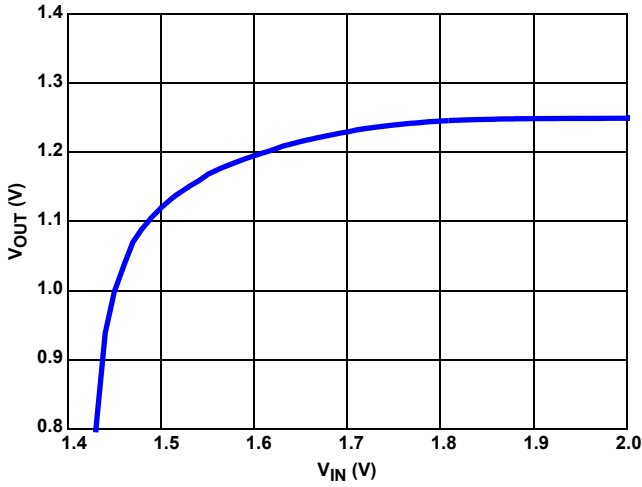

FIGURE 31. DROPOUT (10mA SOURCED LOAD)

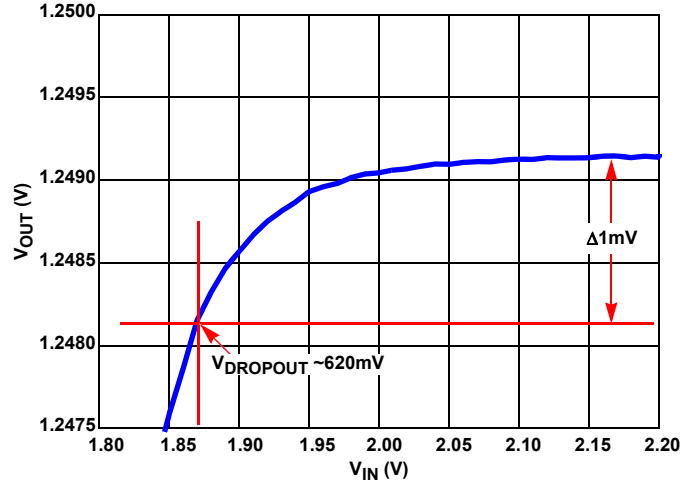

FIGURE 32. DROPOUT ZOOMED (10mA SOURCED LOAD)

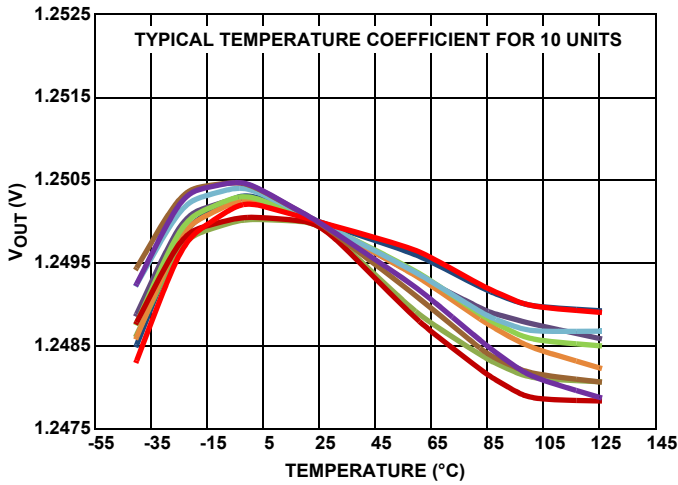

FIGURE 33.  $V_{OUT}$  vs TEMPERATURE

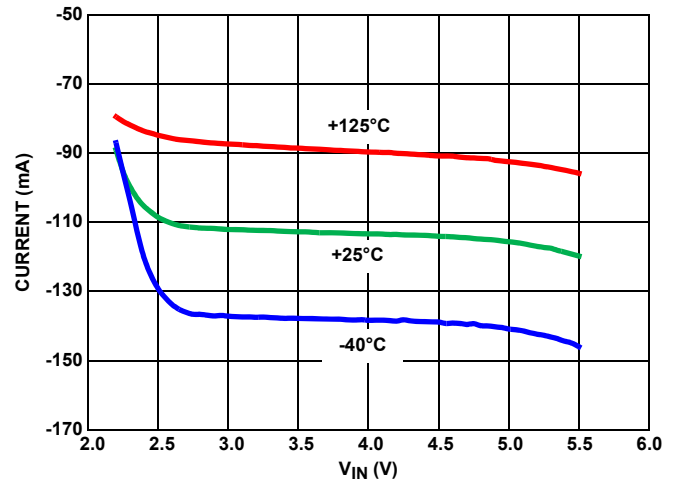

FIGURE 34. SHORT CIRCUIT TO GND

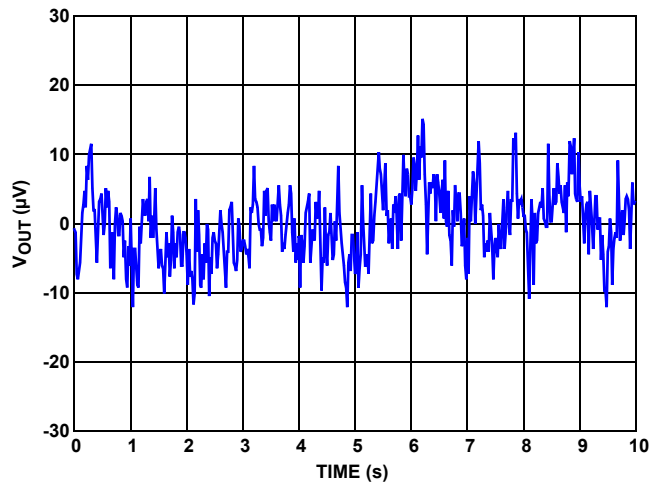

FIGURE 35.  $V_{OUT}$  vs NOISE, 0.1Hz TO 10Hz

Typical Performance Characteristics Curves ( $V_{OUT} = 1.5V$ )

$V_{IN} = 3.0V$ ,  $I_{OUT} = 0mA$ ,  $T_A = +25^\circ C$  unless otherwise specified.

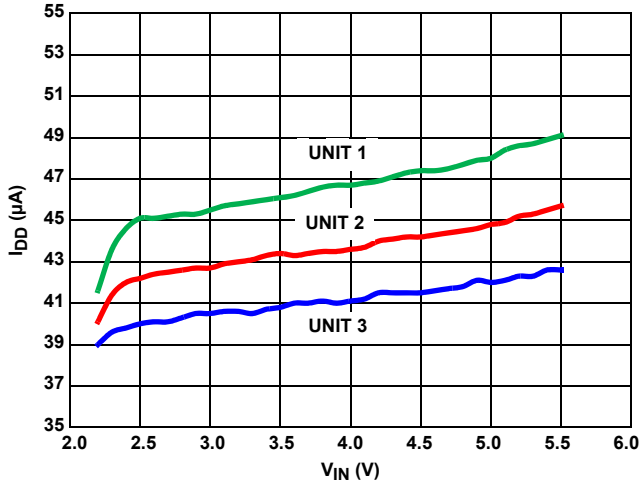

FIGURE 36.  $I_{IN}$  vs  $V_{IN}$ , THREE UNITS

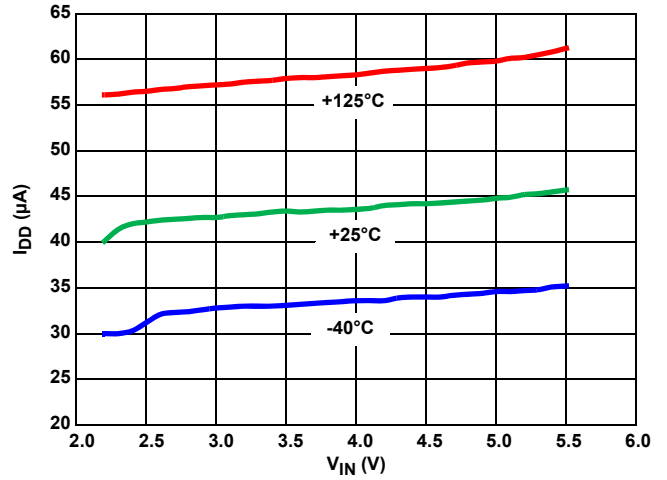

FIGURE 37.  $I_{IN}$  vs  $V_{IN}$ , OVER-TEMPERATURE

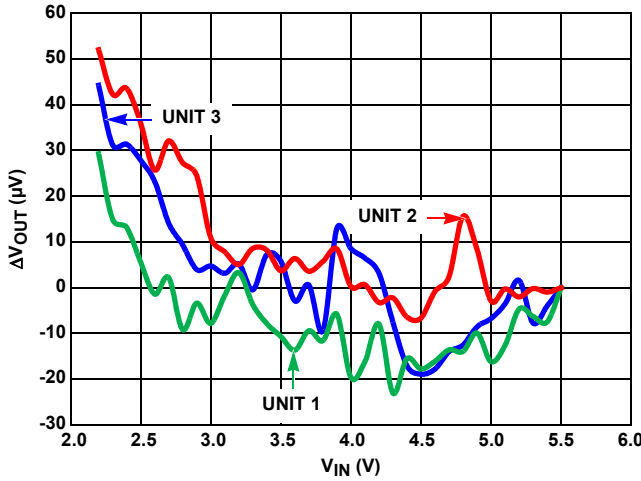

FIGURE 38. LINE REGULATION, THREE UNITS

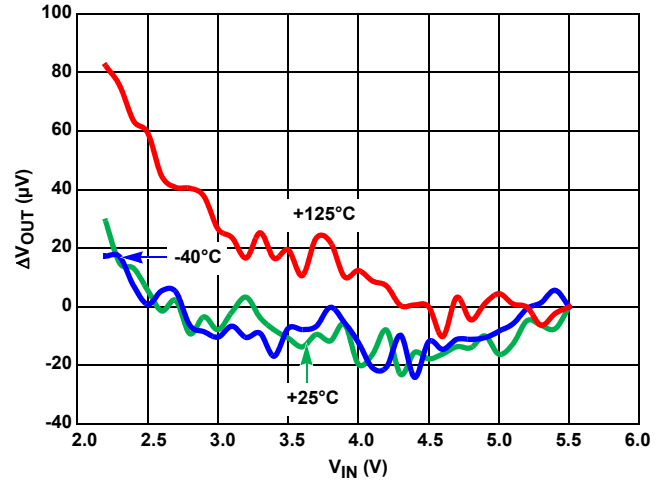

FIGURE 39. LINE REGULATION OVER-TEMPERATURE

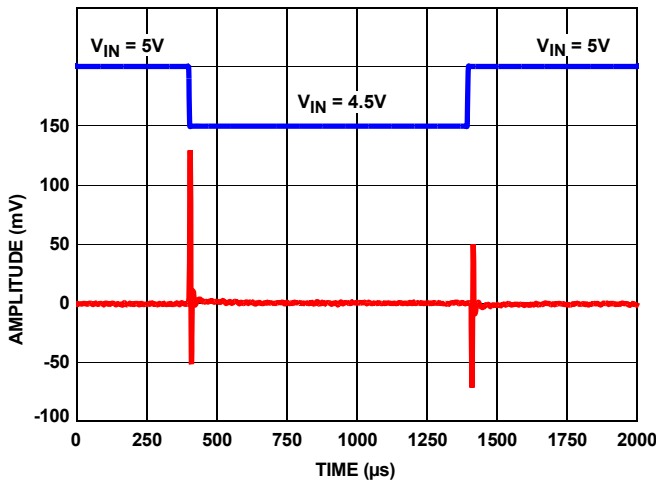

FIGURE 40. LINE TRANSIENT RESPONSE WITH  $0.1\mu F$  LOAD

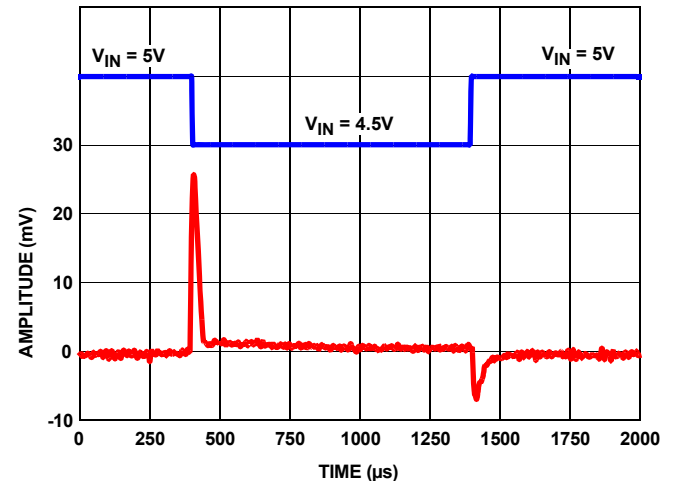

FIGURE 41. LINE TRANSIENT RESPONSE WITH  $10\mu F$  LOAD

Typical Performance Characteristics Curves ( $V_{OUT} = 1.5V$ )

$V_{IN} = 3.0V$ ,  $I_{OUT} = 0mA$ ,  $T_A = +25^\circ C$  unless otherwise specified. (Continued)

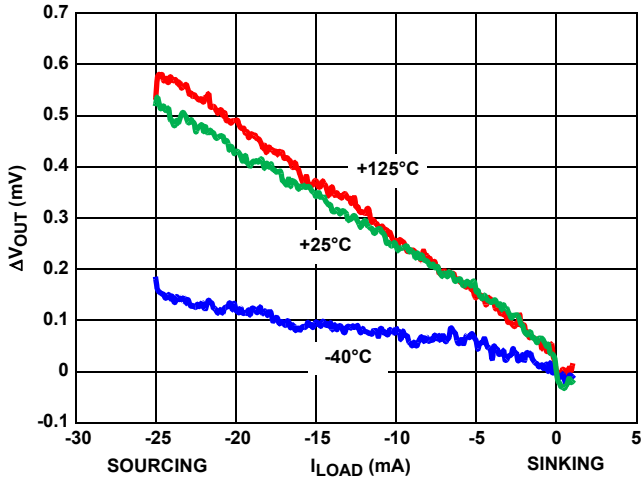

FIGURE 42. LOAD REGULATION OVER-TEMPERATURE

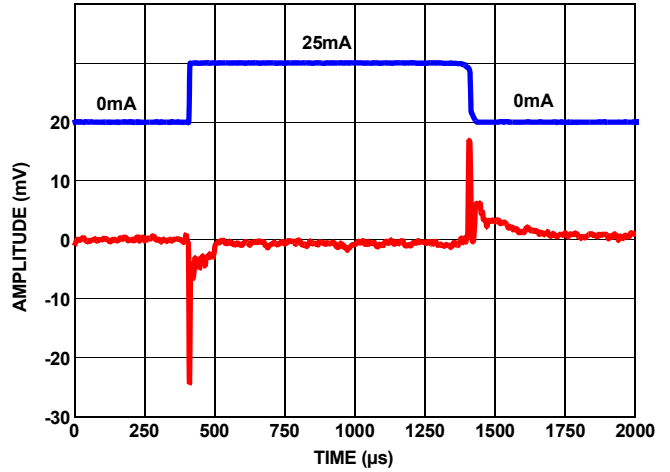

FIGURE 43. LOAD TRANSIENT RESPONSE AT 25mA LOAD AT 1µF

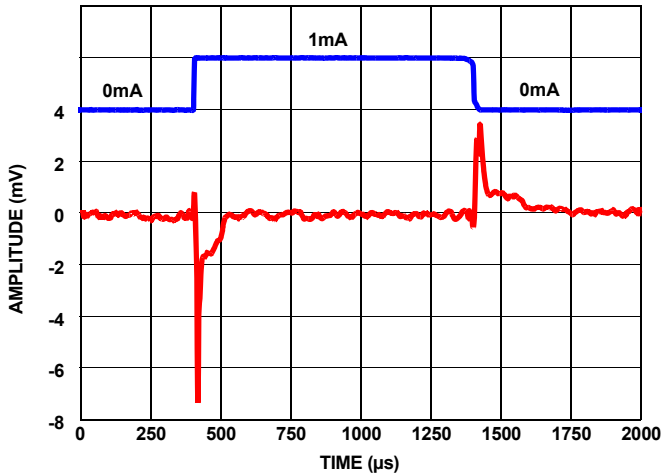

FIGURE 44. LOAD TRANSIENT RESPONSE AT 1mA LOAD AT 1µF

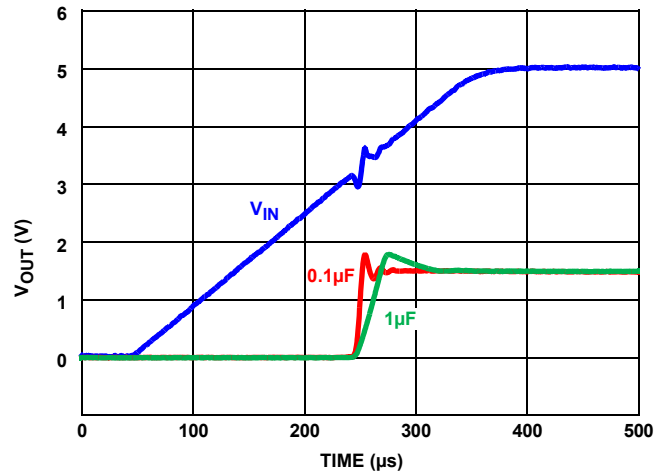

FIGURE 45. TURN-ON TIME

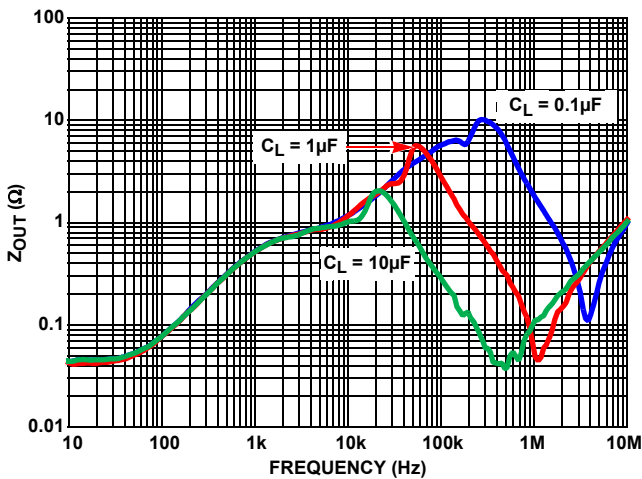

FIGURE 46.  $Z_{OUT}$  vs FREQUENCY

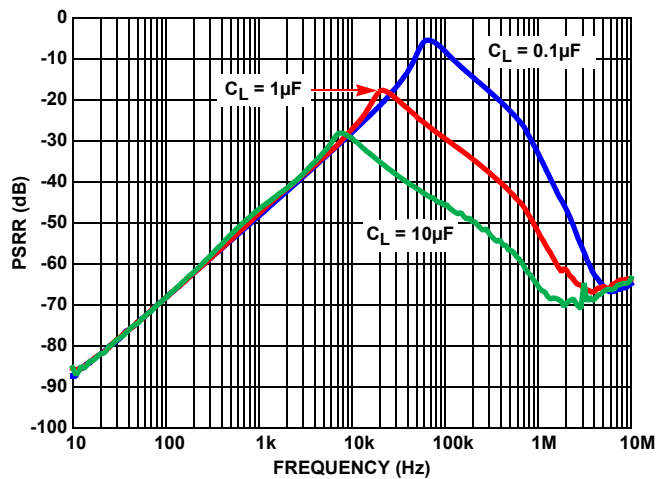

FIGURE 47. RIPPLE REJECTION AT DIFFERENT CAPACITIVE LOADS



## Typical Performance Characteristics Curves ( $V_{OUT} = 1.5V$ )

$V_{IN} = 3.0V$ ,  $I_{OUT} = 0mA$ ,  $T_A = +25^\circ C$  unless otherwise specified. (Continued)

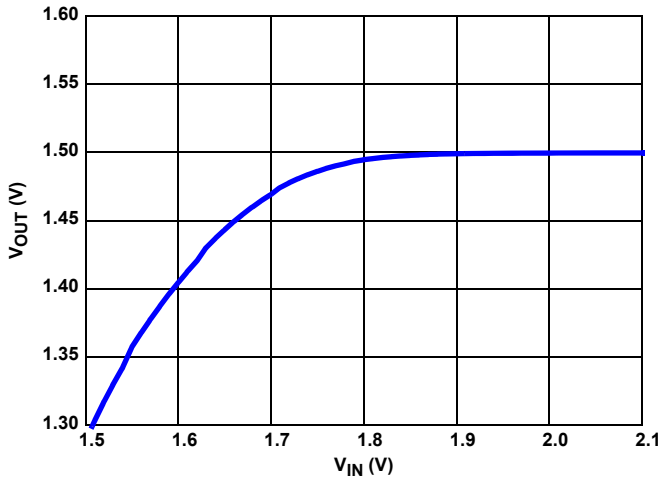

FIGURE 48. DROPOUT (10mA SOURCED LOAD)

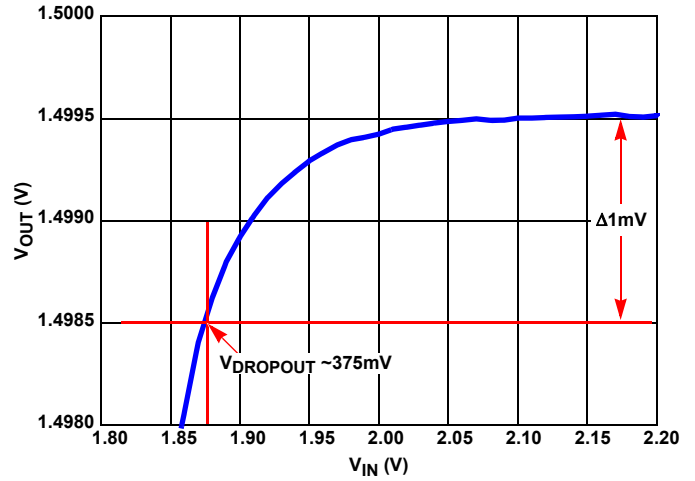

FIGURE 49. DROPOUT ZOOMED (10mA SOURCED LOAD)

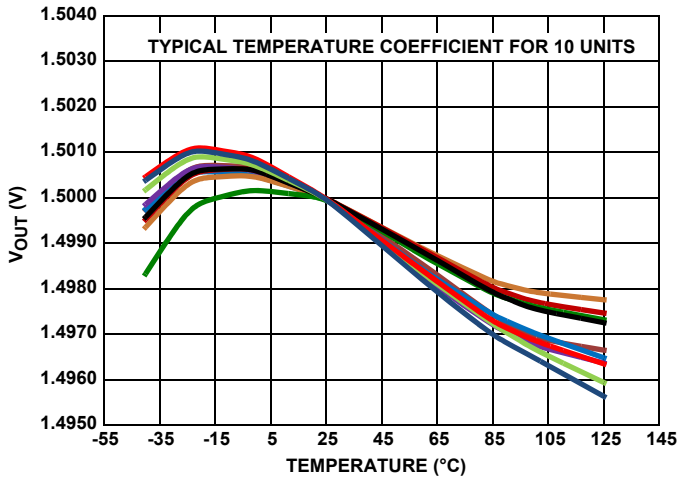

FIGURE 50.  $V_{OUT}$  vs TEMPERATURE

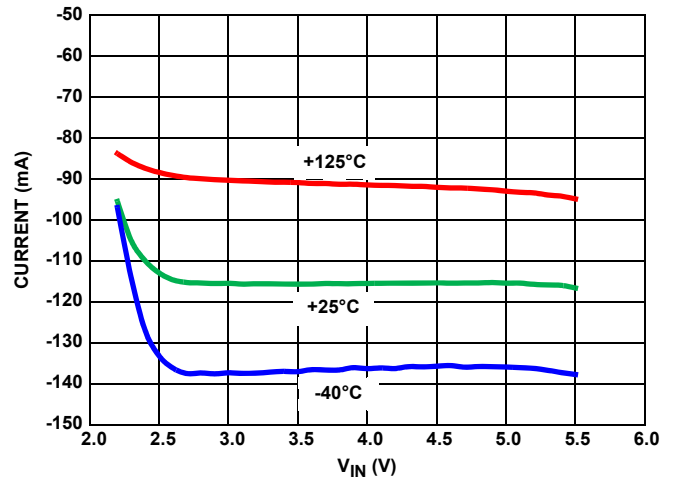

FIGURE 51. SHORT CIRCUIT TO GND

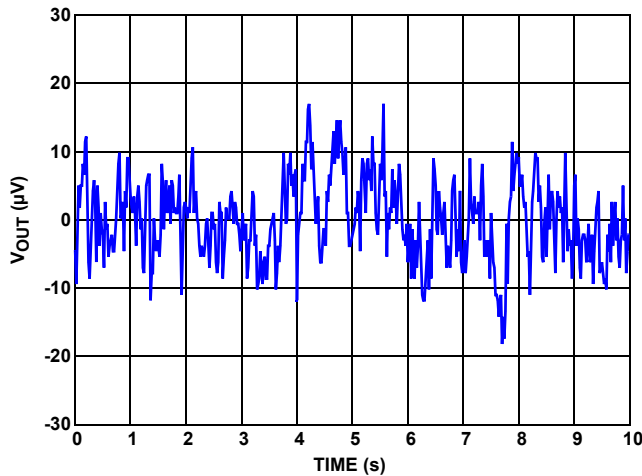

FIGURE 52.  $V_{OUT}$  vs NOISE, 0.1Hz TO 10Hz

Typical Performance Characteristics Curves ( $V_{OUT} = 2.048V$ )

$V_{IN} = 3.0V$ ,  $I_{OUT} = 0mA$ ,  $T_A = +25^\circ C$  unless otherwise specified.

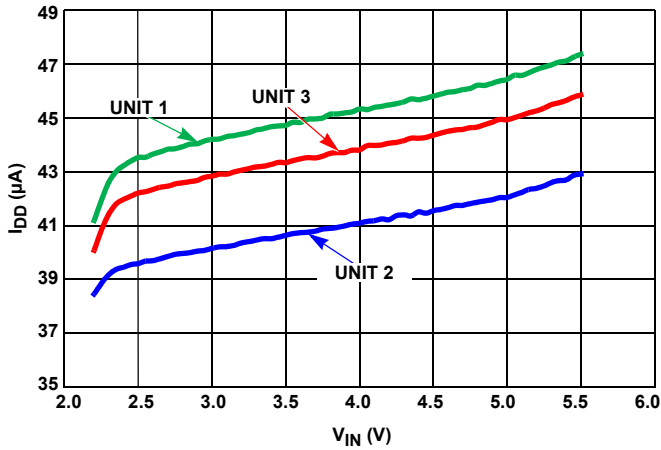

FIGURE 53.  $I_{IN}$  vs  $V_{IN}$ , THREE UNITS

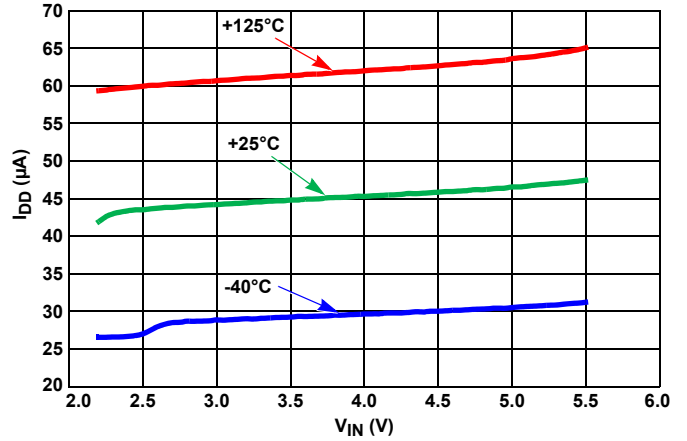

FIGURE 54.  $I_{IN}$  vs  $V_{IN}$ , OVER-TEMPERATURE

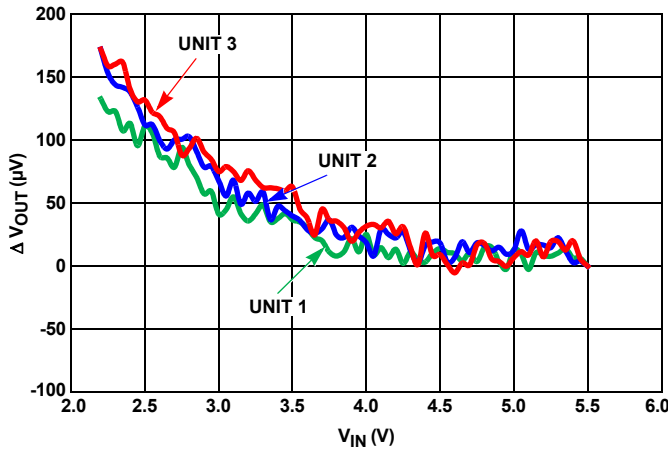

FIGURE 55. LINE REGULATION, THREE UNITS

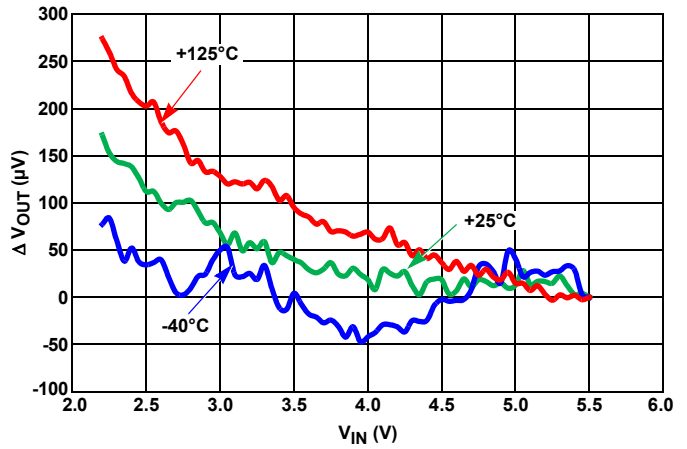

FIGURE 56. LINE REGULATION OVER-TEMPERATURE

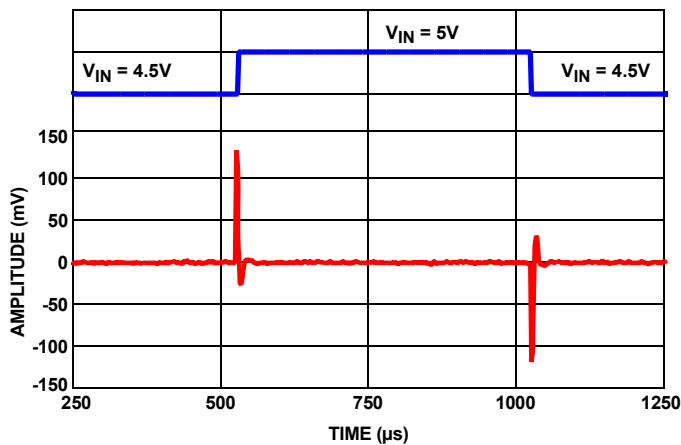

FIGURE 57. LINE TRANSIENT RESPONSE WITH  $0.1\mu F$  LOAD

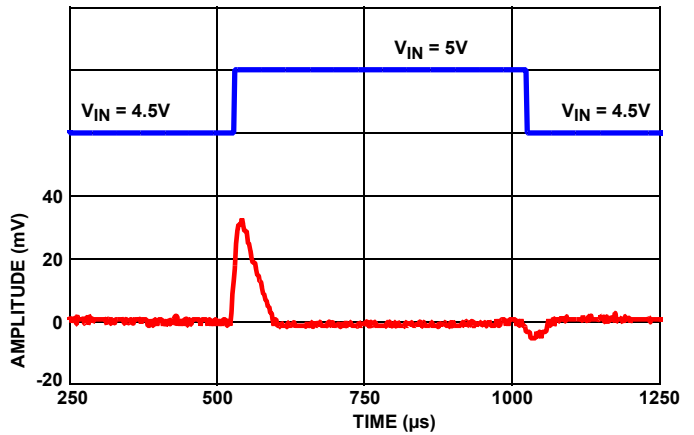

FIGURE 58. LINE TRANSIENT RESPONSE WITH  $10\mu F$  LOAD

## Typical Performance Characteristics Curves ( $V_{OUT} = 2.048V$ )

$V_{IN} = 3.0V$ ,  $I_{OUT} = 0mA$ ,  $T_A = +25^\circ C$  unless otherwise specified. (Continued)

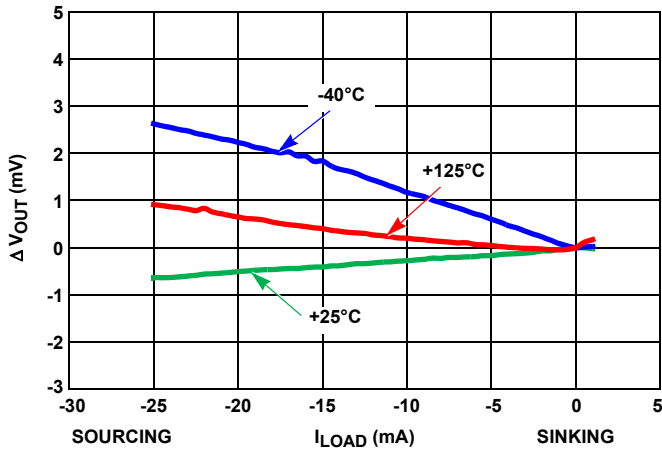

FIGURE 59. LOAD REGULATION OVER-TEMPERATURE

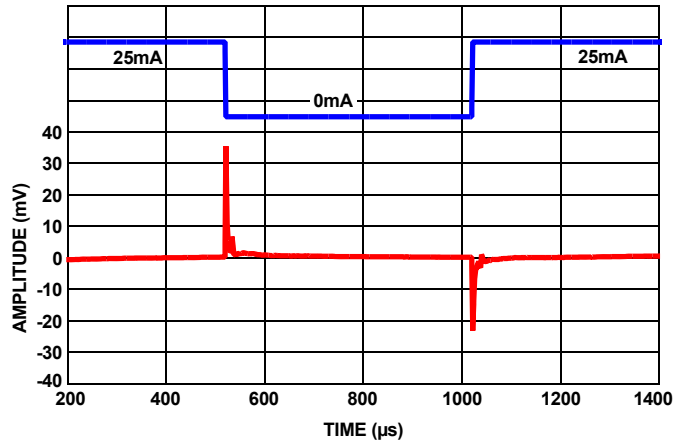

FIGURE 60. LOAD TRANSIENT RESPONSE AT 25mA LOAD AT 1µF

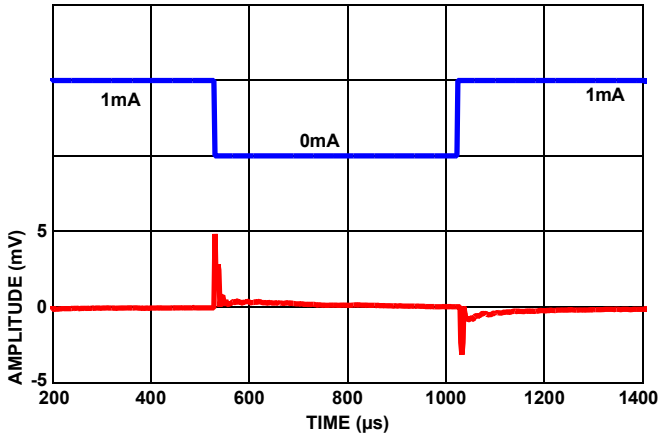

FIGURE 61. LOAD TRANSIENT RESPONSE AT 1mA LOAD AT 1µF

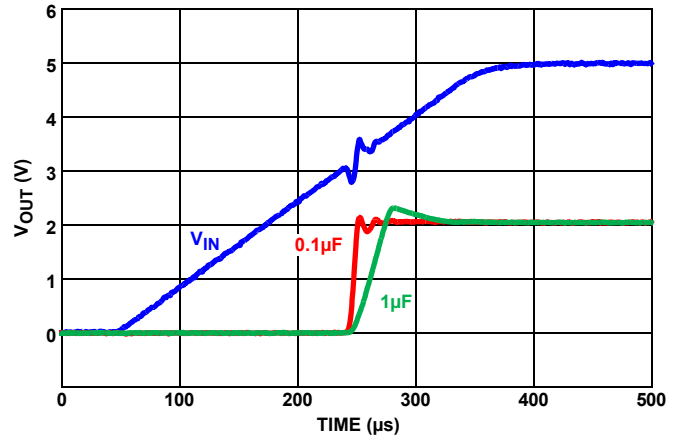

FIGURE 62. TURN-ON TIME

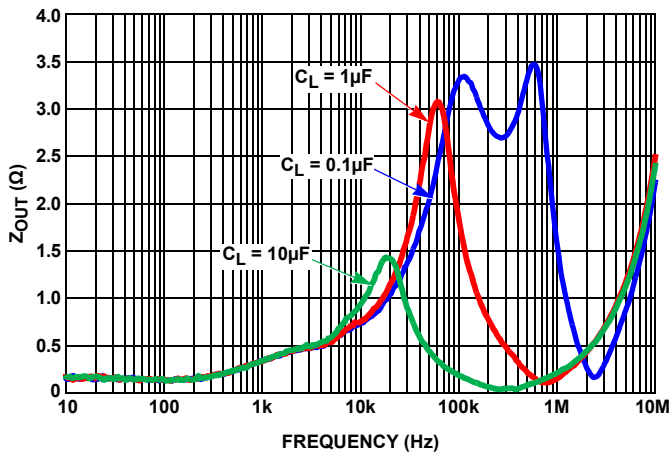

FIGURE 63.  $Z_{OUT}$  vs FREQUENCY

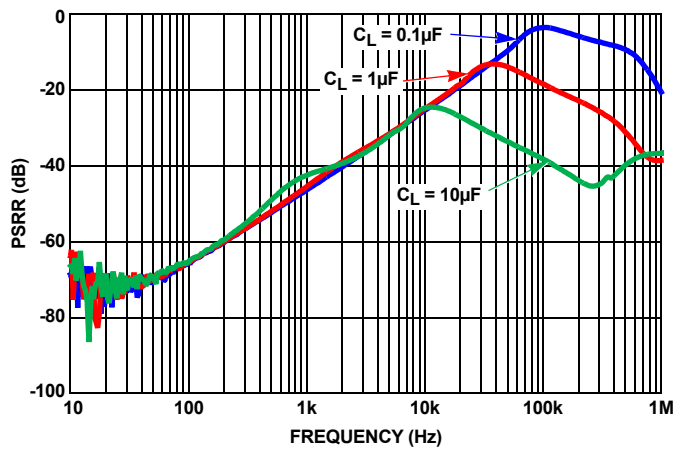

FIGURE 64. RIPPLE REJECTION AT DIFFERENT CAPACITIVE LOADS

## Typical Performance Characteristics Curves ( $V_{OUT} = 2.048V$ )

$V_{IN} = 3.0V$ ,  $I_{OUT} = 0mA$ ,  $T_A = +25^\circ C$  unless otherwise specified. (Continued)

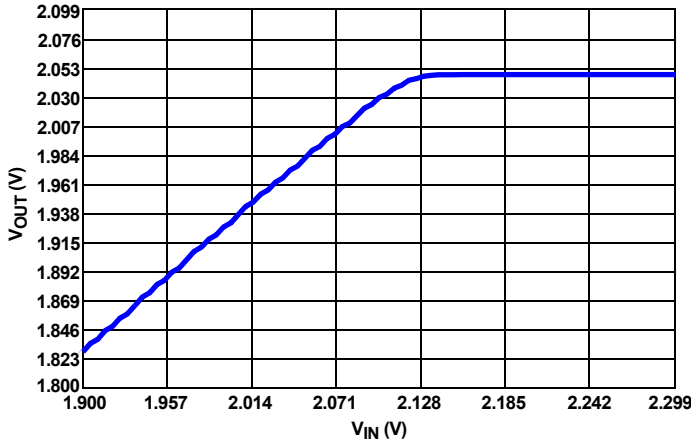

FIGURE 65. DROPOUT (10mA SOURCED LOAD)

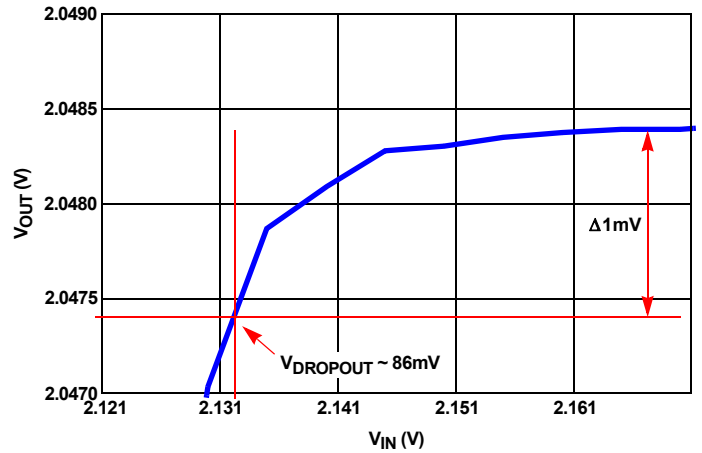

FIGURE 66. DROPOUT ZOOMED (10mA SOURCED LOAD)

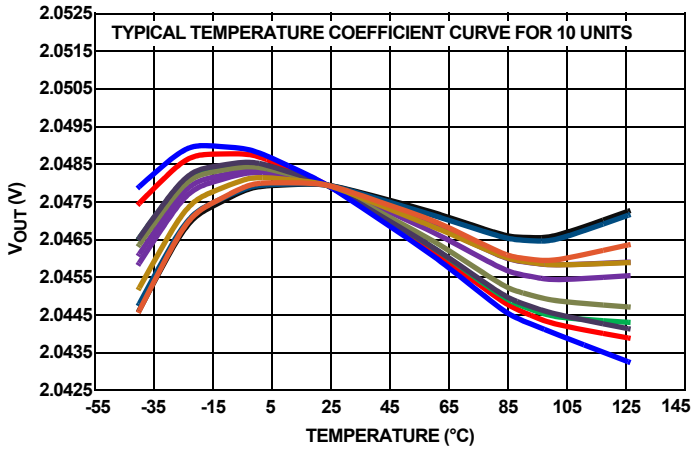

FIGURE 67.  $V_{OUT}$  vs TEMPERATURE

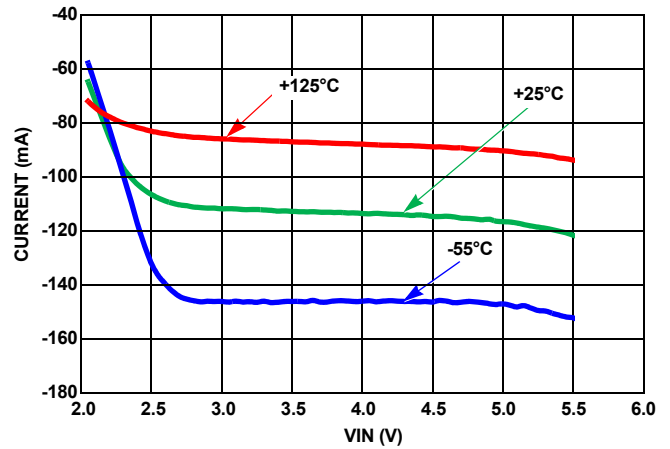

FIGURE 68. SHORT CIRCUIT TO GND

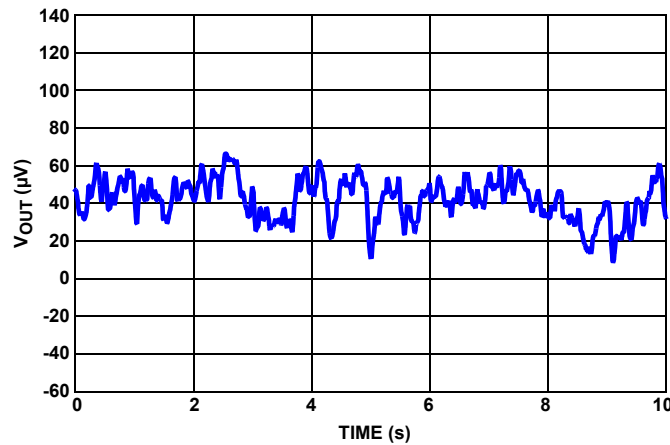

FIGURE 69.  $V_{OUT}$  vs NOISE, 0.1Hz TO 10Hz

Typical Performance Characteristics Curves ( $V_{OUT} = 2.5V$ )

$V_{IN} = 3.0V$ ,  $I_{OUT} = 0mA$ ,  $T_A = +25^\circ C$  unless otherwise specified.

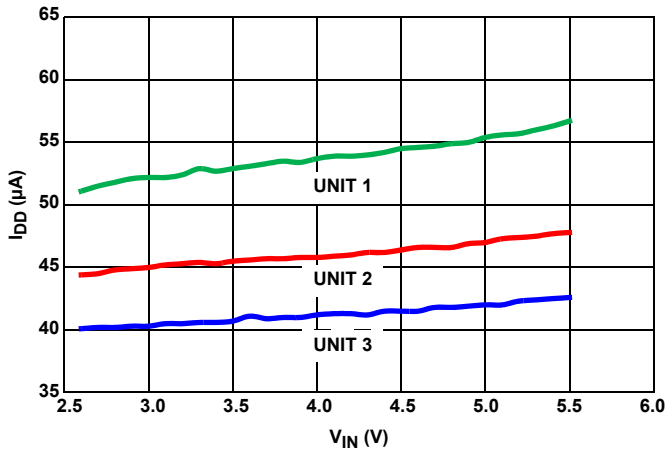

FIGURE 70.  $I_{IN}$  vs  $V_{IN}$ , THREE UNITS

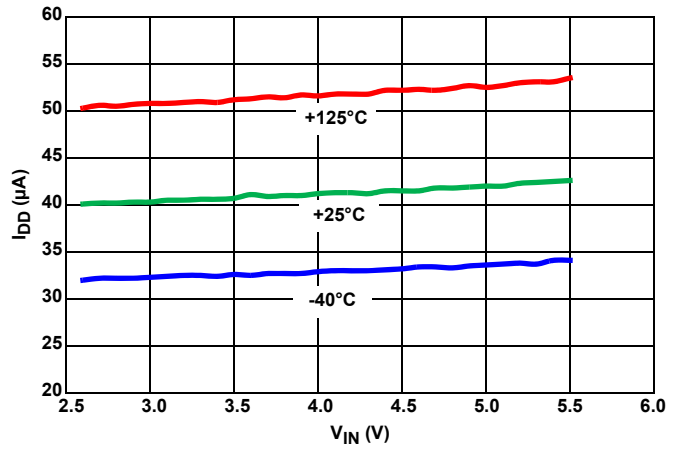

FIGURE 71.  $I_{IN}$  vs  $V_{IN}$ , OVER-TEMPERATURE

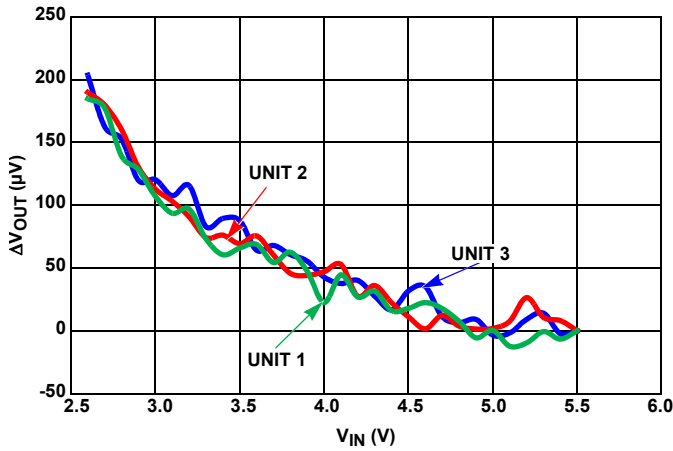

FIGURE 72. LINE REGULATION, THREE UNITS

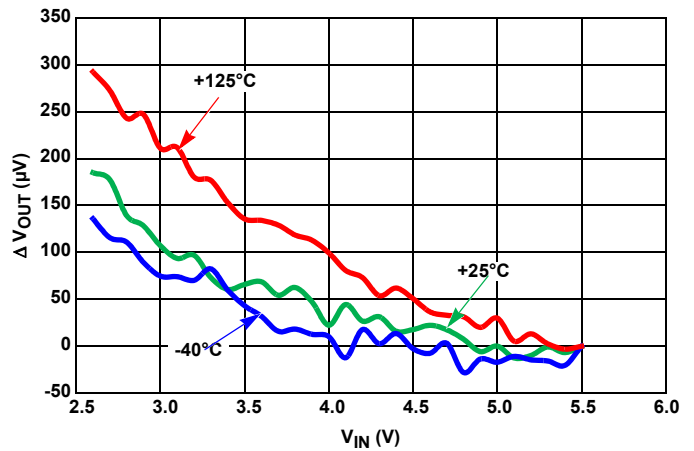

FIGURE 73. LINE REGULATION OVER-TEMPERATURE

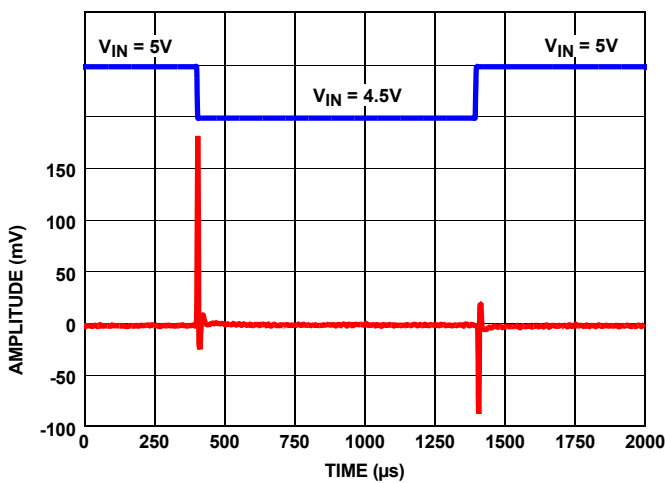

FIGURE 74. LINE TRANSIENT RESPONSE WITH  $0.1\mu F$  LOAD

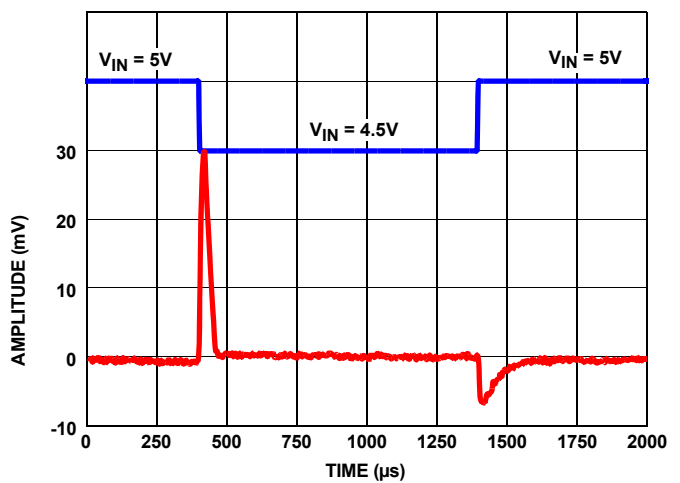

FIGURE 75. LINE TRANSIENT RESPONSE WITH  $10\mu F$  LOAD

Typical Performance Characteristics Curves ( $V_{OUT} = 2.5V$ )

$V_{IN} = 3.0V$ ,  $I_{OUT} = 0mA$ ,  $T_A = +25^\circ C$  unless otherwise specified. (Continued)

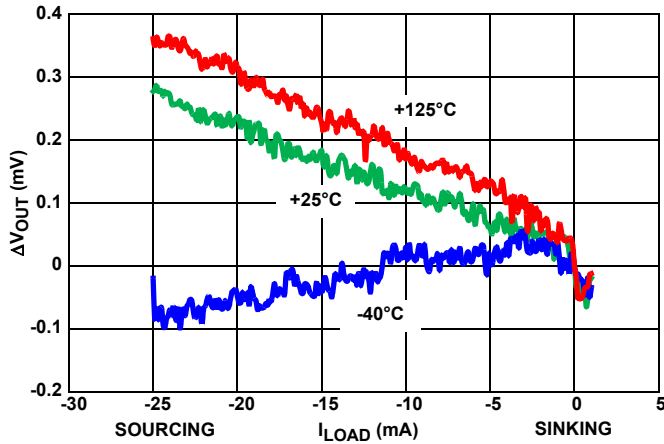

FIGURE 76. LOAD REGULATION OVER-TEMPERATURE

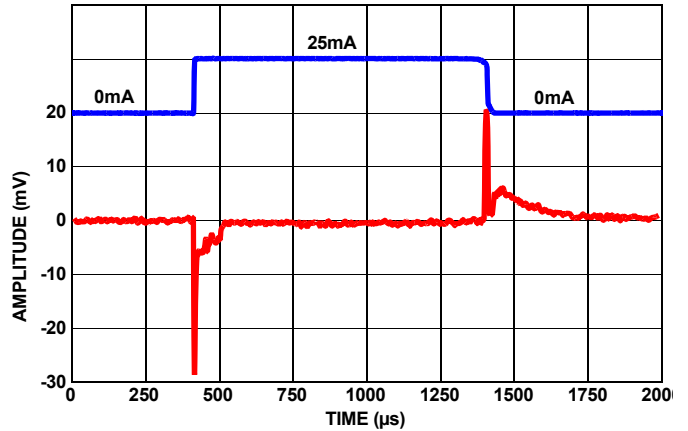

FIGURE 77. LOAD TRANSIENT RESPONSE AT 25mA LOAD AT 1μF

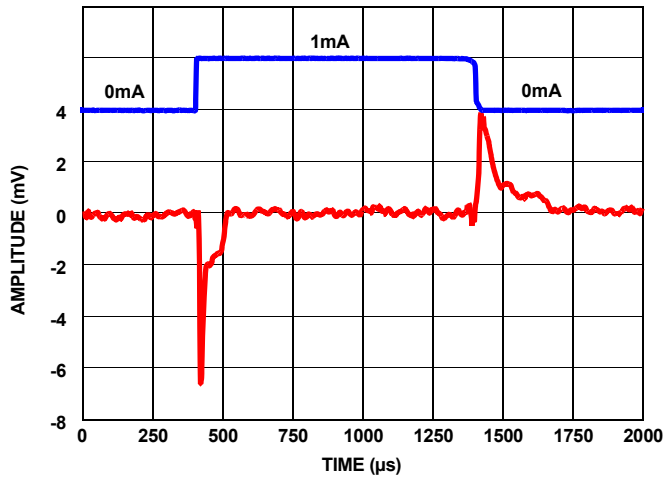

FIGURE 78. LOAD TRANSIENT RESPONSE AT 1mA LOAD AT 1μF

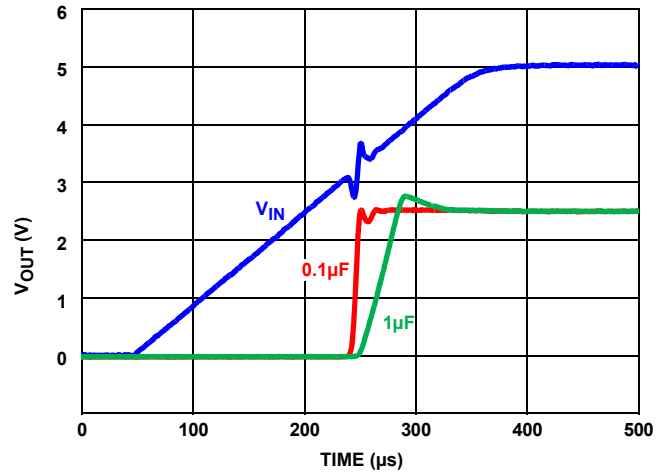

FIGURE 79. TURN-ON TIME

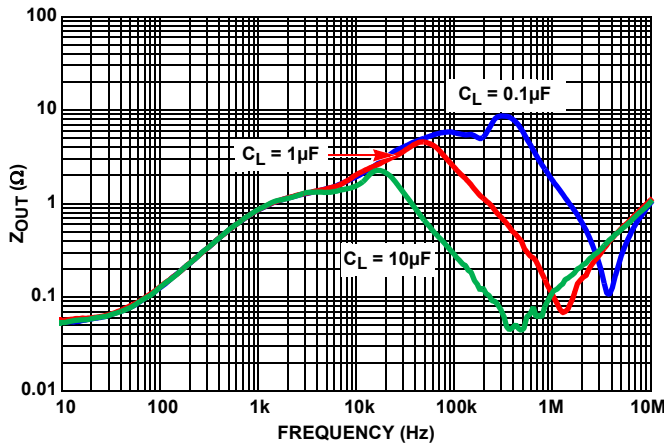

FIGURE 80.  $Z_{OUT}$  vs FREQUENCY

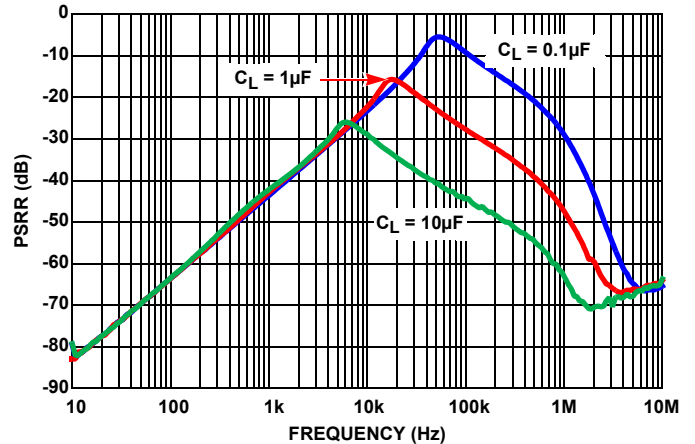

FIGURE 81. RIPPLE REJECTION AT DIFFERENT CAPACITIVE LOADS

## Typical Performance Characteristics Curves ( $V_{OUT} = 2.5V$ )

$V_{IN} = 3.0V$ ,  $I_{OUT} = 0mA$ ,  $T_A = +25^\circ C$  unless otherwise specified. (Continued)

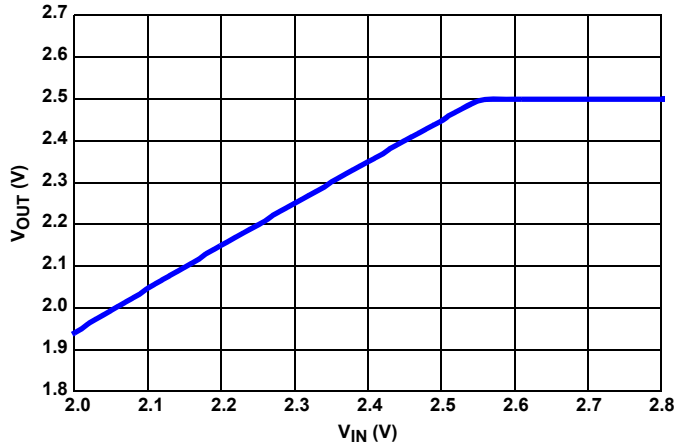

FIGURE 82. DROPOUT (10mA SOURCED LOAD)

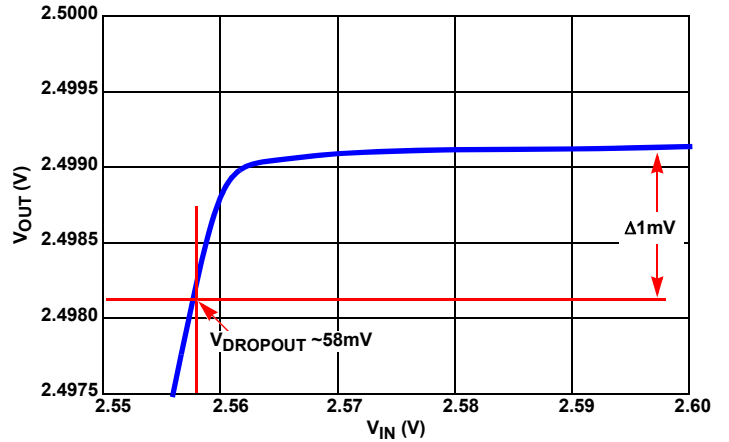

FIGURE 83. DROPOUT ZOOMED (10mA SOURCED LOAD)

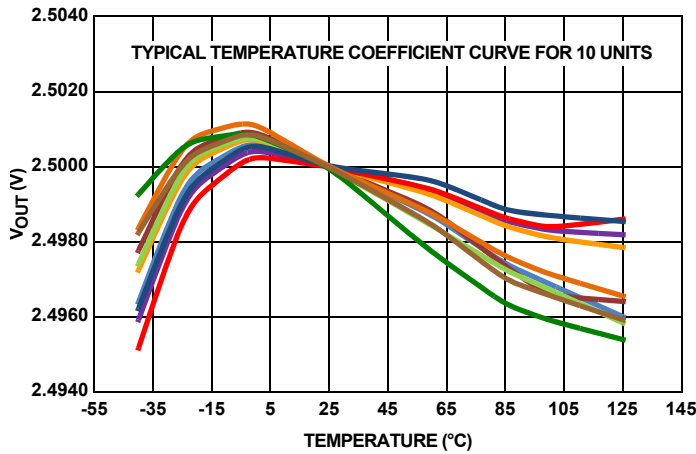

FIGURE 84.  $V_{OUT}$  vs TEMPERATURE

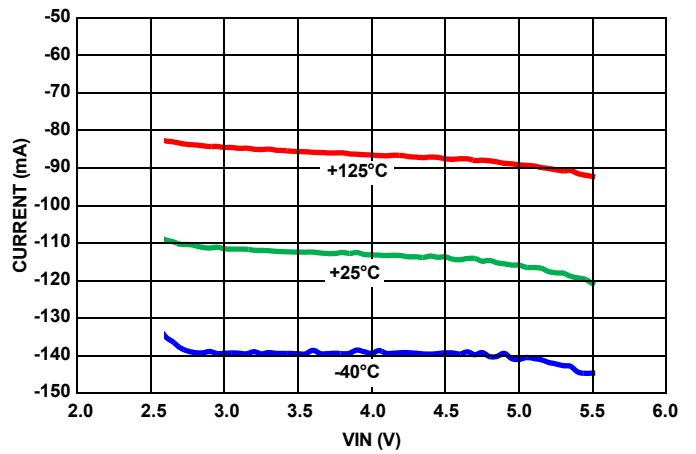

FIGURE 85. SHORT CIRCUIT TO GND

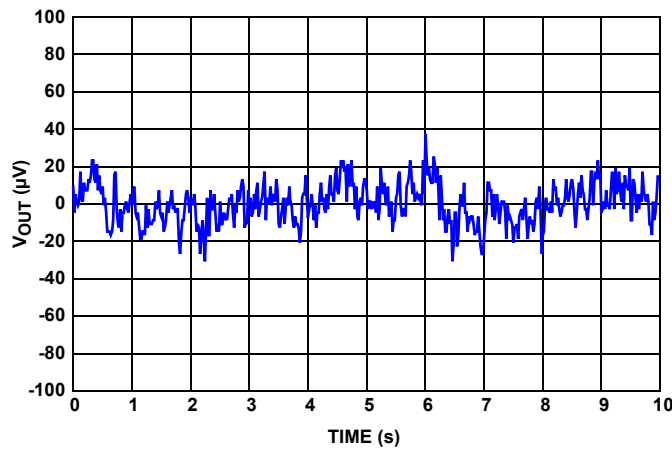

FIGURE 86.  $V_{OUT}$  vs NOISE, 0.1Hz TO 10Hz

Typical Performance Characteristics Curves ( $V_{OUT} = 3.0V$ )

$V_{IN} = 5.0V$ ,  $I_{OUT} = 0mA$ ,  $T_A = +25^\circ C$  unless otherwise specified.

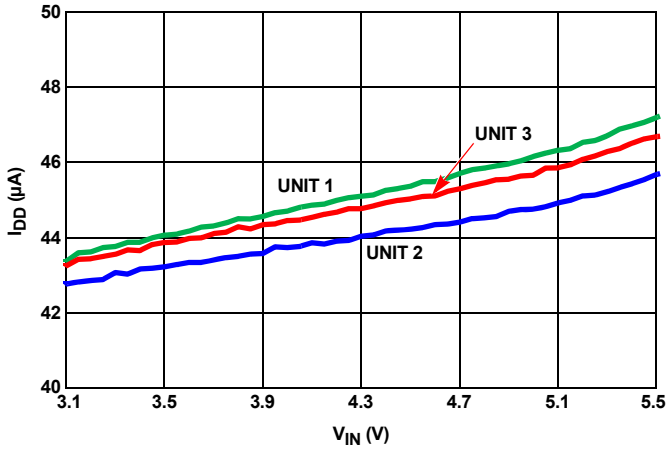

FIGURE 87.  $I_{IN}$  vs  $V_{IN}$ , THREE UNITS

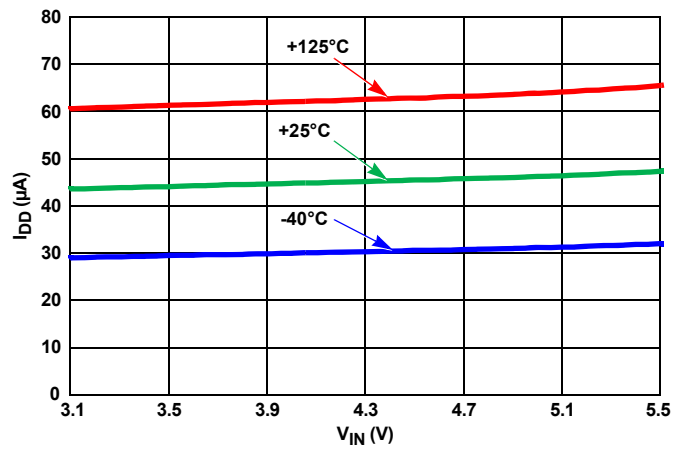

FIGURE 88.  $I_{IN}$  vs  $V_{IN}$ , OVER-TEMPERATURE

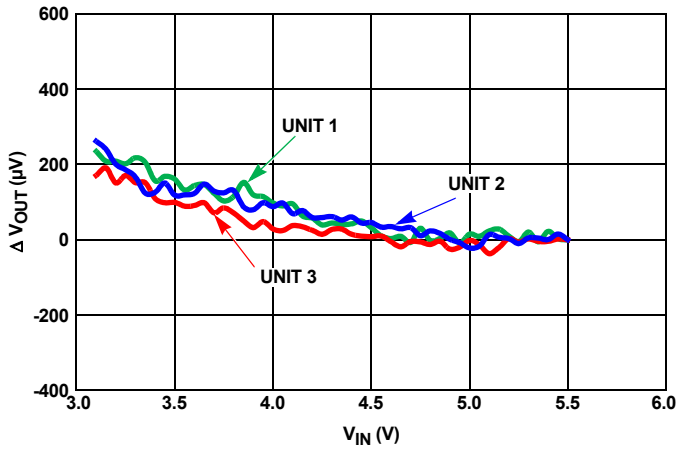

FIGURE 89. LINE REGULATION, THREE UNITS

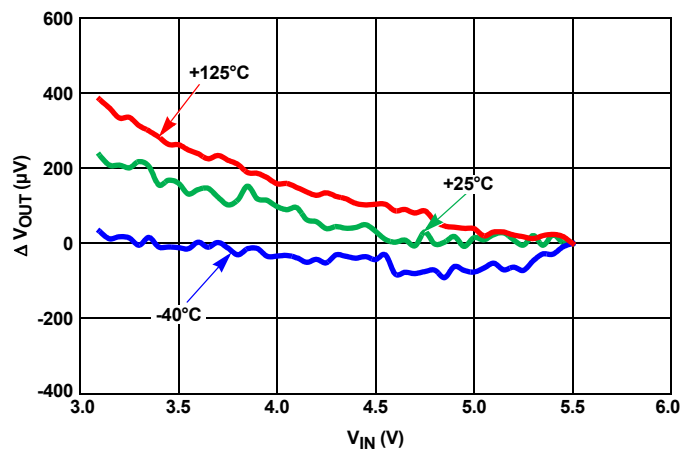

FIGURE 90. LINE REGULATION OVER-TEMPERATURE

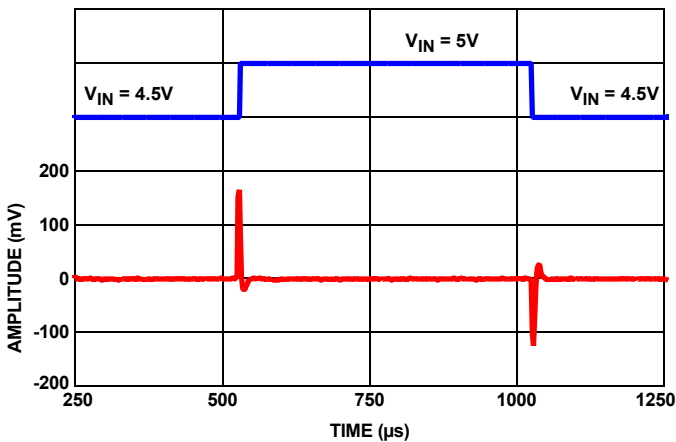

FIGURE 91. LINE TRANSIENT WITH  $0.1\mu F$  LOAD

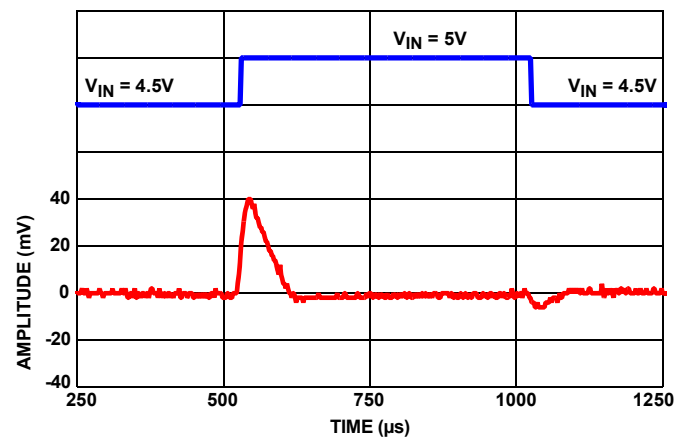

FIGURE 92. LINE TRANSIENT RESPONSE WITH  $10\mu F$  LOAD



## Typical Performance Characteristics Curves ( $V_{OUT} = 3.0V$ )

$V_{IN} = 5.0V$ ,  $I_{OUT} = 0mA$ ,  $T_A = +25^\circ C$  unless otherwise specified. (Continued)

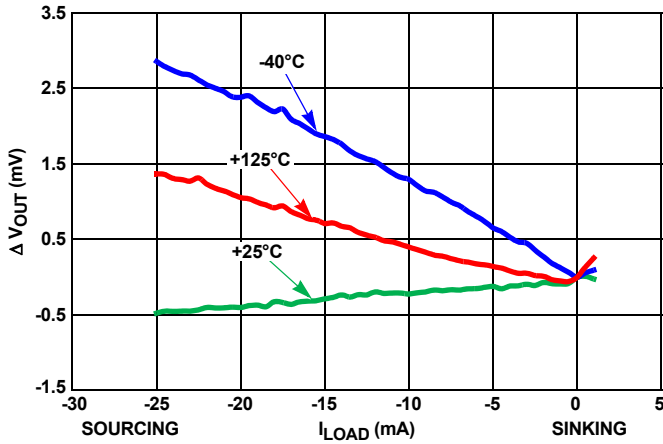

FIGURE 93. LOAD REGULATION OVER-TEMPERATURE

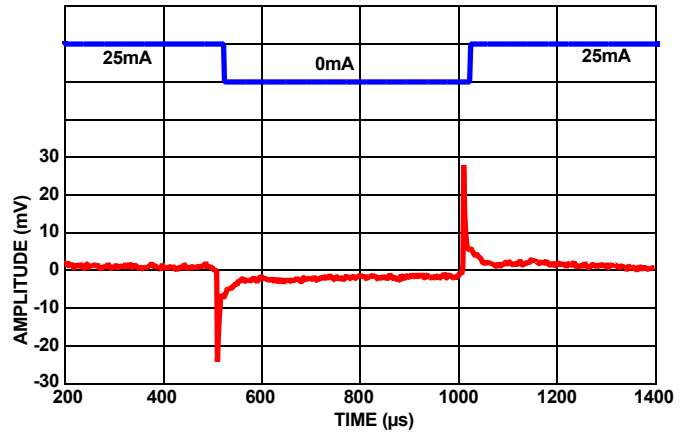

FIGURE 94. LOAD TRANSIENT RESPONSE AT 25mA LOAD AT 1 $\mu$ F

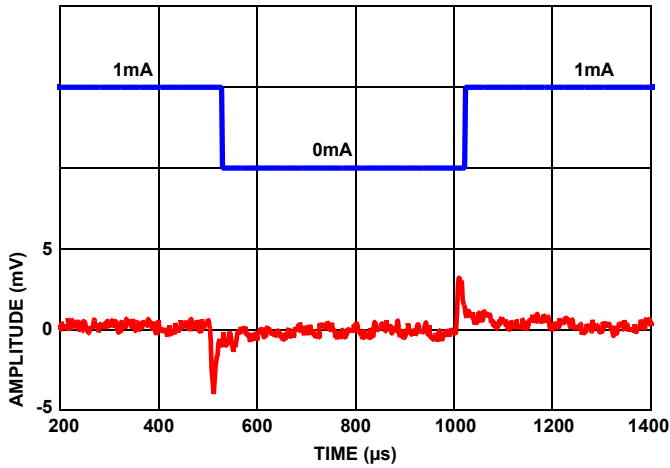

FIGURE 95. LOAD TRANSIENT RESPONSE AT 1mA LOAD AT 1 $\mu$ F

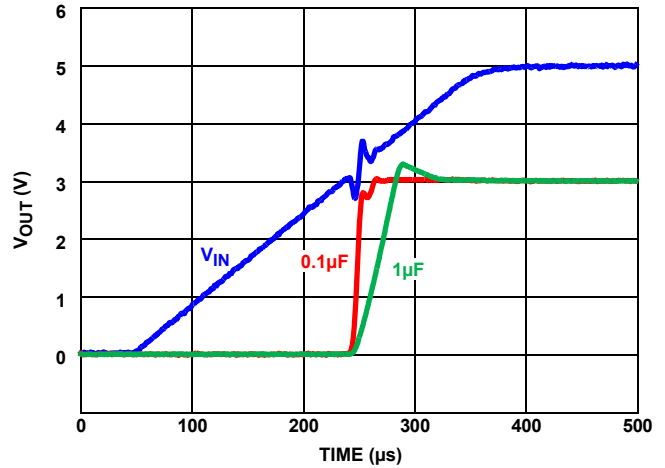

FIGURE 96. TURN-ON TIME

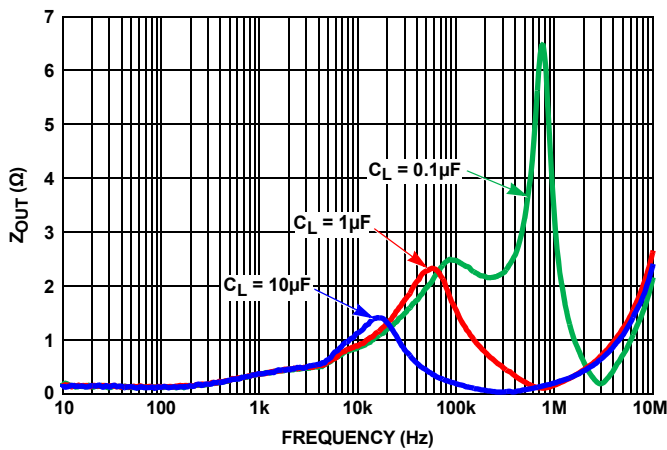

FIGURE 97.  $Z_{OUT}$  vs FREQUENCY

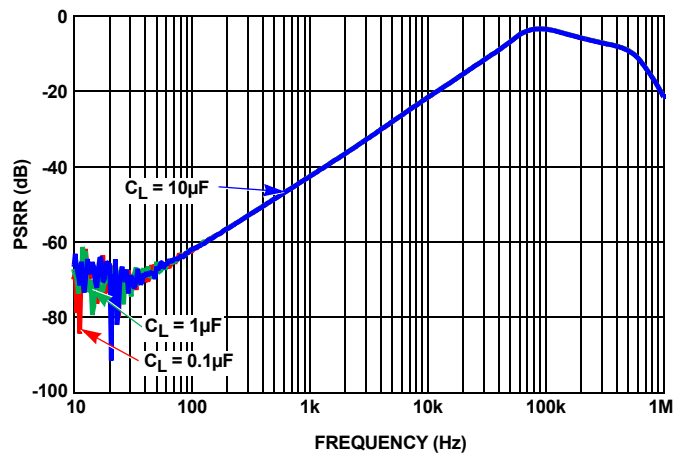

FIGURE 98. RIPPLE REJECTION AT DIFFERENT CAPACITIVE LOADS

## Typical Performance Characteristics Curves ( $V_{OUT} = 3.0V$ )

$V_{IN} = 5.0V$ ,  $I_{OUT} = 0mA$ ,  $T_A = +25^\circ C$  unless otherwise specified. (Continued)

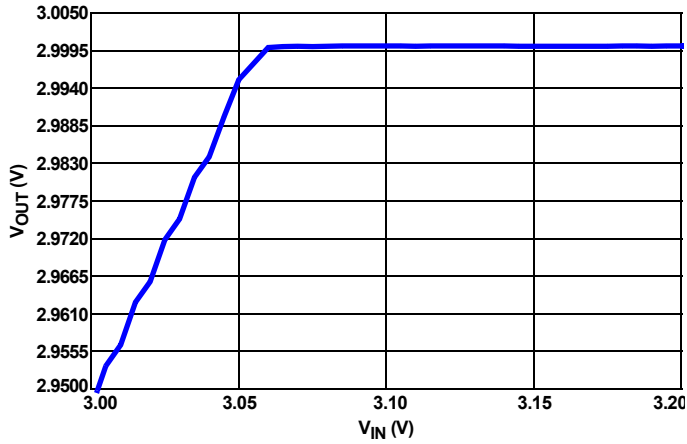

FIGURE 99. DROPOUT (10mA SOURCED LOAD)

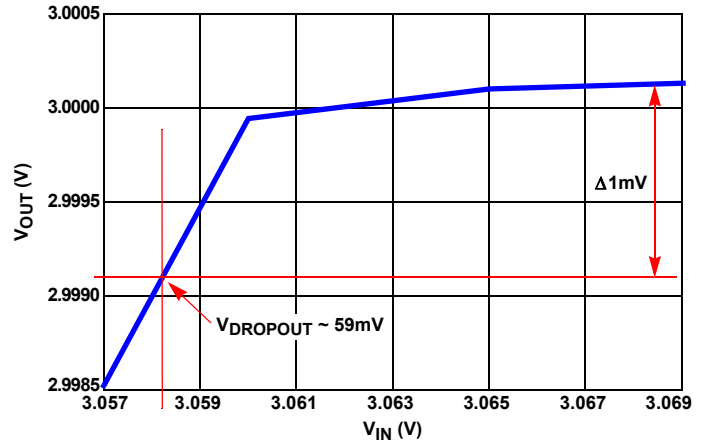

FIGURE 100. DROPOUT ZOOMED (10mA SOURCED LOAD)

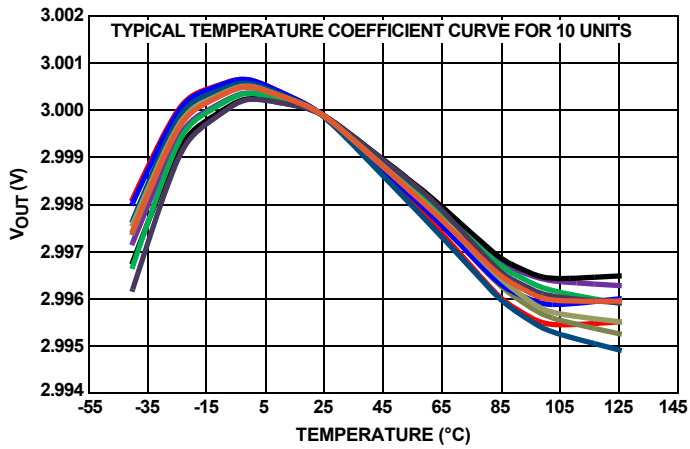

FIGURE 101.  $V_{OUT}$  vs TEMPERATURE

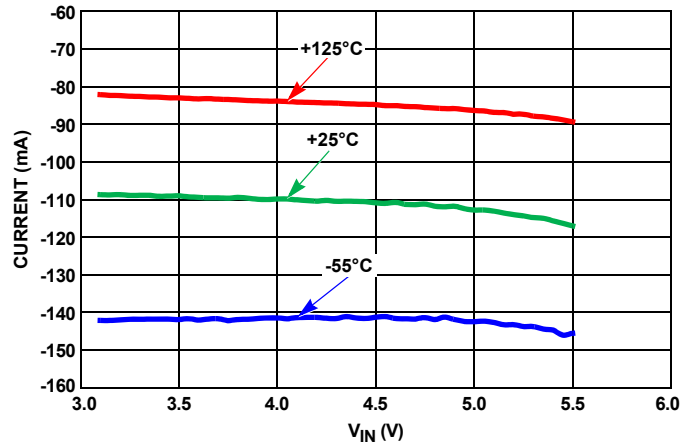

FIGURE 102. SHORT CIRCUIT TO GND

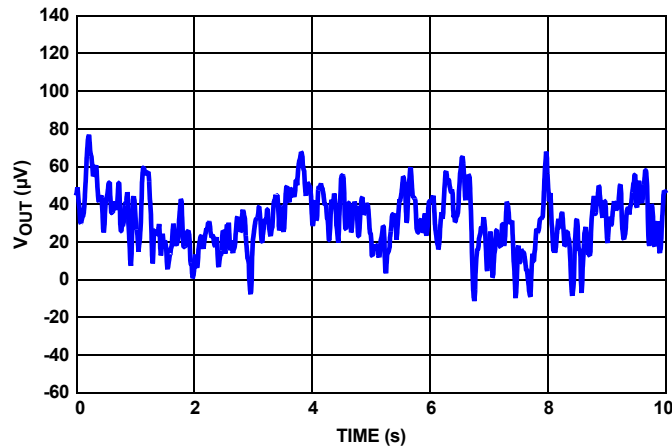

FIGURE 103.  $V_{OUT}$  vs NOISE, 0.1Hz TO 10Hz

## Typical Performance Characteristics Curves ( $V_{OUT} = 3.3V$ )

$V_{IN} = 5.0V$ ,  $I_{OUT} = 0mA$ ,  $T_A = +25^\circ C$  unless otherwise specified.

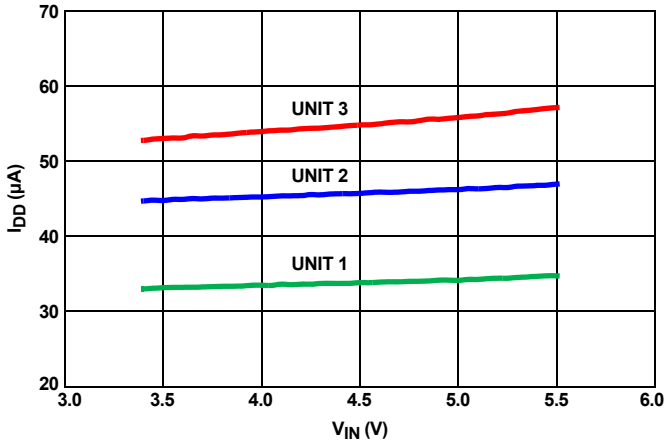

FIGURE 104.  $I_{IN}$  vs  $V_{IN}$ , THREE UNITS

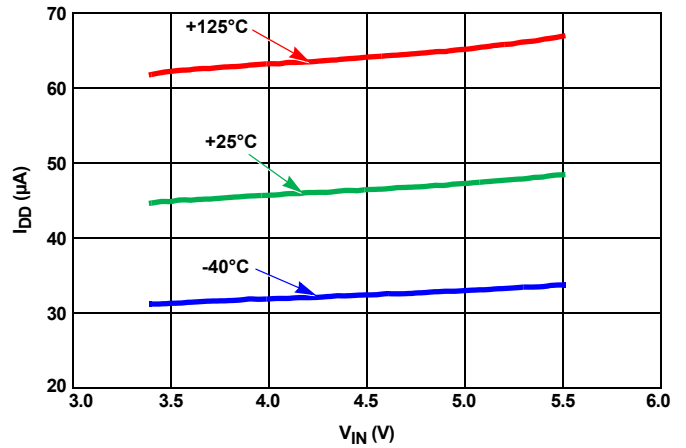

FIGURE 105.  $I_{IN}$  vs  $V_{IN}$ , OVER-TEMPERATURE

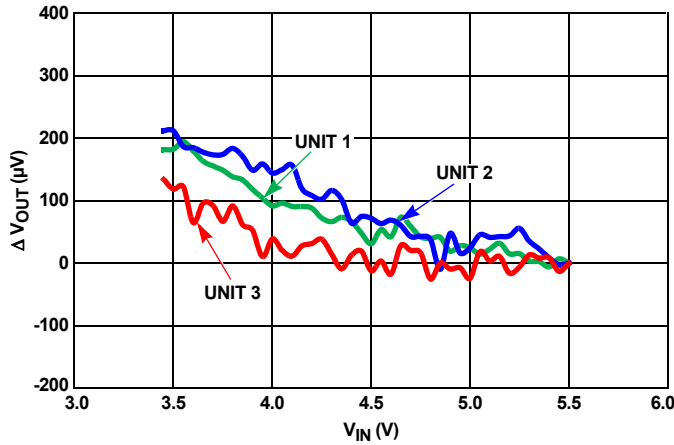

FIGURE 106. LINE REGULATION, THREE UNITS

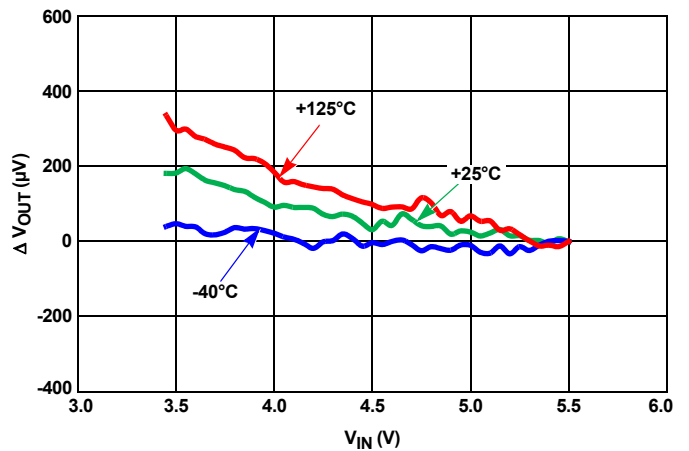

FIGURE 107. LINE REGULATION OVER-TEMPERATURE

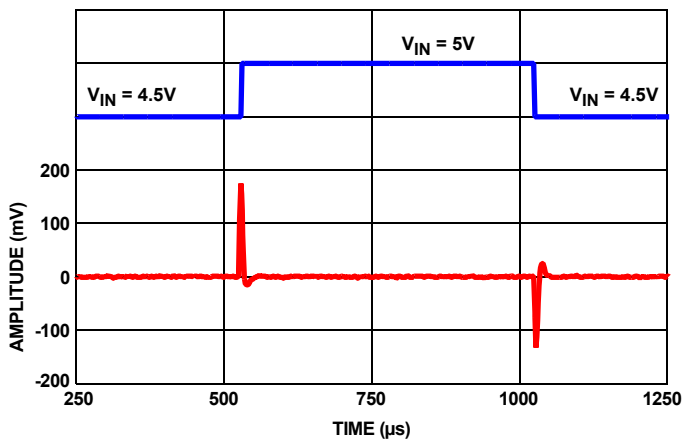

FIGURE 108. LINE TRANSIENT WITH  $0.1\mu F$  LOAD

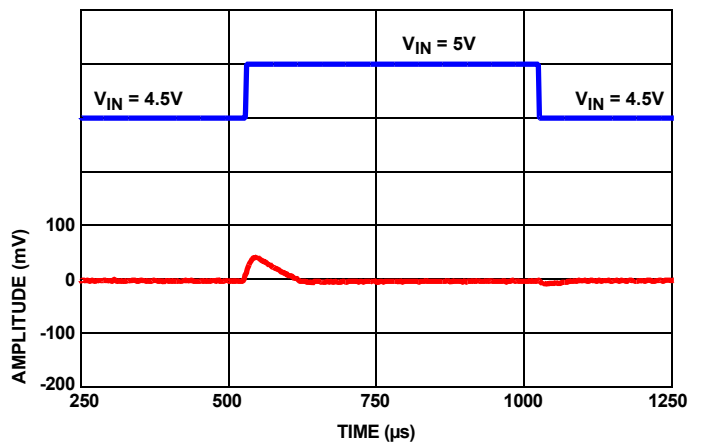

FIGURE 109. LINE TRANSIENT RESPONSE WITH  $10\mu F$  LOAD

Typical Performance Characteristics Curves ( $V_{OUT} = 3.3V$ )

$V_{IN} = 5.0V$ ,  $I_{OUT} = 0mA$ ,  $T_A = +25^\circ C$  unless otherwise specified. (Continued)

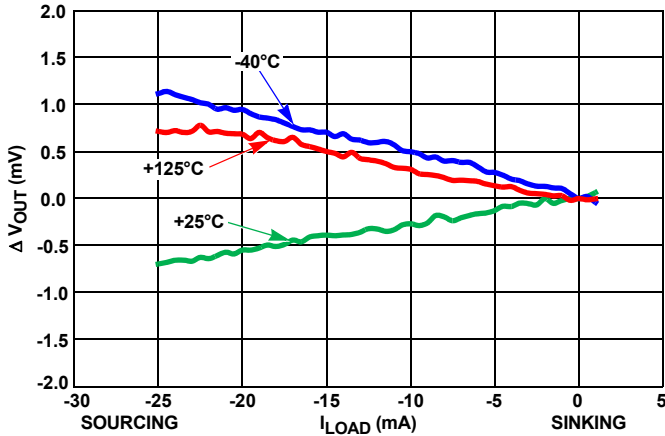

FIGURE 110. LOAD REGULATION OVER-TEMPERATURE

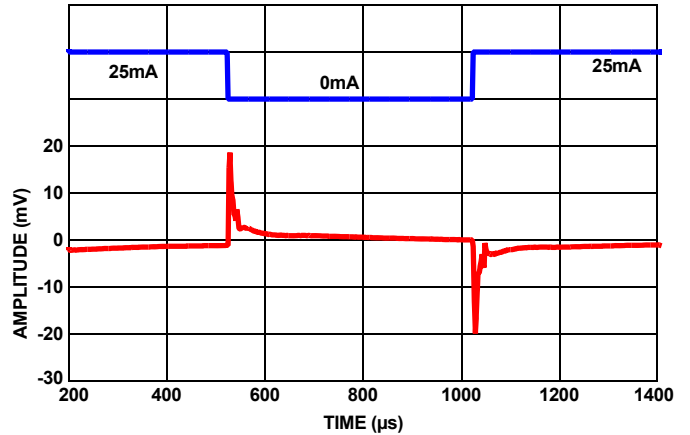

FIGURE 111. LOAD TRANSIENT RESPONSE AT 25mA LOAD AT  $1\mu F$

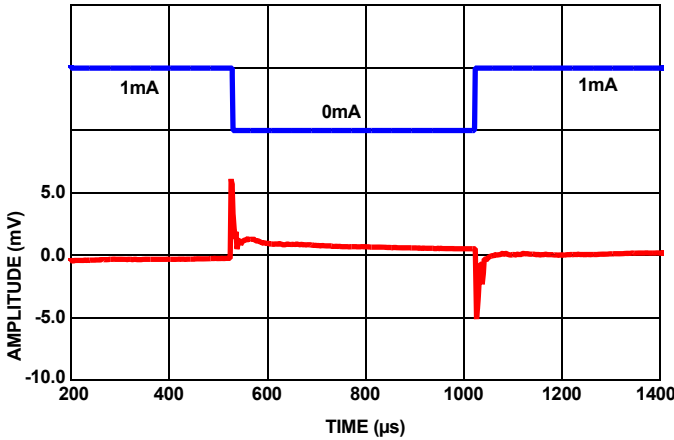

FIGURE 112. LOAD TRANSIENT RESPONSE AT 1mA LOAD AT  $1\mu F$

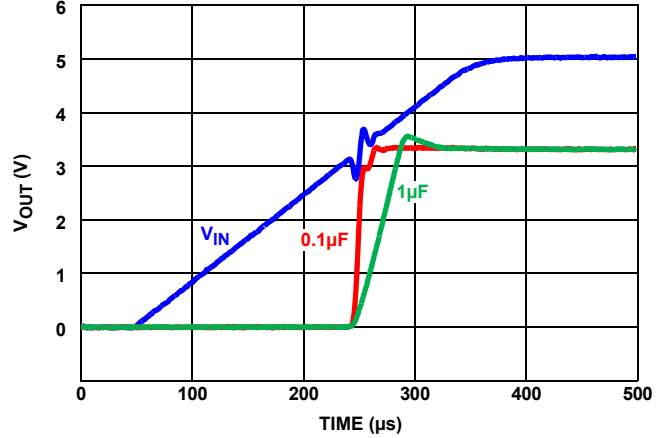

FIGURE 113. TURN-ON TIME

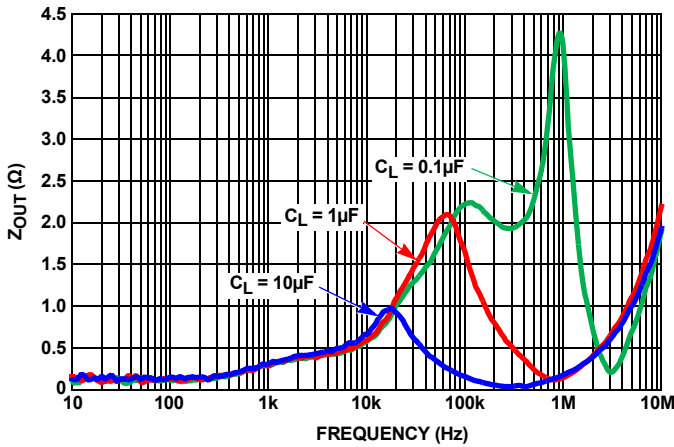

FIGURE 114.  $Z_{OUT}$  vs FREQUENCY

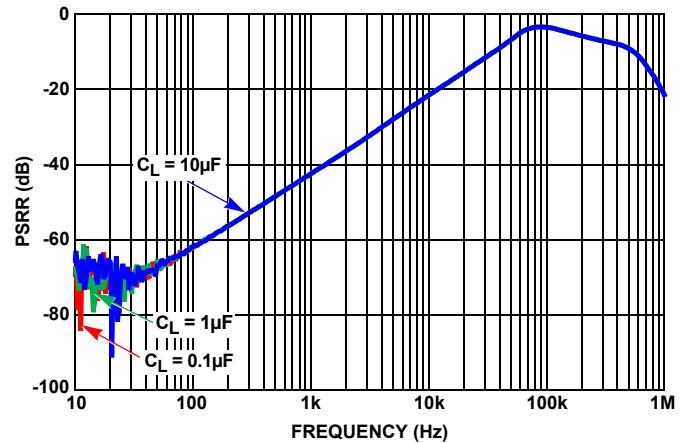

FIGURE 115. RIPPLE REJECTION AT DIFFERENT CAPACITIVE LOADS

## Typical Performance Characteristics Curves ( $V_{OUT} = 3.3V$ )

$V_{IN} = 5.0V$ ,  $I_{OUT} = 0mA$ ,  $T_A = +25^\circ C$  unless otherwise specified. (Continued)

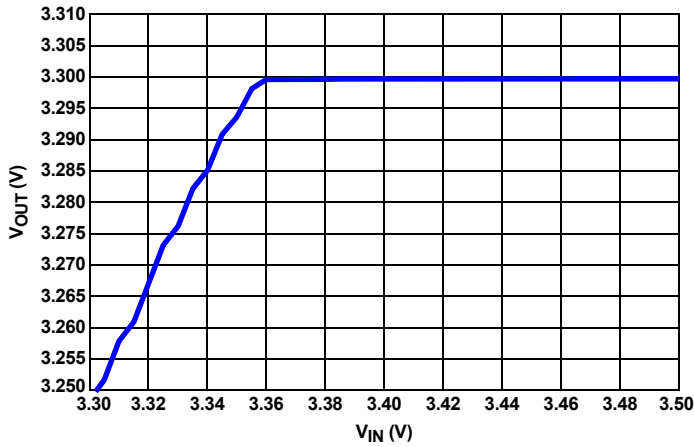

FIGURE 116. DROPOUT (10mA SOURCED LOAD)

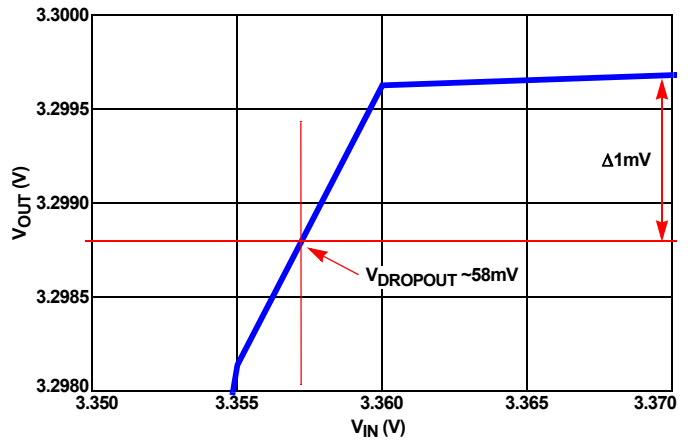

FIGURE 117. DROPOUT ZOOMED (10mA SOURCED LOAD)

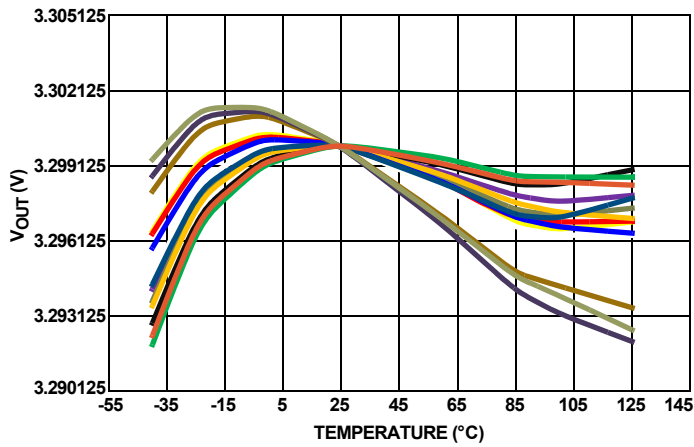

FIGURE 118.  $V_{OUT}$  vs TEMPERATURE

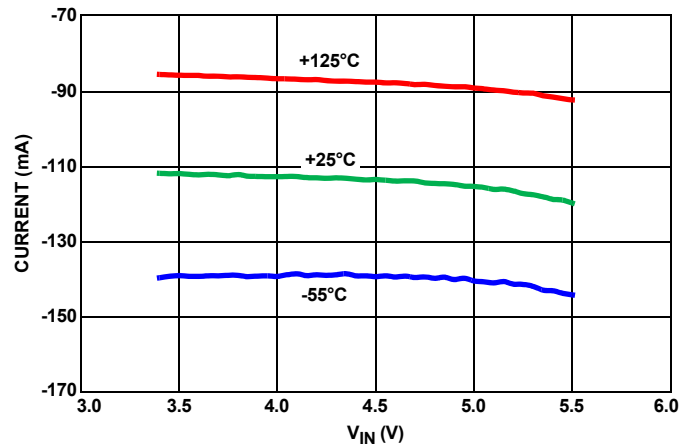

FIGURE 119. SHORT CIRCUIT TO GND

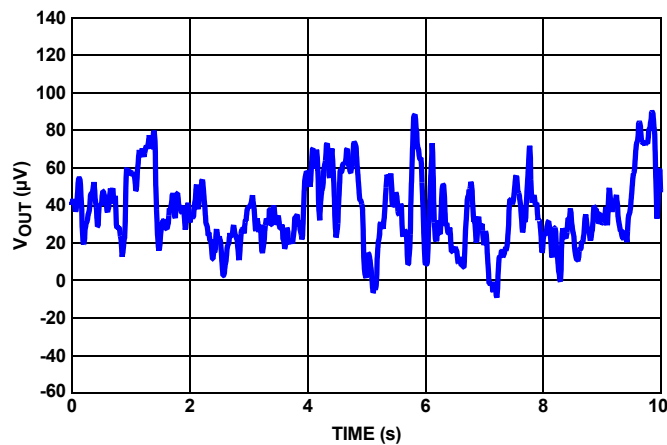

FIGURE 120.  $V_{OUT}$  vs NOISE, 0.1Hz TO 10Hz

## Typical Performance Characteristics Curves ( $V_{OUT} = 4.096V$ )

$V_{IN} = 3.0V$ ,  $I_{OUT} = 0mA$ ,  $T_A = +25^\circ C$  unless otherwise specified.

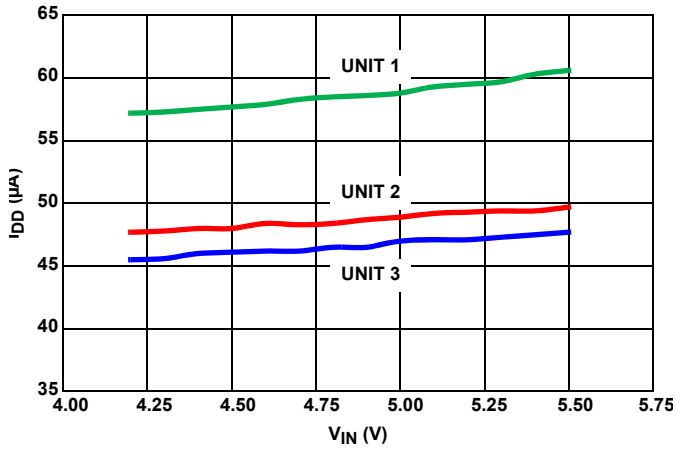

FIGURE 121.  $I_{IN}$  vs  $V_{IN}$ , THREE UNITS

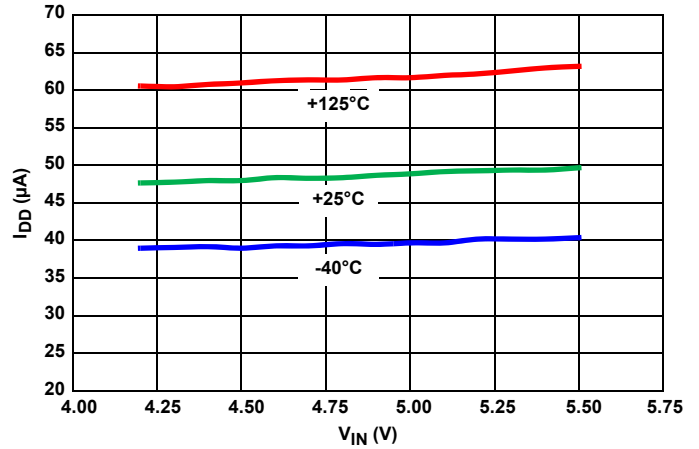

FIGURE 122.  $I_{IN}$  vs  $V_{IN}$ , OVER-TEMPERATURE

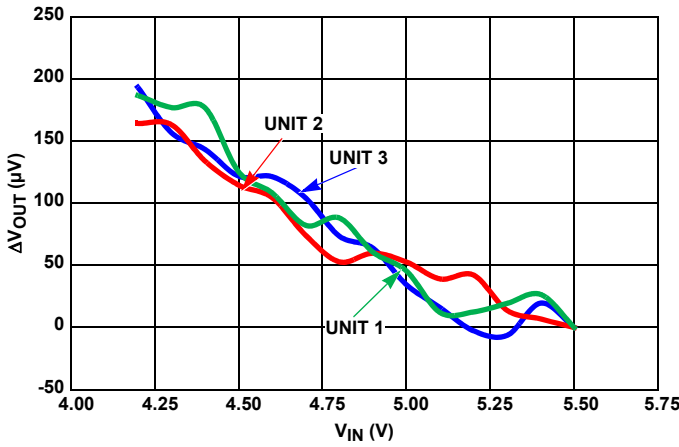

FIGURE 123. LINE REGULATION, THREE UNITS

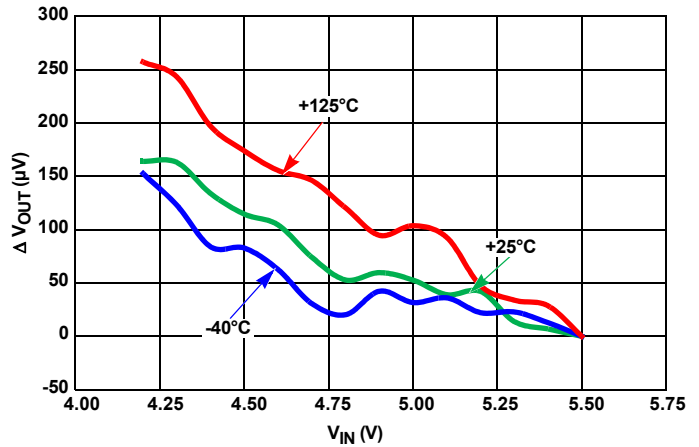

FIGURE 124. LINE REGULATION OVER-TEMPERATURE

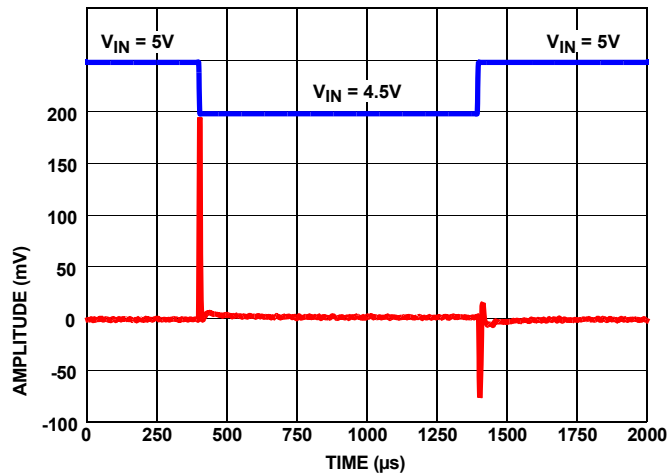

FIGURE 125. LINE TRANSIENT RESPONSE WITH  $0.1\mu F$  LOAD

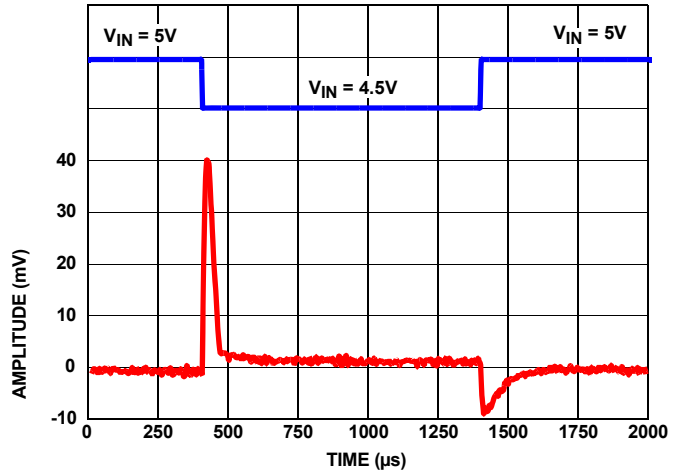

FIGURE 126. LINE TRANSIENT RESPONSE WITH  $10\mu F$  LOAD

Typical Performance Characteristics Curves ( $V_{OUT} = 4.096V$ )

$V_{IN} = 3.0V$ ,  $I_{OUT} = 0mA$ ,  $T_A = +25^\circ C$  unless otherwise specified. (Continued)

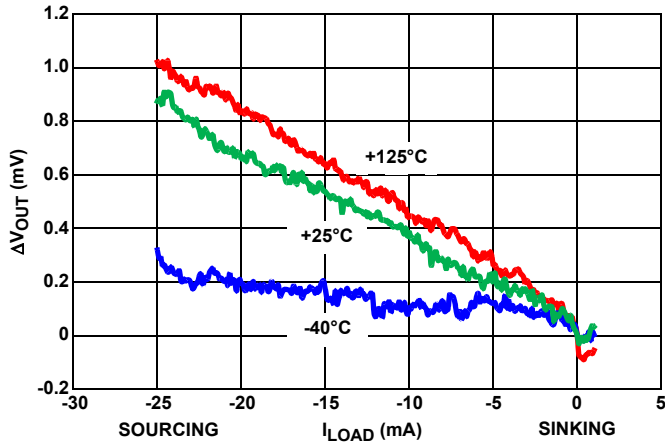

FIGURE 127. LOAD REGULATION OVER-TEMPERATURE

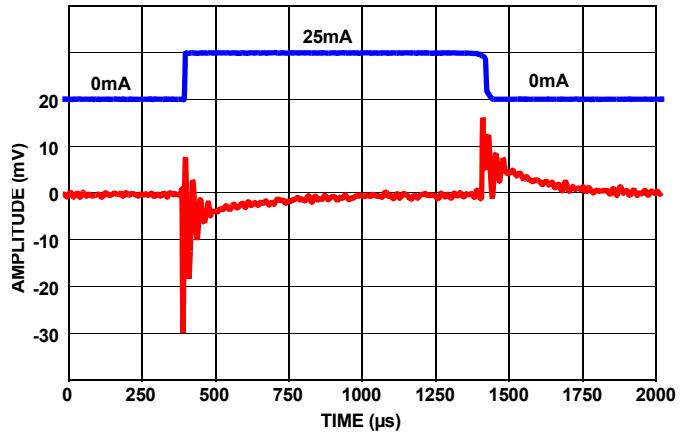

FIGURE 128. LOAD TRANSIENT RESPONSE AT 25mA LOAD AT 1μF

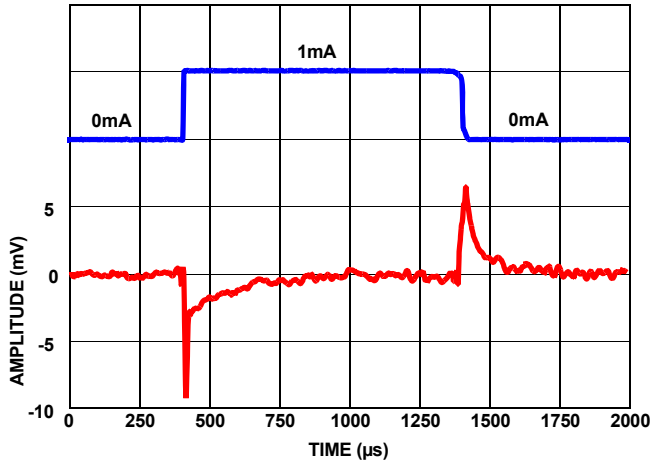

FIGURE 129. LOAD TRANSIENT RESPONSE AT 1mA LOAD AT 1μF

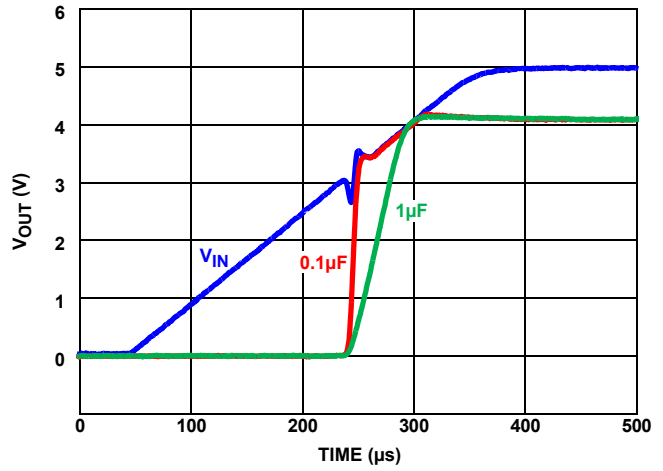

FIGURE 130. TURN-ON TIME

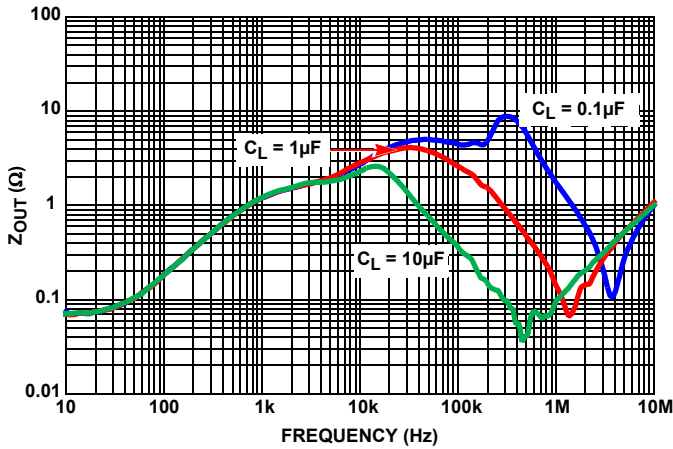

FIGURE 131.  $Z_{OUT}$  vs FREQUENCY

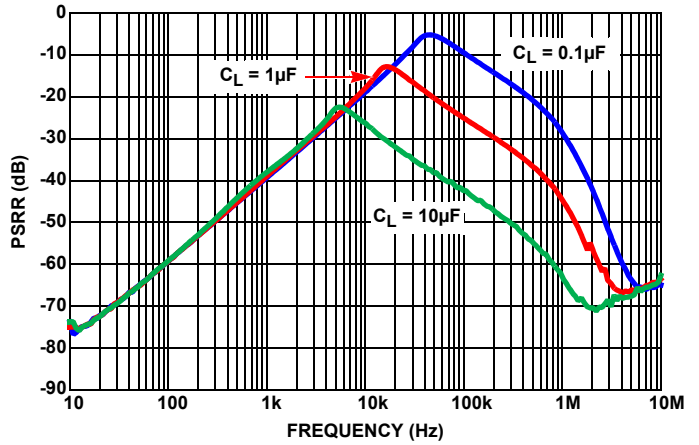

FIGURE 132. RIPPLE REJECTION AT DIFFERENT CAPACITIVE LOADS

## Typical Performance Characteristics Curves ( $V_{OUT} = 4.096V$ )

$V_{IN} = 3.0V$ ,  $I_{OUT} = 0mA$ ,  $T_A = +25^\circ C$  unless otherwise specified. (Continued)

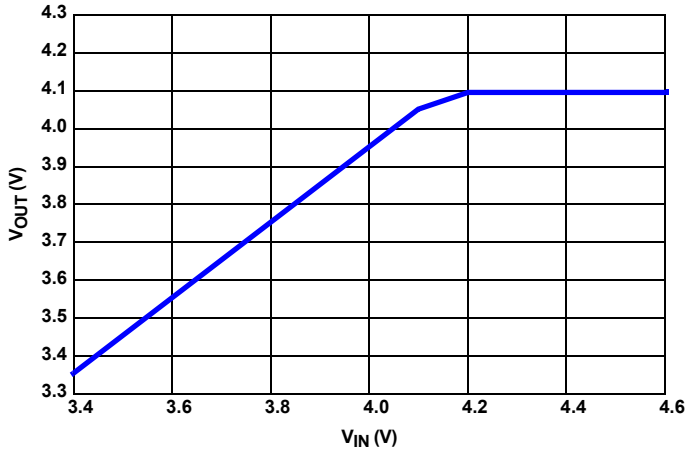

FIGURE 133. DROPOUT (10mA SOURCED LOAD)

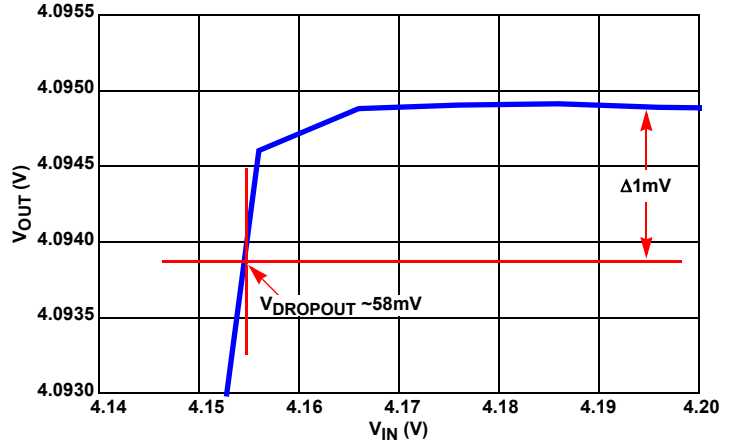

FIGURE 134. DROPOUT ZOOMED (10mA SOURCED LOAD)

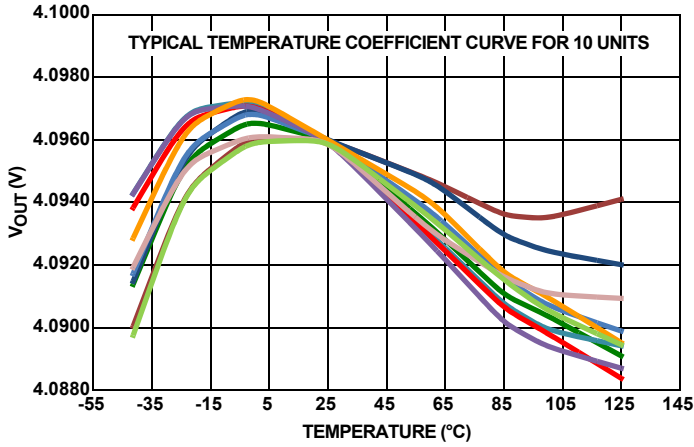

FIGURE 135.  $V_{OUT}$  vs TEMPERATURE

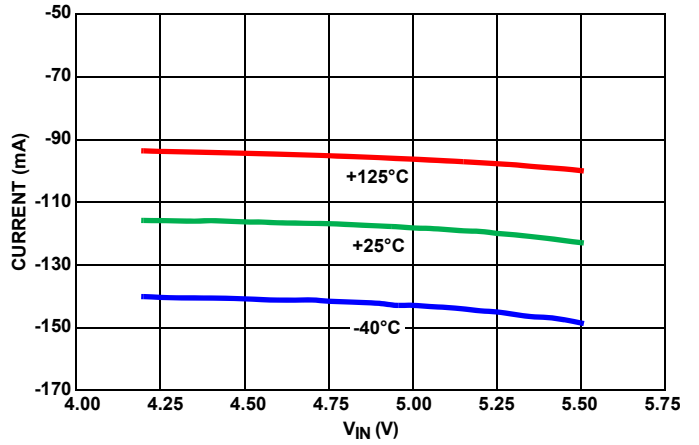

FIGURE 136. SHORT CIRCUIT TO GND

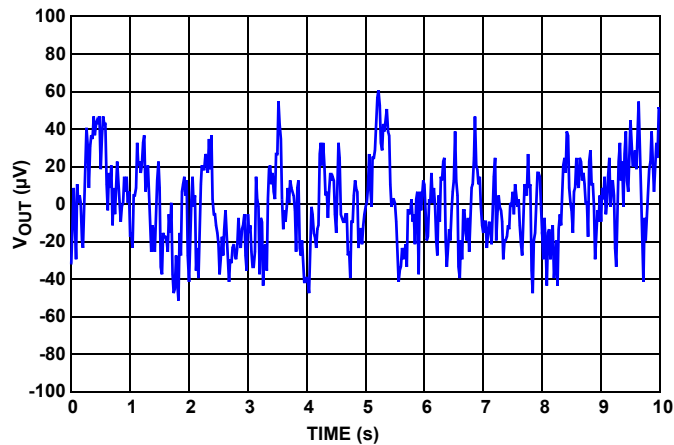

FIGURE 137.  $V_{OUT}$  vs NOISE, 0.1Hz TO 10Hz



## Applications Information

### Micropower Operation

The ISL21010 consumes very low supply current due to the proprietary bandgap technology. Low noise performance is achieved using optimized biasing techniques. Supply current is typically 48 $\mu$ A and noise in the 0.1Hz to 10Hz bandwidth is 58 $\mu$ V<sub>P-P</sub> to 100 $\mu$ V<sub>P-P</sub> ( $V_{OUT}$  = 2.048V, 3.0V and 3.3V) benefiting precision, low noise portable applications such as handheld meters and instruments.

Data Converters in particular can utilize the ISL21010 as an external voltage reference. Low power DAC and ADC circuits will realize maximum resolution with lowest noise. The device maintains output voltage during conversion cycles with fast response, although it is helpful to add an output capacitor, typically 1 $\mu$ F.

### Board Mounting Considerations

For applications requiring the highest accuracy, board mounting location should be reviewed. The device uses a plastic SOIC package, which will subject the die to mild stresses when the Printed Circuit (PC) board is heated and cooled, slightly changing the shape. Placing the device in areas subject to slight twisting can cause degradation of the accuracy of the reference voltage

due to these die stresses. It is normally best to place the device near the edge of a board, or the shortest side, as the axis of bending is most limited at that location. Mounting the device in a cutout also minimizes flex. Obviously mounting the device on flexprint or extremely thin PC material will likewise cause loss of reference accuracy.

### Board Assembly Considerations

Bandgap references provide high accuracy and low temperature drift but some PC board assembly precautions are necessary. Normal output voltage shifts of 100 $\mu$ V to 4mV can be expected with Pb-free reflow profiles or wave solder on multilayer FR4 PC boards. Precautions should be taken to avoid excessive heat or extended exposure to high reflow or wave solder temperatures, this may reduce device initial accuracy.

### Noise Performance and Reduction

The recommended capacitive load range for the ISL21010 is from 0.1 $\mu$ F to 10.0 $\mu$ F (0.22 $\mu$ F minimum required for 1.024V option) to ensure stability and best transient performance. Parallel 0.1 $\mu$ F (0.22 $\mu$ F for 1.024V) and 10 $\mu$ F capacitors can be used to optimize performance as well. The noise specification stated in the Electrical Specification tables (starting on [page 4](#)) is for 0.1 $\mu$ F (0.22 $\mu$ F for 1.024V option) capacitive load, and larger values will reduce the output noise level.

## Typical Application Circuit

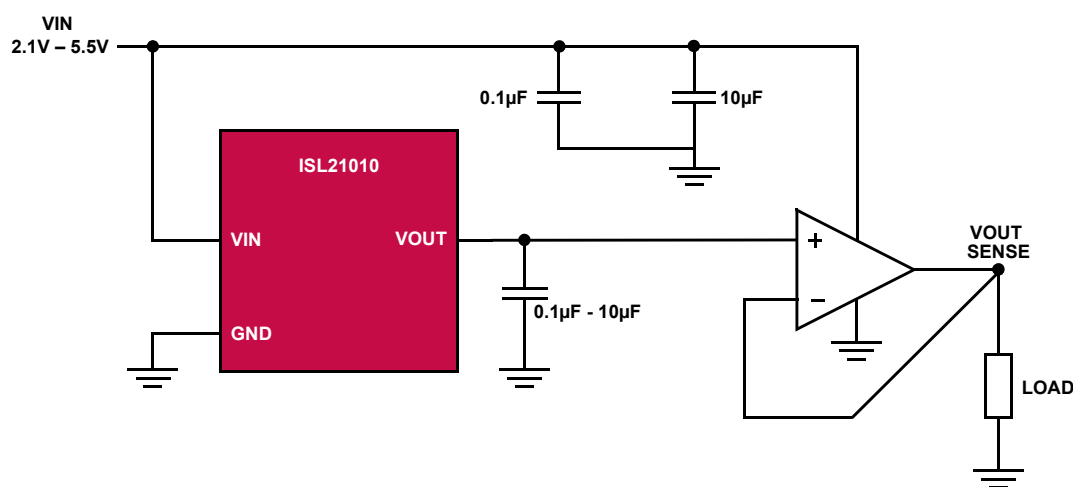

FIGURE 138. KELVIN SENSED LOAD

## Revision History

The revision history provided is for informational purposes only and is believed to be accurate, but not warranted. Please go to web to make sure you have the latest Rev.

DATE	REVISION	CHANGE
January 8, 2015	FN7896.3	<ul style="list-style-type: none"> <li>On page 1, in the Related Literature section added AN1853 and AN1883.</li> <li>On page 3, updated the ordering information table by adding the (-T7A) products.</li> <li>Changed the y-axis units on Figure 18, on page 11 from "(V)" to "(<math>\mu</math>V)".</li> </ul>
June 23, 2014	FN7896.2	<ul style="list-style-type: none"> <li>Added Curves for Voltage Refs 1.25V, 1.024V, 1.5V, 2.5V and 4.096V</li> <li>Updated POD with following changes: In Detail A, changed lead width dimension from 0.13+/-0.05 to 0.085-0.19 Changed dimension of foot of lead from 0.31+/-0.10 to 0.38+/-0.10 In Land Pattern, added 0.4 Rad Typ dimension In Side View, changed height of package from 0.91+/-0.03 to 0.95+/-0.07</li> </ul>
November 28, 2011	FN7896.1	<ul style="list-style-type: none"> <li>On page 1, Features: removed "Coming Soon" from ISL21010-10, -12, -15; ISL21010-25; and ISL21010-40 voltage options; combined -20 option with -10, -12, -15; changed -40 to -41</li> <li>On page 3, Ordering Information: added parts ISL21010DFH310Z-TK, ISL21010DFH312Z-TK, ISL21010CFH315Z-TK, ISL21010CFH325Z-TK, ISL21010CFH341Z-TK</li> <li>On page 4, Recommended Operating Conditions: added VOUT = 1.024V, 1.25V, 1.5V, 2.048V, 2.2V to 5.5V; VOUT = 2.5V.....2.6V to 5.5V; VOUT = 4.096V.....4.2V to 5.5V</li> <li>On page 4 through page 8, added Electrical Specifications tables for (ISL21010-10, VOUT = 1.024V), (ISL21010-12, VOUT = 1.25V), (ISL21010-15, VOUT = 1.5V), (ISL21010-41, VOUT = 4.096V)</li> <li>On page 6, Electrical Specifications (ISL21010-20, VOUT = 2.048V): changed VOUT/ TA, Thermal Hysteresis, TYP from 50 to 100</li> <li>On page 8, Note 10: changed "... where V<sub>OUT</sub> drops 1mV from V<sub>IN</sub> = 5.0V at T<sub>A</sub> = +25°C." to "... where V<sub>OUT</sub> drops 1mV from V<sub>IN</sub> = nominal at T<sub>A</sub> = +25°C."</li> <li>On page 25, Figure 94, changed title from "LOAD REGULATION OVER-TEMPERATURE" to "LOAD TRANSIENT RESPONSE AT 25mA LOAD". Figure 27, changed title from "LOAD TRANSIENT RESPONSE" to "LOAD TRANSIENT RESPONSE AT 1mA LOAD".</li> <li>On page 26, Figure 99, and page 29, Figure 116, changed figure titles to indicate 10mA instead of 1mA source load.</li> <li>On page 28, Figure 111, changed title from "LOAD REGULATION OVER-TEMPERATURE" to "LOAD TRANSIENT RESPONSE AT 25mA LOAD". Figure 112, changed title from "LOAD TRANSIENT RESPONSE" to "LOAD TRANSIENT RESPONSE AT 1mA LOAD"</li> <li>On page 33, under "Noise Performance and Reduction", added reference to capacitive load range for 1.024V option.</li> </ul>
August 9, 2011	FN7896.0	Initial Release

## About Intersil

Intersil Corporation is a leading provider of innovative power management and precision analog solutions. The company's products address some of the largest markets within the industrial and infrastructure, mobile computing and high-end consumer markets.

For the most updated datasheet, application notes, related documentation and related parts, please see the respective product information page found at [www.intersil.com](http://www.intersil.com).

You may report errors or suggestions for improving this datasheet by visiting [www.intersil.com/ask](http://www.intersil.com/ask).

Reliability reports are also available from our website at [www.intersil.com/support](http://www.intersil.com/support)

For additional products, see [www.intersil.com/en/products.html](http://www.intersil.com/en/products.html)

Intersil products are manufactured, assembled and tested utilizing ISO9001 quality systems as noted in the quality certifications found at [www.intersil.com/en/support/qualandreliaability.html](http://www.intersil.com/en/support/qualandreliaability.html)

*Intersil products are sold by description only. Intersil Corporation reserves the right to make changes in circuit design, software and/or specifications at any time without notice. Accordingly, the reader is cautioned to verify that data sheets are current before placing orders. Information furnished by Intersil is believed to be accurate and reliable. However, no responsibility is assumed by Intersil or its subsidiaries for its use; nor for any infringements of patents or other rights of third parties which may result from its use. No license is granted by implication or otherwise under any patent or patent rights of Intersil or its subsidiaries.*

For information regarding Intersil Corporation and its products, see [www.intersil.com](http://www.intersil.com)

## Package Outline Drawing P3.064

3 LEAD SMALL OUTLINE TRANSISTOR PLASTIC PACKAGE (SOT23-3)

Rev 3, 3/12

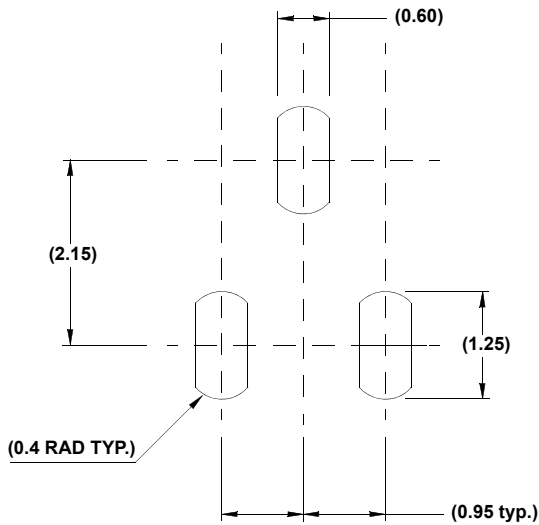
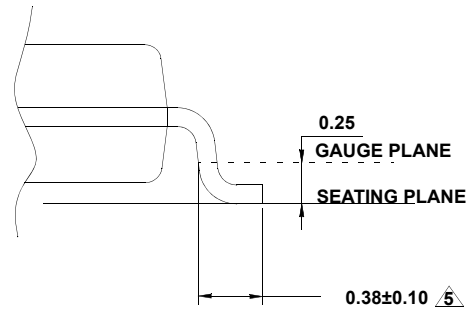
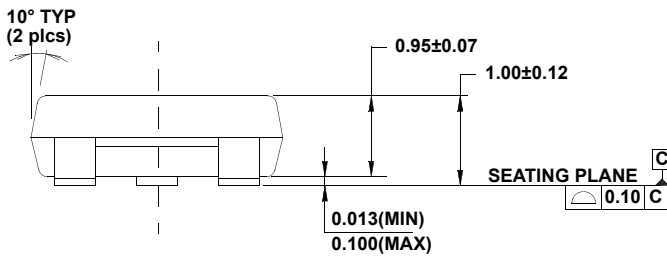
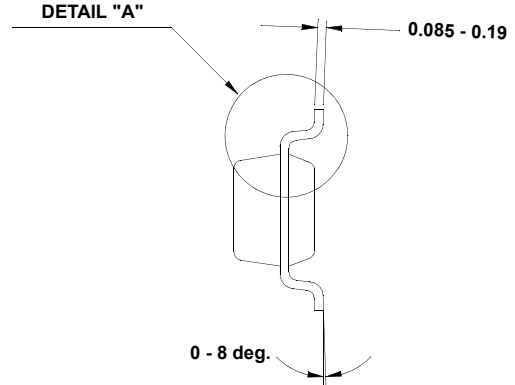
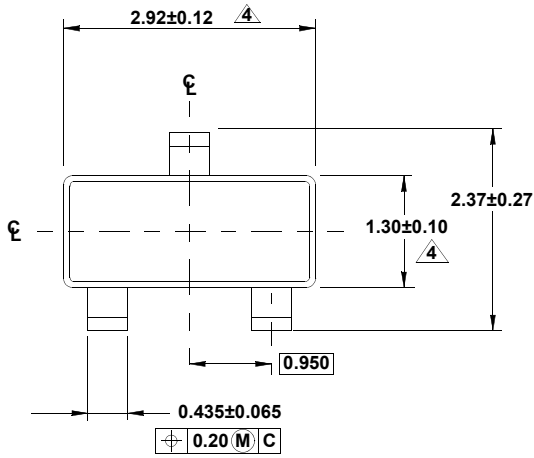

### NOTES:

1. Dimensions are in millimeters. Dimensions in ( ) for Reference Only.
2. Dimensioning and tolerancing conform to AMSEY14.5m-1994.
3. Reference JEDEC TO-236.
4. Dimension does not include interlead flash or protrusions. Interlead flash or protrusions shall not exceed 0.25mm per side.
5. Footlength is measured at reference to gauge plane.