



LIGITEK ELECTRONICS CO.,LTD.
Property of Ligitek Only

SRACE MOUNT LED TAPE AND REEL



Lead-Free Parts

LXZHIR9553

DATA SHEET

DOC. NO : QW0905-LXZHIR9553

REV. : A

DATE : 20 - Apr. - 2017



Features:

1. Top view white LED.
2. white SMT package.
3. Leadframe package with individual 4 pin.
4. Wide viewing angle.
5. Soldering methods: IR reflow soldering.
6. Feature of the device: more light due to higher optical efficiency; extremely wide viewing angle; ideal for backlighting and coupling in light guide.

Descriptions:

The LXZHIR9553 SMD has wide viewing angle and optimized light coupling by inter reflector, The low current requirement makes this device ideal for portable equipment or any other application where power is at a premium.

Applications:

1. Telecommunication: indicator and backlighting in telephone and fax.
2. Indicators.
3. Switch lights.

Device Selection Guide:

PART NO	MATERIAL	COLOR	
		Emitted	Lens
LXZHIR9553	AlGaInP	Red	Water Clear
	InGaN	Green	
	InGaN	Blue	

Package Dimensions

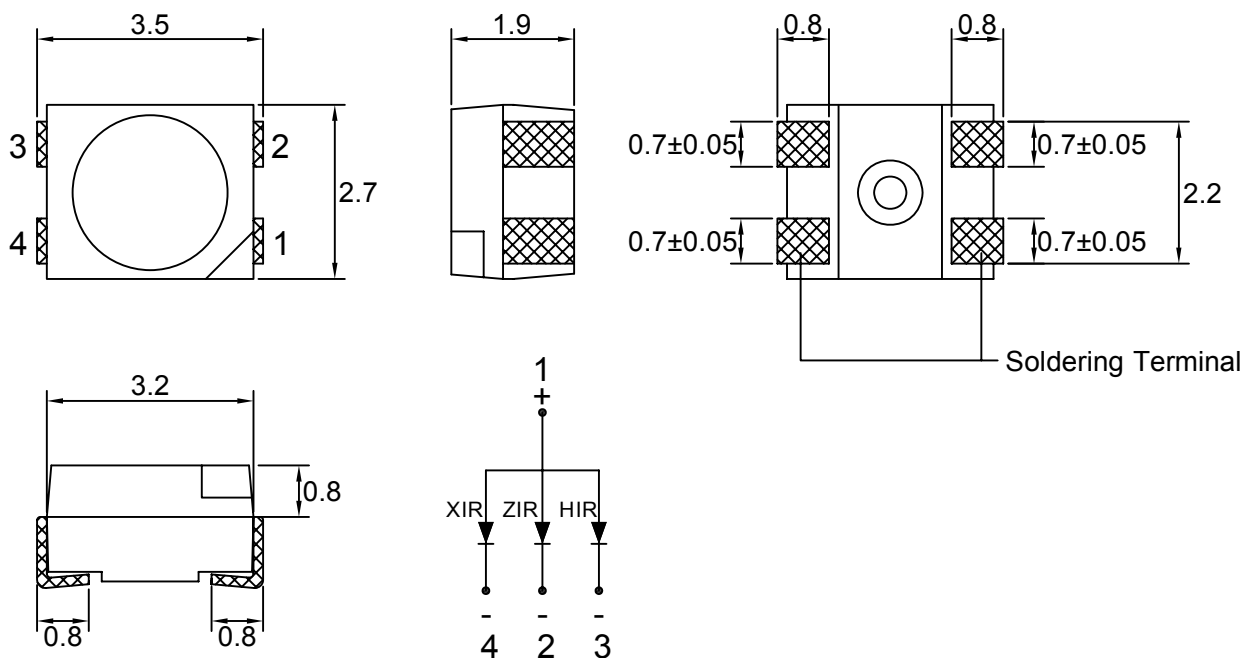

Note : 1.All dimension are in millimeter tolerance is $\pm 0.2\text{mm}$ unless otherwise noted.
2.Specifications are subject to change without notice.

Recommended Soldering Pad Dimensions

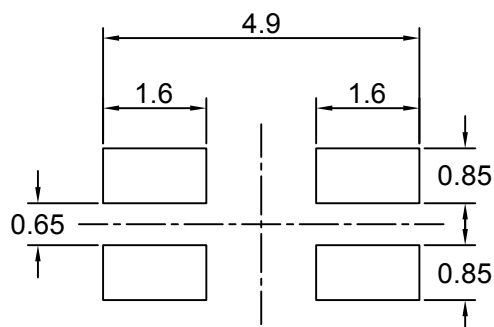

Note : The tolerances unless mentioned is $\pm 0.1\text{mm}$, Unit=mm.

Absolute Maximum Ratings at Ta=25°C

Parameter	Symbol	Ratings			UNIT
		XIR	ZIR	HIR	
Power Dissipation	PD	120	85	80	mW
Peak Forward Current (300pps, 10 μ s Pulse)	IFP	100	100	100	mA
Forward Current	IF	50	50	50	mA
Reverse Voltage	Vr	5	5	5	μ A
Operating Temperature	Topr	- 40 ~ + 85			°C
Storage Temperature	Tstg	- 40 ~ + 100			°C

Typical Electrical & Optical Characteristics (Ta=25°C)

Items	Symbol	Min.	Typ.	Max.	UNIT	CONDITION	
Radiant Intensity	Ie	X	1.1	2.0	----	mW/sr	IF=20mA
		Z	1.8	3.2	----		
		H	1.8	3.2	----		
Peak Emission Wavelength	λ_P	X	----	730	----	nm	IF=20mA
		Z	----	810	----		
		H	----	850	----		
Spectral Line Half-Width	$\Delta \lambda$	X	----	50	----	nm	IF=20mA
		Z	----	50	----		
		H	----	50	----		
Forward Voltage	VF	X	1.8	----	2.4	V	IF=20mA
		Z	1.2	----	1.7		
		H	1.2	----	1.6		
Viewing Angle	2 θ 1/2	X	----	120	----	deg	IF=20mA
		Z	----	120	----		
		H	----	120	----		

Note : 1.The forward voltage data did not including $\pm 0.1V$ testing tolerance.
 2.The luminous intensity data did not including $\pm 15\%$ testing tolerance.
 3.The color coordinates measurement allowance is ± 0.01 testing tolerance.

Luminous Intensity Classification

BIN CODE		I _e (mW/sr) at 20mA	
		Min.	Max.
X	K	1.1	1.4
	L	1.4	1.8
	M	1.8	2.4
	N	2.4	3.2

BIN CODE		I _e (mW/sr) at 20mA	
		Min.	Max.
Z	M	1.8	2.4
	N	2.4	3.2
	P	3.2	4.2
	Q	4.2	5.5

BIN CODE		I _e (mW/sr) at 20mA	
		Min.	Max.
H	M	1.8	2.4
	N	2.4	3.2
	P	3.2	4.2
	Q	4.2	5.5

Typical Electro-Optical Characteristics Curve
XIR CHIP

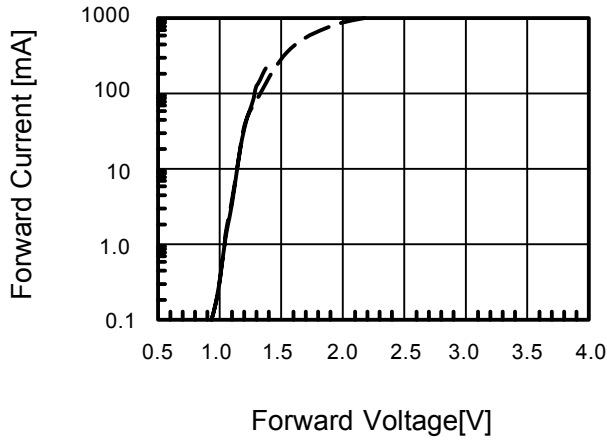

Fig.3. Relative Radiant Power vs. Forward Peak Current

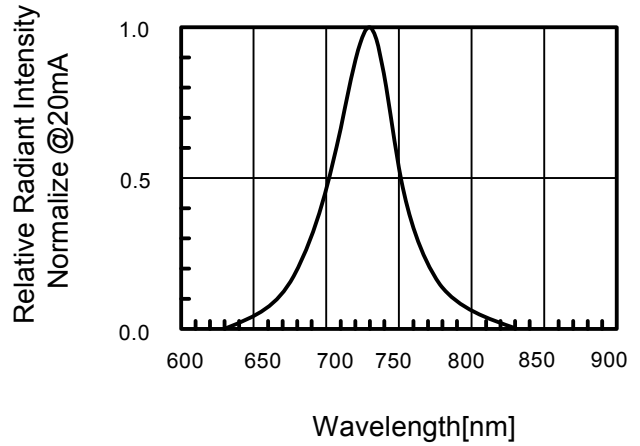

Fig.4 Relative Radiant Power vs. Forward Peak Current

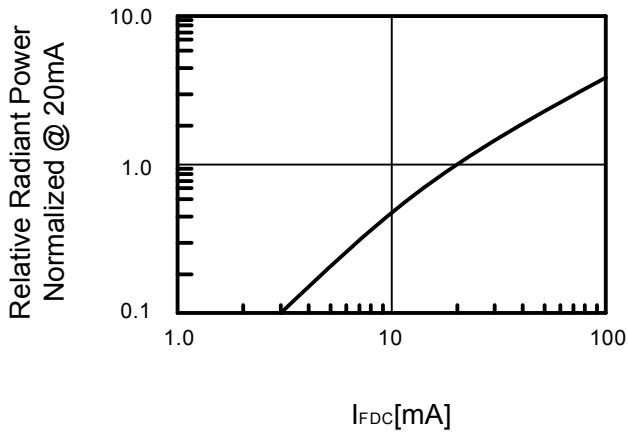

Fig.5 Forward DC Voltage vs. Temperature

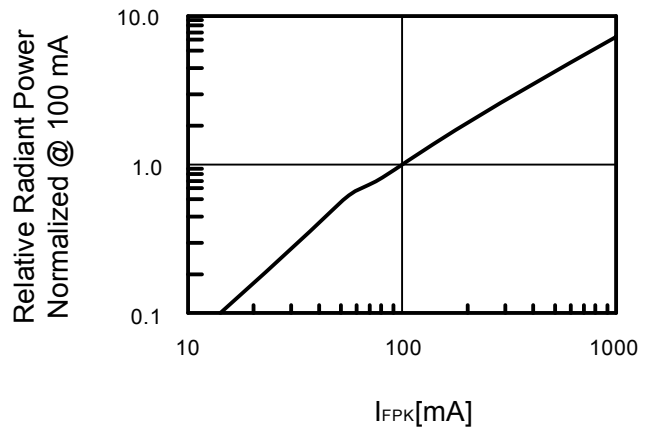
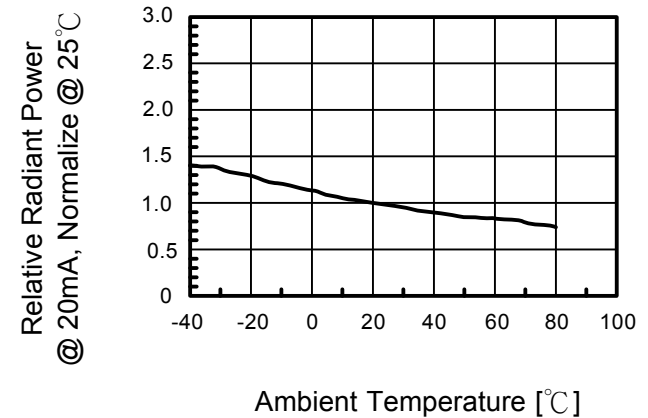
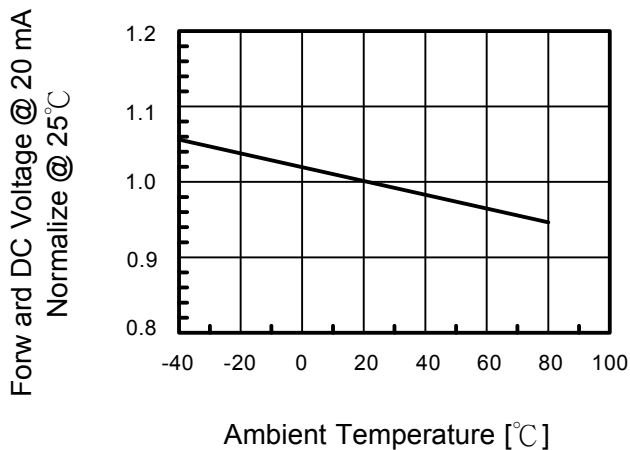

Fig.6 Relative Radiant Power vs. Temperature



Typical Electro-Optical Characteristics Curve ZIR CHIP

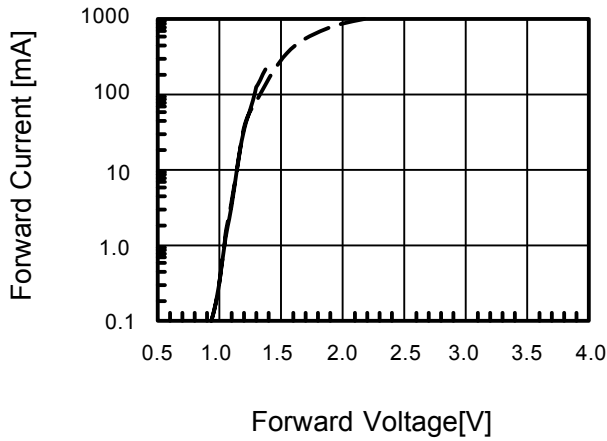

Fig.3. Relative Radiant Power vs. Forward Peak Current

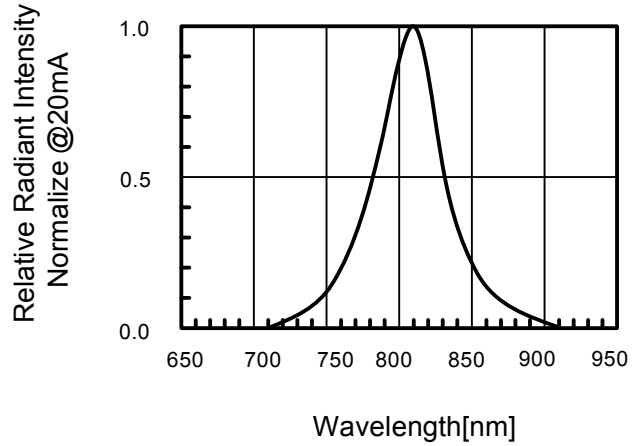

Fig.4 Relative Radiant Power vs. Forward Peak Current

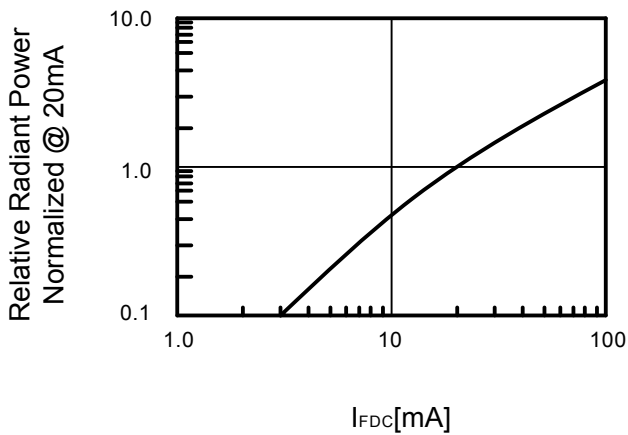

Fig.5 Forward DC Voltage vs. Temperature

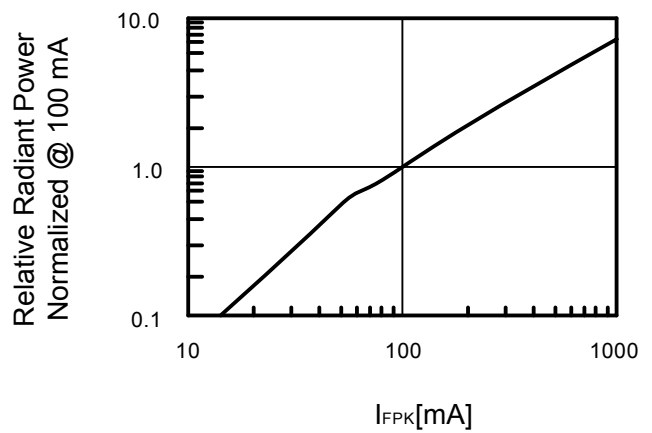
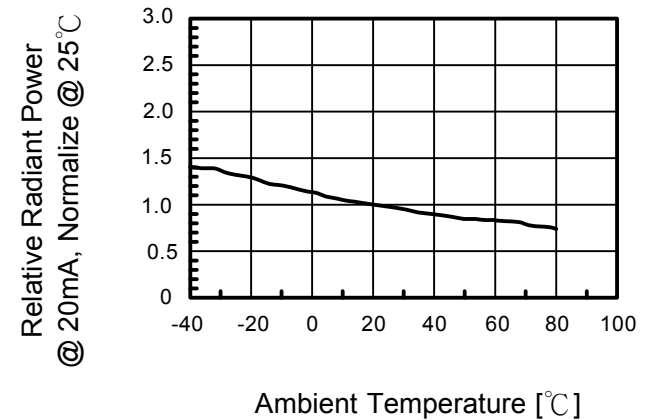
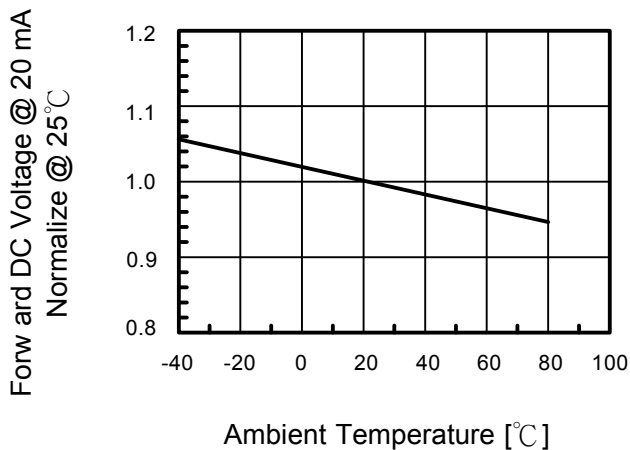

Fig.6 Relative Radiant Power vs. Temperature



Typical Electro-Optical Characteristics Curve

HIR CHIP

Fig.1 Forward Current vs. Forward Voltage

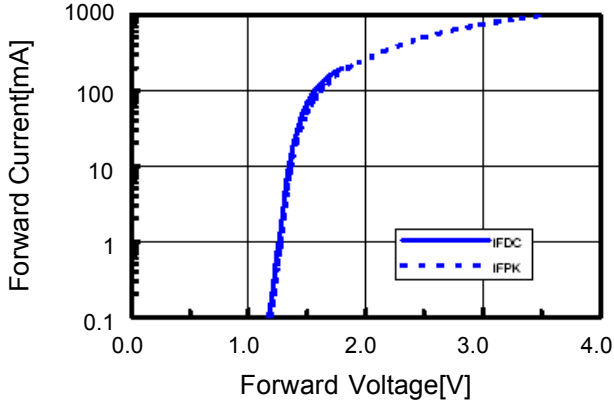

Fig.2 Relative Radiant Power vs. Wavelength

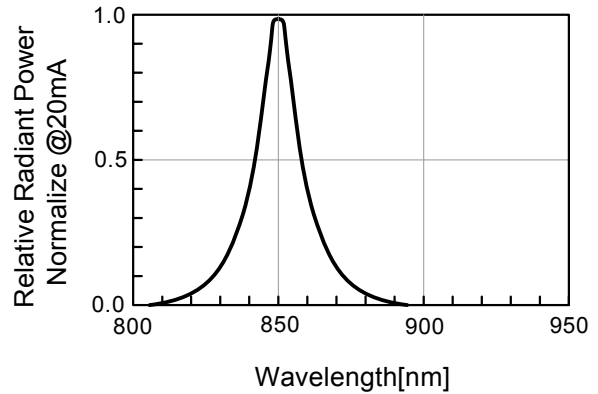

Fig.3 Relative Radiant Power vs. Forward DC Current

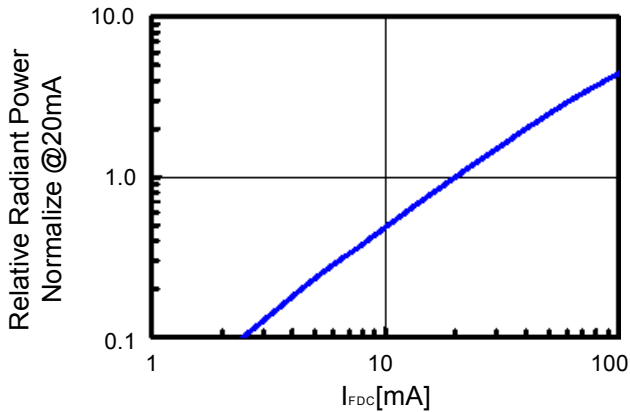

Fig.4 Relative Radiant Power vs. Forward Peak Current

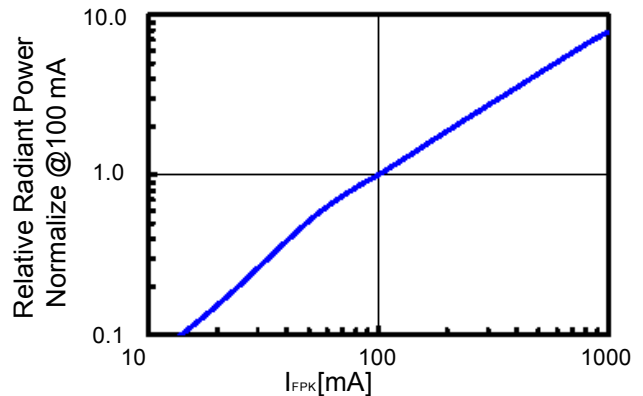

Fig.5 Forward DC Voltage vs. Temperature

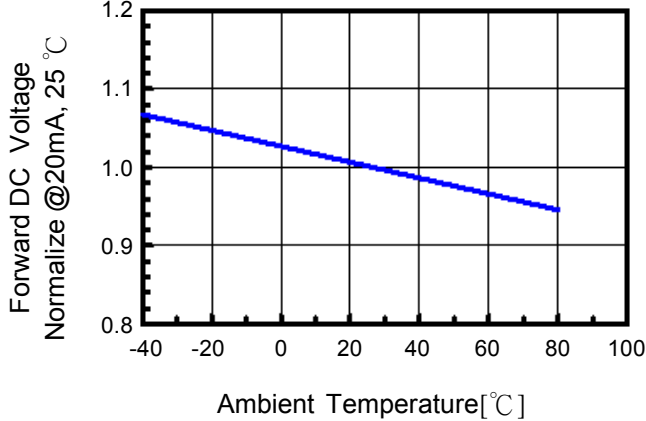
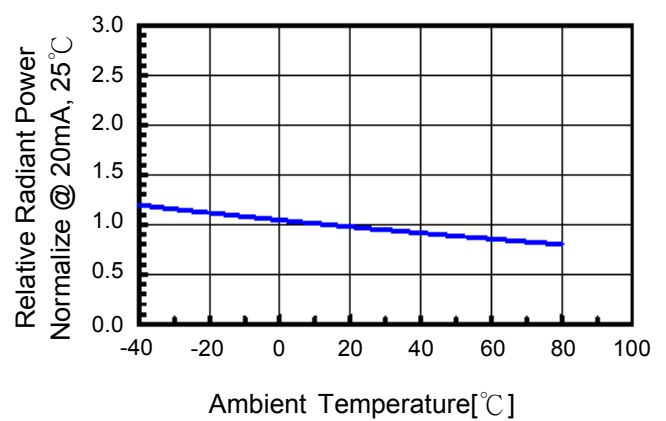
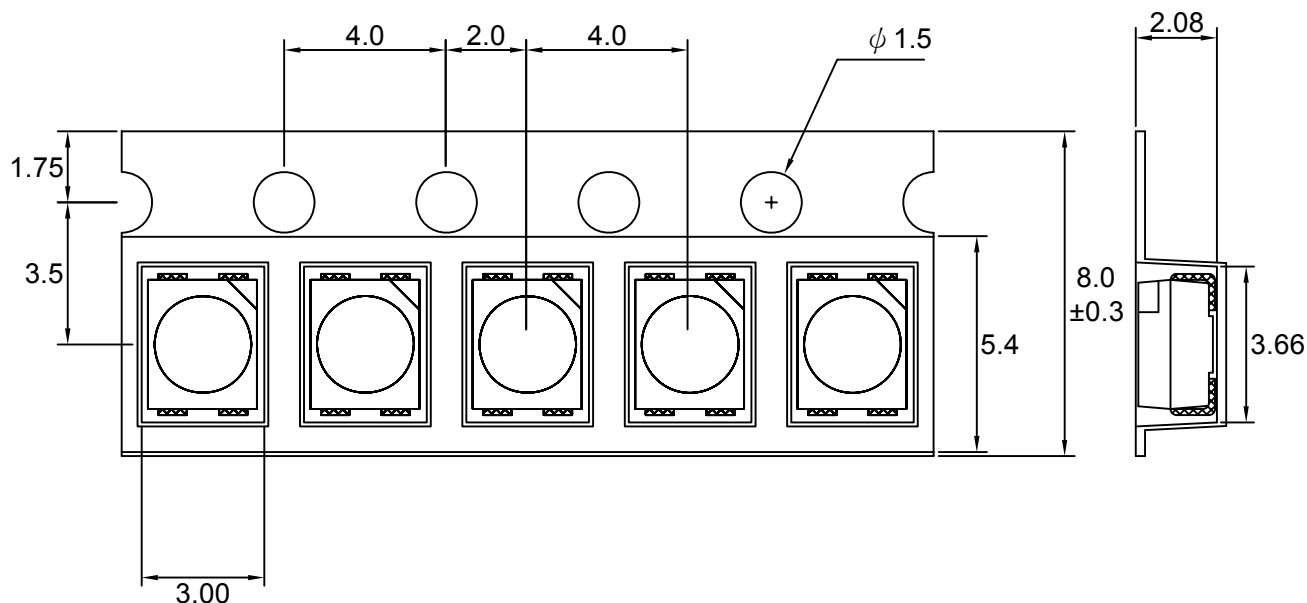

Fig.6 Relative Radiant Power vs. Temperature



Carrier Type Dimensions



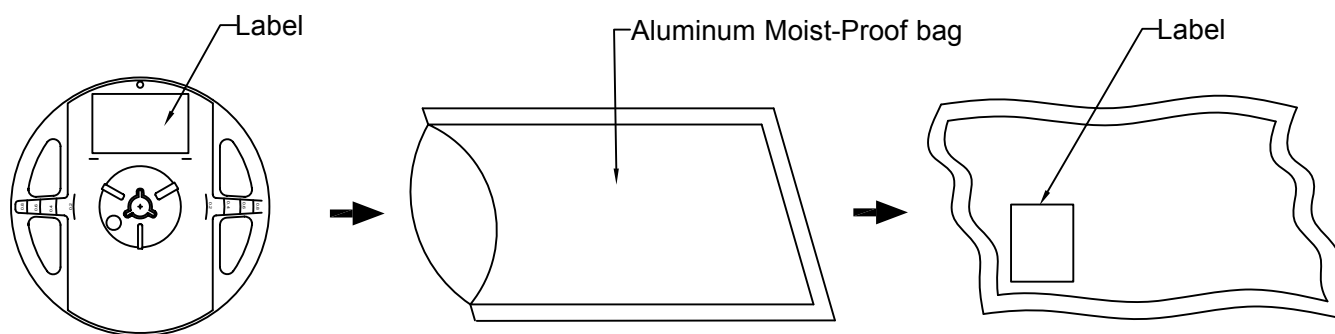

Note : The tolerances unless mentioned is ± 0.1 mm, Angle ± 0.5 . Unit=mm.

• Packing Specifications



Part No.	Description	Quantity/Reel
LXZHIR9553	12.0mm tape,7"reel	2000 PCS

Label Explanation

	LIGITEK ELECTRONICS CO., LTD.	
		
	PART :	LXZHIR9553
	LOT :	GS11370168
QTY(PCS):	2000	VF:1.2-1.7
BIN/HUE :	L-N-N	VF:1.2-1.6

BIN : Radiant Intensity

VF : Forward Voltage

Reel Dimensions

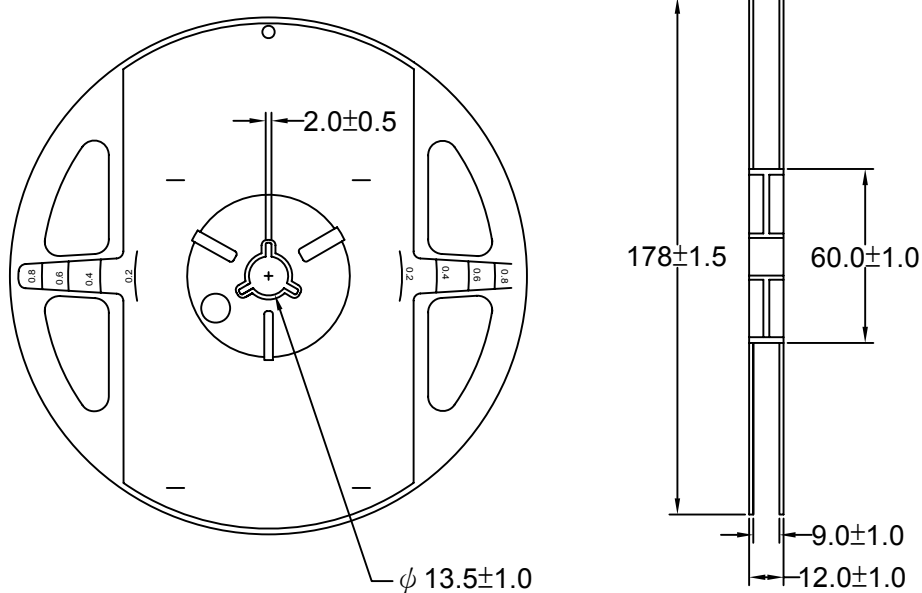

Box Explanation

1. 5 BAG / INNER BOX
2. INNER BOX SIZE : L X W X H 23cm X 8.5cm x 26cm

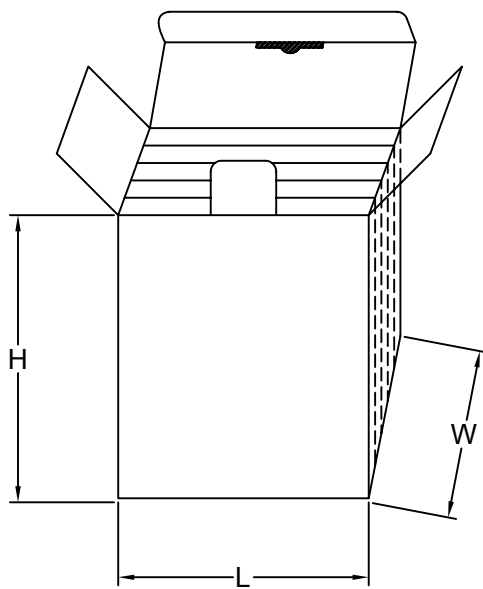

3. 10 INNER BOXES / CARTON
4. CARTON SIZE : L X W X H 58cm X 34cm x 35cm

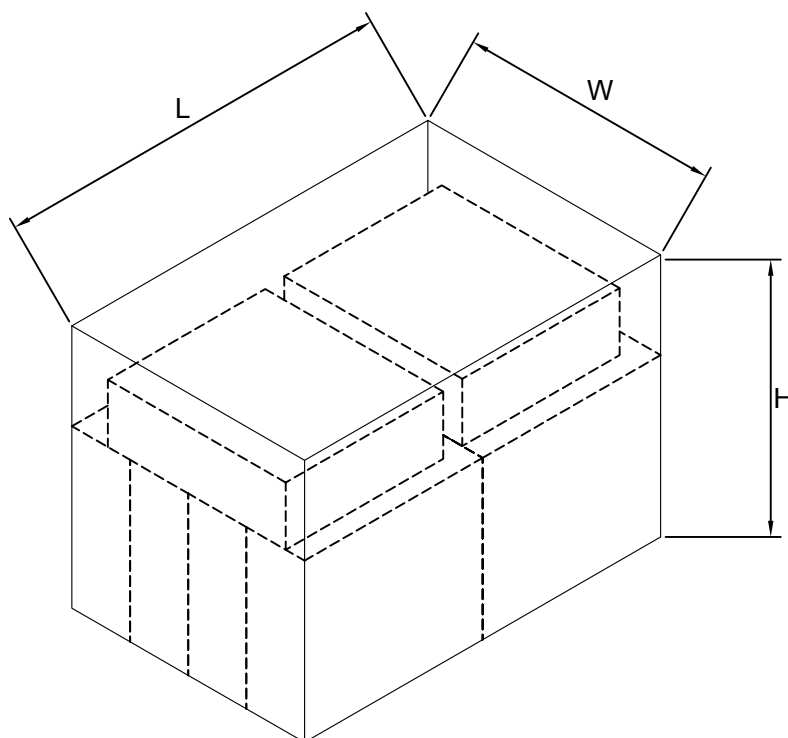

Recommended Soldering Conditions**1. Hand Solder**

Basic spec is $\leq 320^{\circ}\text{C}$ 3 sec one time only.

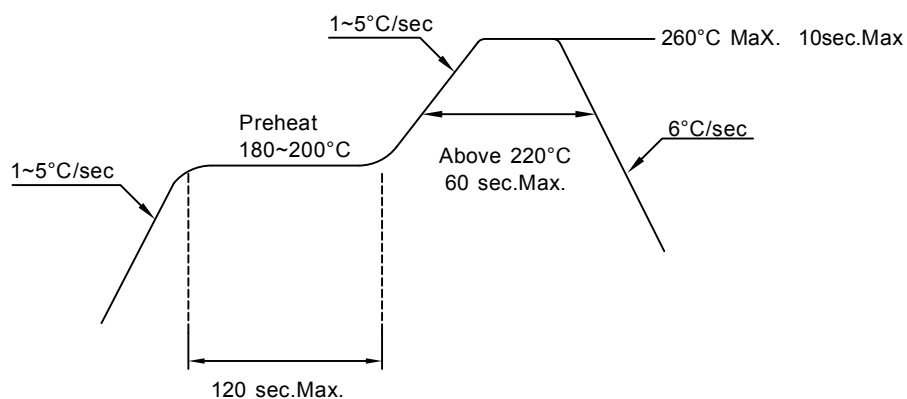
2. PB-Free Reflow Solder**Note:**

- 1.Reflow soldering should not be done more than two times.
- 2.Wave Solder should not be done more than one times.
- 3.When soldering,do not put stress on the LEDs during heating.
- 4.After soldering,do not warp the circuit board.

Precautions For Use:**Storage time:**

1. Calculated shelf life before opening is 12 months at $< 30^{\circ}\text{C}$ and $< 90\%$ relative humidity (RH)
2. After bag is opened, devices which will be subjected to reflow soldering or other high temperature processes must be
 - a) Assembled within 168 hours in an environment of $\leq 30^{\circ}\text{C} / 60\%$ RH, or
 - b) Stored at ambient of 10% RH or less
3. Devices are required baking before assembly if:
 - a) Humidity Indicator Card reads $>10\%$ (for level 2a -5a) or $>60\%$ (for level 2) at ambient temperature $23\pm 5^{\circ}\text{C}$
 - b) 2.a) or 2.b) doesn't meet
4. If baking is required, devices should be baked for >72 hours at $60\pm 5^{\circ}\text{C} / 5\%$ RH. Performing baking only once, and using the baked devices within 72 hours.

Drive Method:

LED is a current operated device, and therefore, requires some kind of current limiting incorporated into the driver circuit. This current limiting typically takes the form of a current limiting resistor placed in series with the LED.

Consider worst case voltage variations than could occur across the current limiting resistor. The forward current should not be allowed to change by more than 40% of its desired value.

Circuit model A

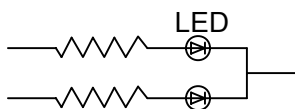

Circuit model B

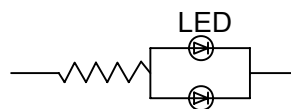

(A) Recommended circuit.

(B) The difference of brightness between LED could be found due to the VF-IF characteristics of LED.

Cleaning:

Use alcohol-based cleaning solvents such as isopropyl alcohol to clean the LED.

ESD(Electrostatic Discharge):

Static Electricity or power surge will damage the LED. Use of a conductive wrist band or anti-electrostatic glove is recommended when handling these LED. All devices, equipment and machinery must be properly grounded.

Reliability Test:

Classification	Test Item	Test Condition	Sample Size
Endurance Test	Operating Life Test	1.Ta=25°C 2.If=20mA 3.t=1000 hrs (-24hrs,+72hrs)	22
	High Temperature Storage Test	1.Ta=100°C±5°C 2.t=1000 hrs (-24hrs,+72hrs)	22
	Low Temperature Storage Test	1.Ta=-40°C±5°C 2.t=1000 hrs (-24hrs,+72hrs)	22
	High Temperature High Humidity Storage Test	1.Ta=85°C 2.RH=85% 3.t=1000hrs(-24hrs,+72hrs)	22
Environmental Test	Thermal Shock Test	1.Ta=100°C±5°C ~ -40°C±5°C 20min/ 10sec / 20min 2.total 100 cycles	22
	Temperature Cycling	1.100°C±5°C ~ -40°C±5°C 30mins / 5mins / 30mins 2.100 Cyeles	22
	IR Reflow	1.T=260°C Max. 10sec.Max. 2. 6 Min	22