

STRADA-SQ-FS2

Beam for symmetrical tunnel lighting and parking garages. Ideal for catenary street lighting. Version with location pins. Assembly with installation tape.

TECHNICAL SPECIFICATIONS:

Dimensions	25x25 mm
Height	8.2 mm
Fastening	tape, pin
Colour	clear
Box size	480 x 280 x 300 mm
Box weight	7.3 kg
Quantity in Box	1568 pcs
ROHS compliant	yes ⓘ



MATERIAL SPECIFICATIONS:

Component	Type	Material	Colour
STRADA-SQ-FS2	Lens	PMMA	clear
ROSE-TAPE	Tape	PU tape	black

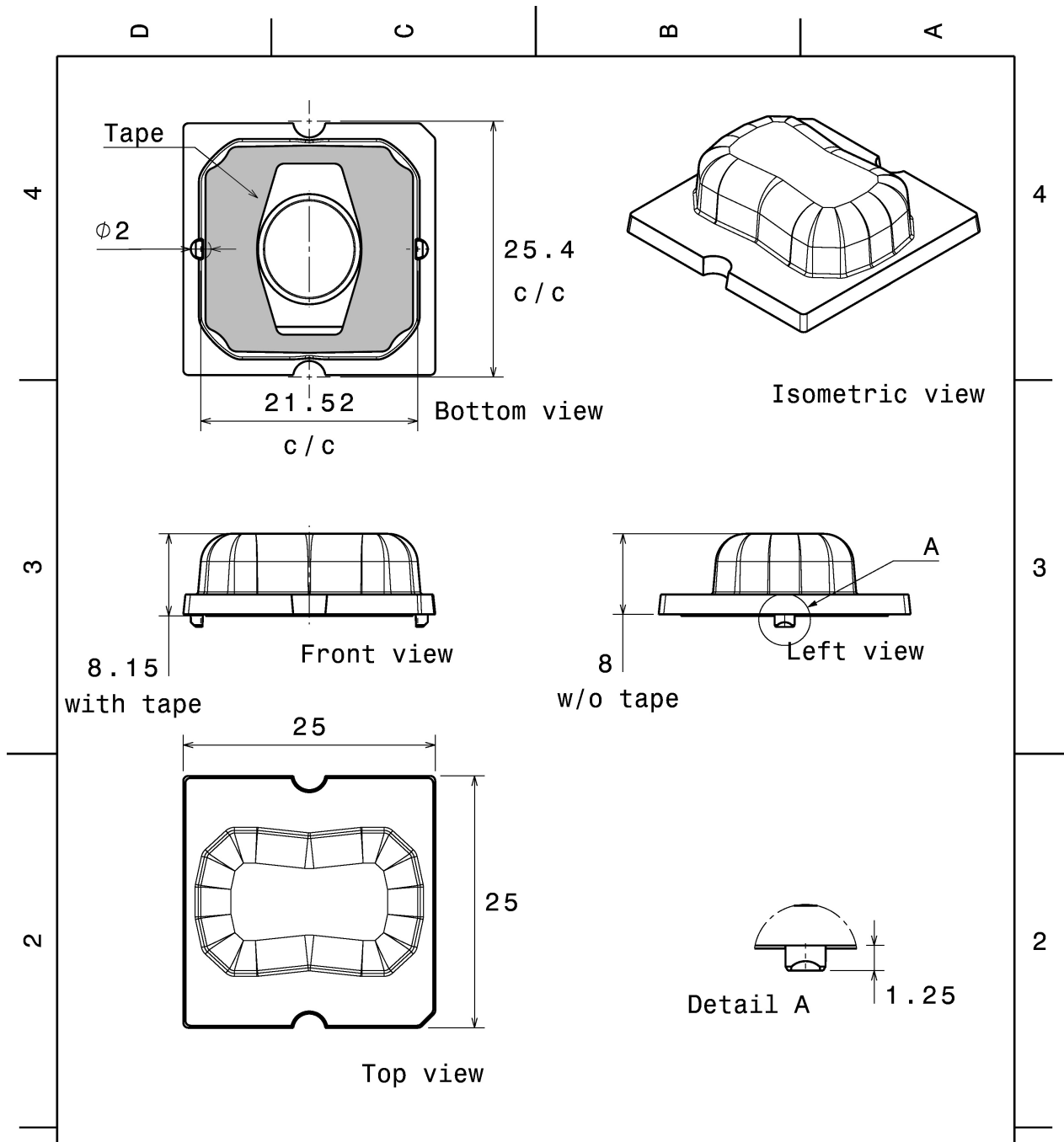

Tolerances if not otherwise shown
According to DIN ISO 2768-1
Linear measures:
Up to 30mm class M, otherwise class C.
According to DIN ISO 2768-2
Form and position: class L

LEDiL Ledil Oy
Salorankatu 10
FIN 24240 SALO
Finland

THIRD ANGLE PROJECTION:

DRAWING TITLE
Datasheet STRADA-SQ-FS2

This drawing is the property of LEDiL Oy. It may not be reproduced, copied or communicated without a written agreement with LEDiL Oy.

SIZE	PART NUMBER
A4	-

SCALE	2:1	WEIGHT	-	SHEET	1/1
-------	-----	--------	---	-------	-----

PHOTOMETRIC DATA (MEASURED):

CITIZEN

LED PSL440
 FWHM Asymmetric
 Efficiency 91 %
 Peak intensity 0.660 cd/lm
 Required components:

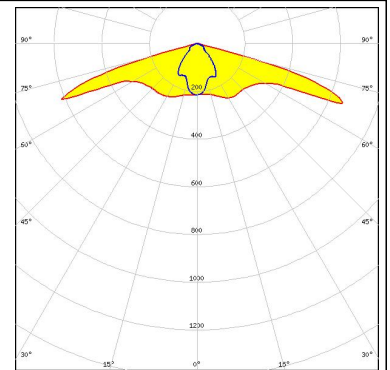

CITIZEN

LED PSL445
 FWHM Asymmetric
 Efficiency 91 %
 Peak intensity 0.450 cd/lm
 Required components:

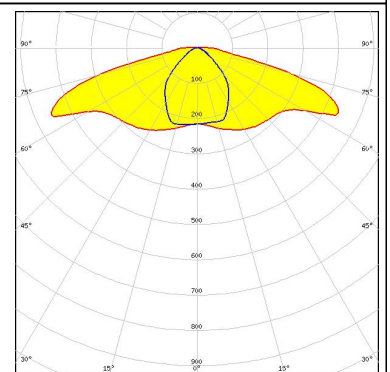

CREE

LED MK-R
 FWHM Asymmetric
 Efficiency 81 %
 Peak intensity 0.425 cd/lm
 Required components:

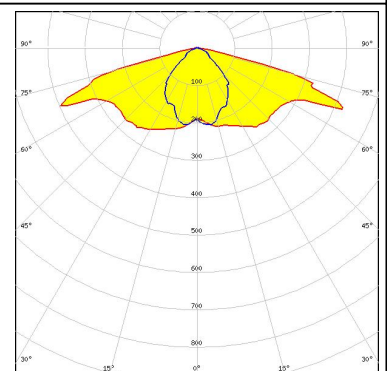

CREE

LED XHP70
 FWHM Asymmetric
 Efficiency 78 %
 Peak intensity 0.420 cd/lm
 Required components:

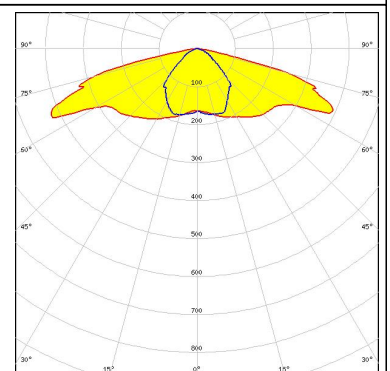

Undefined Manufacturer: Protective Plate, Glass

PHOTOMETRIC DATA (MEASURED):

LUMILEDS

LED LUXEON M/MX
FWHM Asymmetric
Efficiency 81 %
Peak intensity 0.440 cd/lm
Required components:
Undefined Manufacturer: Protective Plate, Glass

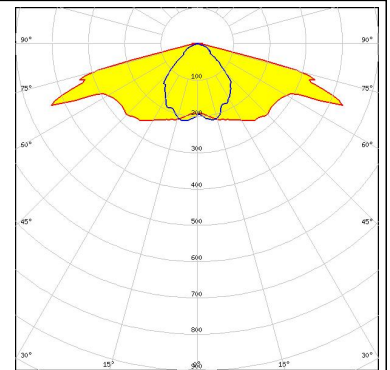

LUMILEDS

LED LUXEON XR-M linear 1x3, 1x4, 1x5
FWHM Asymmetric
Efficiency 92 %
Peak intensity 0.550 cd/lm
Required components:

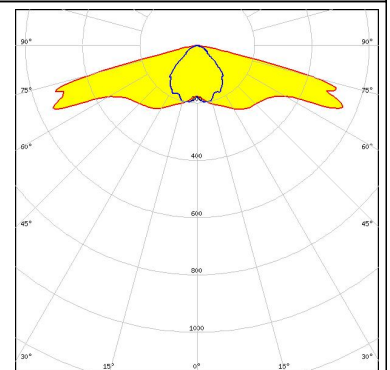

OSRAM

Opto Semiconductors
LED Duris S10
FWHM Asymmetric
Efficiency 88 %
Peak intensity 0.570 cd/lm
Required components:

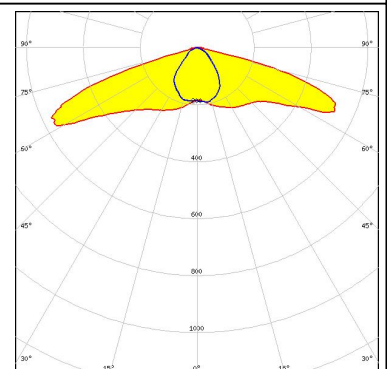

PHOTOMETRIC DATA (SIMULATED):



LED MHB-A/B
FWHM Asymmetric
Efficiency 89 %
Peak intensity 0.500 cd/lm
Required components:

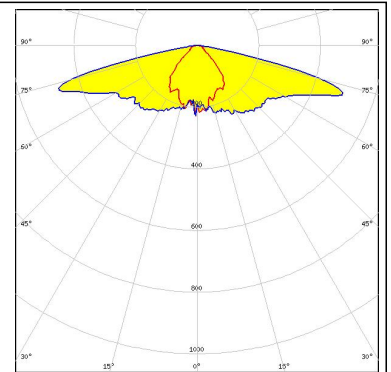

LED OSCONIQ P 7070
FWHM Asymmetric
Efficiency 88 %
Peak intensity 0.630 cd/lm
Required components:

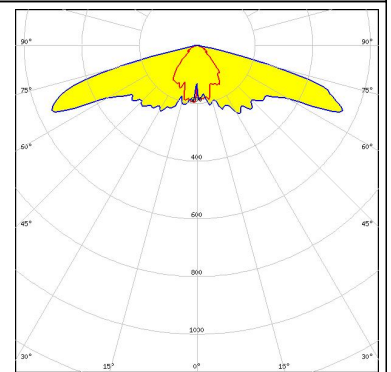

GENERAL INFORMATION:

NOTE: The typical beam angle will be changed by different color, chip size and chip position tolerance. The typical total beam angle is the full angle measured where the luminous intensity is half of the peak value.

MATERIALS:

As part of our continuous research and improvement processes, and to ensure the best possible quality and availability of our products, LEDiL reserves the right to change material grades without notice.

PRODUCT DATA USER AGREEMENT AND DISCLAIMER:

The measured data in the provided downloadable LEDiL Product Datasheets and Mechanical 2D-Drawings is rounded and provided as reference for planning. LEDiL Oy's optical specifications have been verified by conducting performance testing of the products in accordance with the company's quality system. The reported data are averaged results of multiple measurements with typical variation. LEDiL Oy reserves the right to without prior notification make changes and improvements to its products.

LEDiL Oy assumes neither warranty, nor guarantee nor any other liability of any kind for the contents and correctness of the provided data. The provided data has been generated with highest diligence but the provided data may in reality not represent the complete possible variation range of all intrinsic parameters. Therefore, in certain cases a deviation from the provided data could occur.

LEDiL Oy reserves the right to undertake technical changes of its products without further notification which could lead to changes in the provided data. LEDiL Oy assumes no liability of any kind for the possible deviation from any provided data or any other damage resulting from the usage of the provided data.

The user agrees to this disclaimer and user agreement with the download or usage of the provided files.

LEDiL Oy

Joensuunkatu 13
FI-24240 SALO
Finland

LEDiL Inc.

228 West Page Street
Suite D
Sycamore IL 60178
USA

Local sales and technical support

[www.ledil.com/
where_to_buy](http://www.ledil.com/where_to_buy)

Shipping locations

Salo, Finland
Hong Kong, China

Distribution Partners

[www.ledil.com/
where_to_buy](http://www.ledil.com/where_to_buy)