

# SMD Power Inductor CDRH8D43R/T125



Halogen Free



## Description

- Ferrite drum core construction.
- Magnetically shielded.
- L × W × H: 8.5 × 8.3 × 4.5 mm Max.
- Product weight: 1.0g(Ref.)
- Moisture Sensitivity Level: 1
- RoHS compliance.
- Halogen Free available.

## Environmental Data

- Operating temperature range: -40°C ~ +125°C (including coil's self temperature rise)
- Storage temperature range: -40°C ~ +125°C
- Solder reflow temperature: 260 °C peak.

## Packaging

- Carrier tape and reel packaging
- 13.0" diameter reel
- 500pcs per reel

## Applications

- Automotive and other high temperature, high reliability application.

## Dimension - [mm]

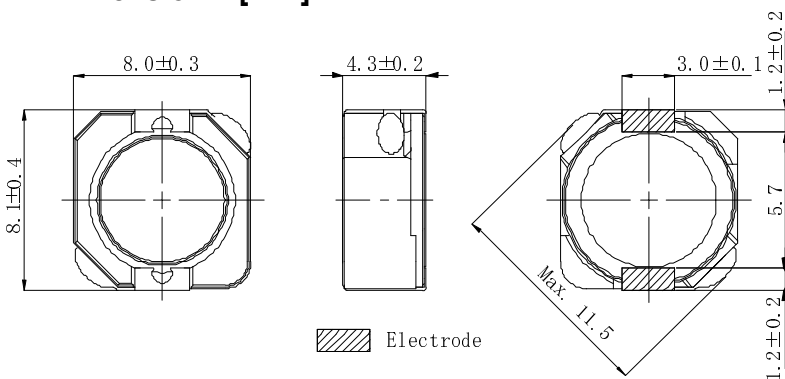

## Land pattern and Schematics - [mm]

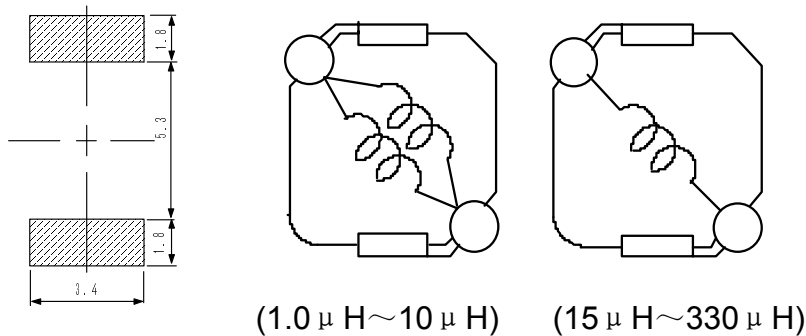

# SMD Power Inductor

## CDRH8D43R/T125



### Electrical Characteristics

Part No.	Stamp	Inductance ( $\mu$ H) [Within] ※1	D.C.R. (m $\Omega$ ) [Max.] (at 20°C) ※2	Saturation current (A) ※3		Temperature rise current (A) ※4
				(at 20°C)	(at 125°C) (Typ.)	
CDRH8D43RT125NP-1R0NC	1R0	1.0 $\pm$ 30%	9.7(7.8)	8.00	6.00	7.50
CDRH8D43RT125NP-1R8NC	1R8	1.8 $\pm$ 30%	12.1(9.7)	7.30	5.80	6.40
CDRH8D43RT125NP-2R4NC	2R4	2.4 $\pm$ 30%	14.0(11.2)	7.10	5.60	5.80
CDRH8D43RT125NP-3R3NC	3R3	3.3 $\pm$ 30%	16.3(13.0)	6.10	4.70	5.20
CDRH8D43RT125NP-4R3NC	4R3	4.3 $\pm$ 30%	23.5(18.8)	5.40	4.20	4.30
CDRH8D43RT125NP-5R6NC	5R6	5.6 $\pm$ 30%	26.9(21.5)	4.50	3.50	3.70
CDRH8D43RT125NP-6R8NC	6R8	6.8 $\pm$ 30%	29.8(23.9)	4.20	3.30	3.45
CDRH8D43RT125NP-8R2NC	8R2	8.2 $\pm$ 30%	40.8(32.6)	4.00	3.20	2.85
CDRH8D43RT125NP-100MC	100	10 $\pm$ 20%	45.0(36.0)	3.50	2.75	2.70
CDRH8D43RT125NP-150MC	150	15 $\pm$ 20%	61.8(49.4)	2.90	2.30	2.30
CDRH8D43RT125NP-220MC	220	22 $\pm$ 20%	77.6(62.0)	2.35	1.85	2.05
CDRH8D43RT125NP-330MC	330	33 $\pm$ 20%	123(98.5)	1.95	1.55	1.55
CDRH8D43RT125NP-470MC	470	47 $\pm$ 20%	186(149)	1.60	1.30	1.30
CDRH8D43RT125NP-680MC	680	68 $\pm$ 20%	288(231)	1.30	1.05	1.03
CDRH8D43RT125NP-101MC	101	100 $\pm$ 20%	353(282)	1.10	0.87	0.93
CDRH8D43RT125NP-151MC	151	150 $\pm$ 20%	575(460)	0.91	0.72	0.76
CDRH8D43RT125NP-221MC	221	220 $\pm$ 20%	861(689)	0.75	0.60	0.60
CDRH8D43RT125NP-331MC	331	330 $\pm$ 20%	1330(1068)	0.62	0.50	0.48

※ 1 Measuring frequency inductance at 100kHz.

※ 2 ( ) are typical value.

※ 3 Saturation current: The value of D.C. current when the inductance decreases to 65% of its nominal value.

※ 4 Temperature rise current: The value of D.C. current when the temperature rise is  $\Delta t=40^{\circ}\text{C}$  ( $T_a=20^{\circ}\text{C}$ ).

# SMD Power Inductor CDRH8D43R/T125



## Saturation Current & Temperature Rise Graph

— L (20°C) — L (125°C) —  $\Delta T$

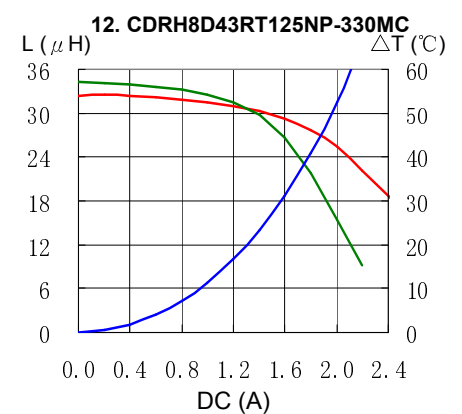
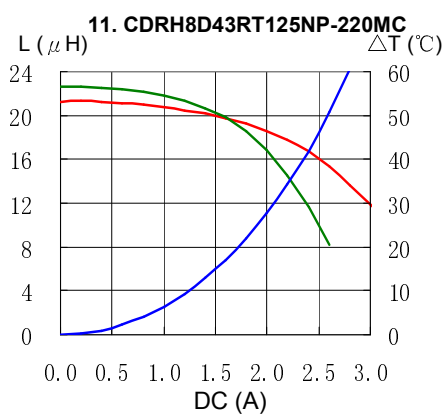
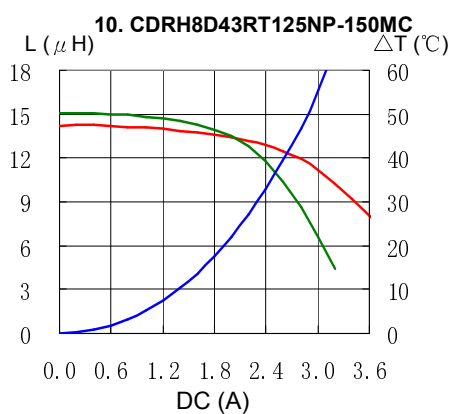
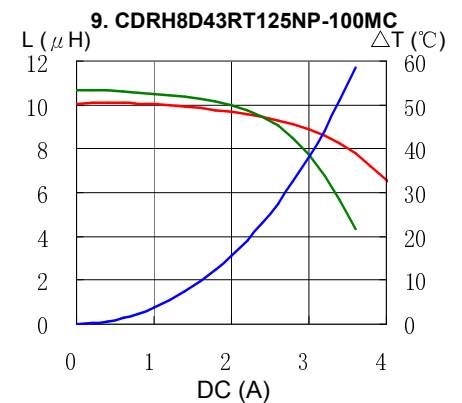
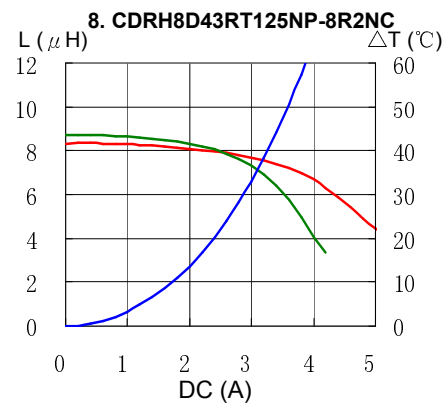
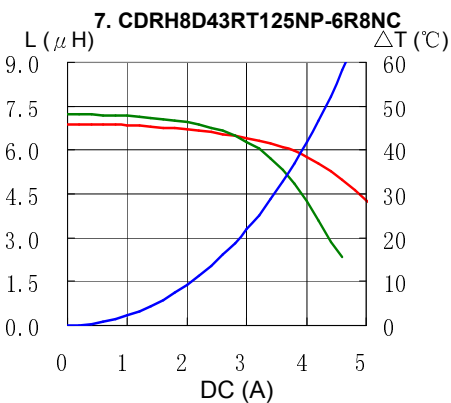
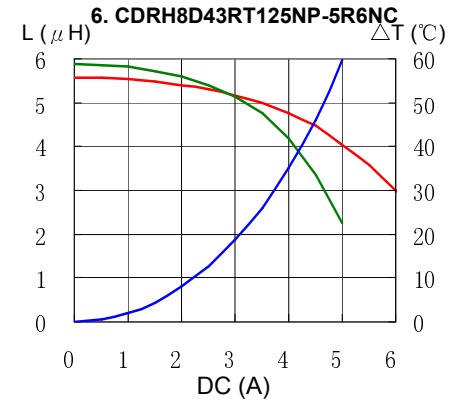
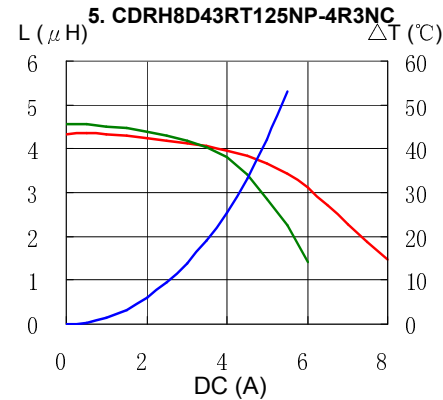
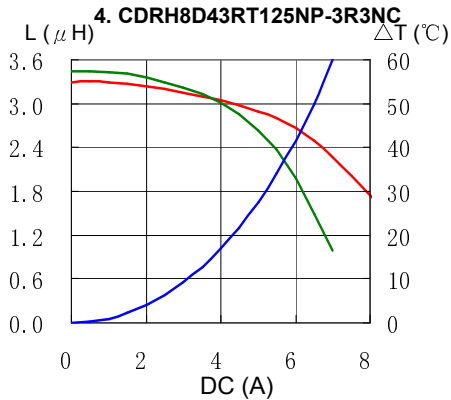
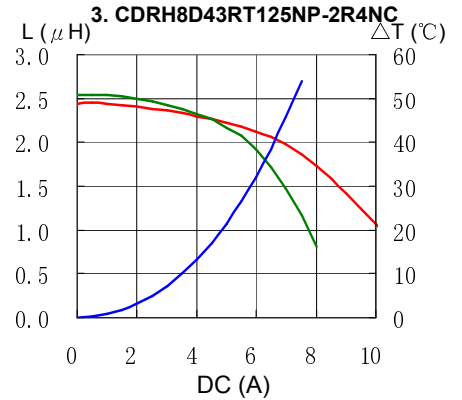
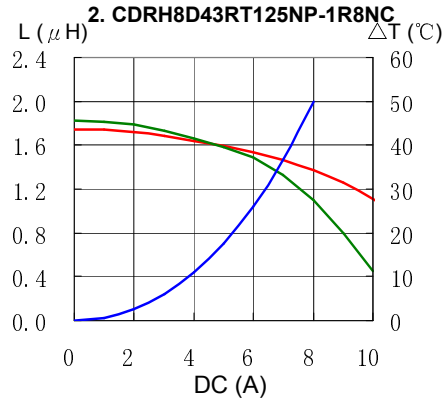
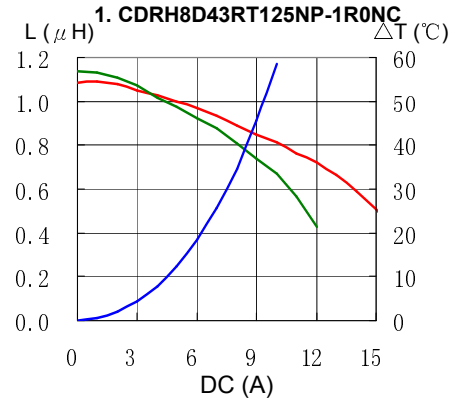

# SMD Power Inductor CDRH8D43R/T125



## Saturation Current & Temperature Rise Graph

— L (20°C) — L (125°C) —  $\Delta T$

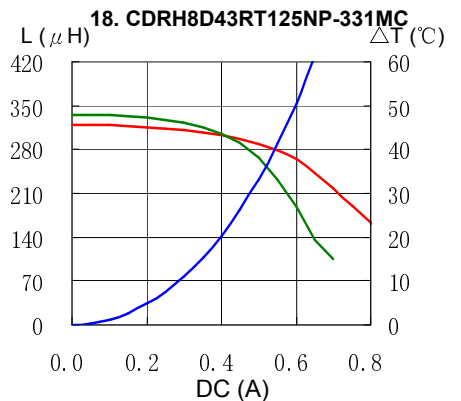
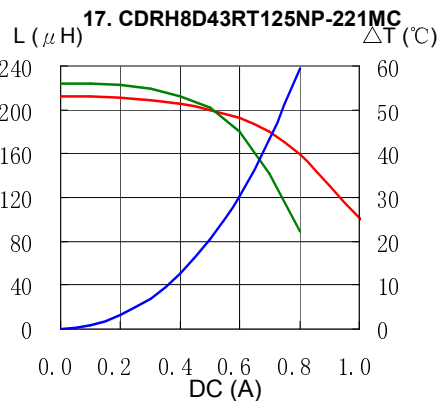
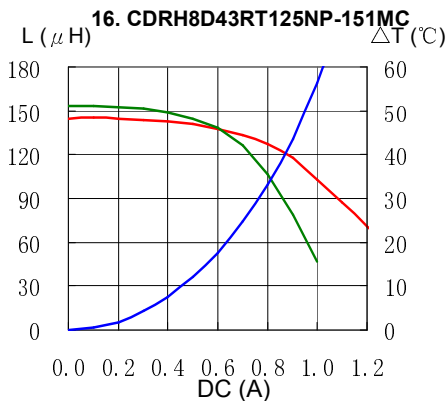
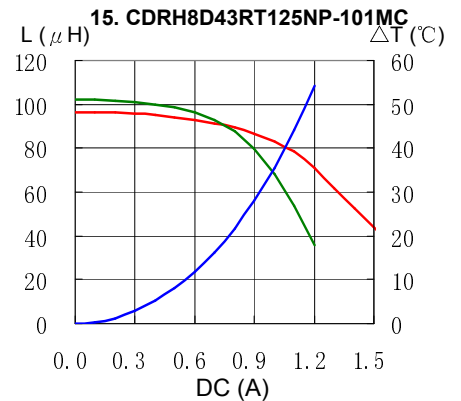
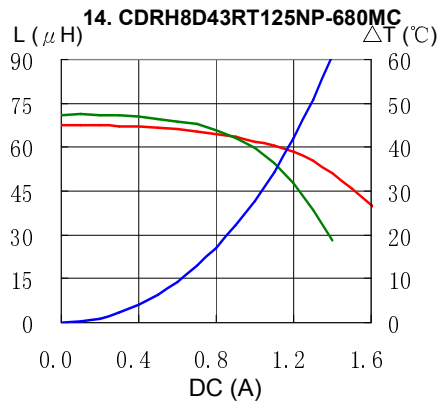
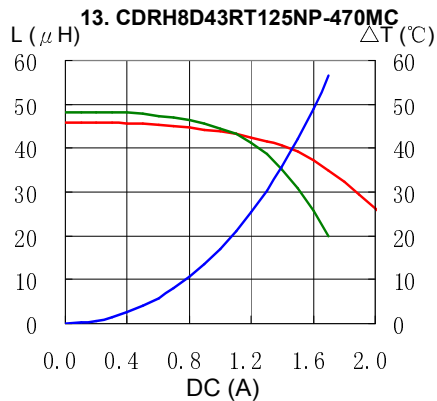

## Solder Reflow Condition

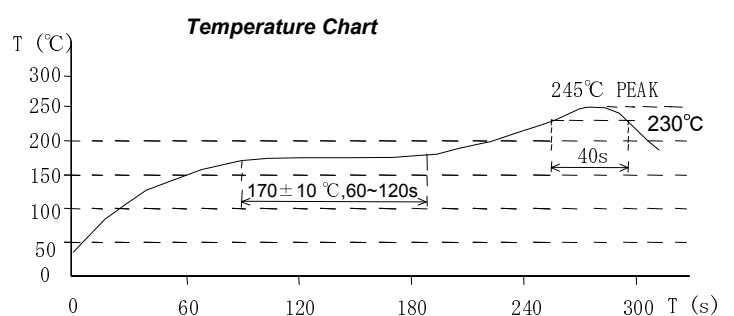
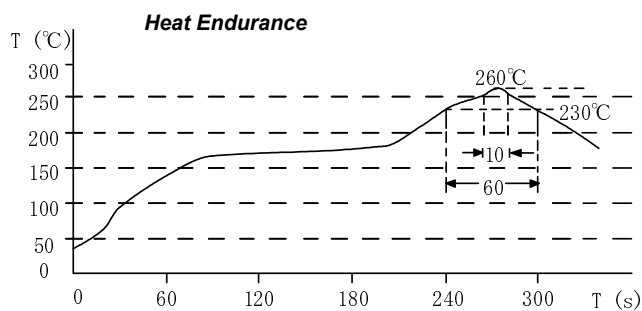

Please refer to the sales offices on our website - <http://www.sumida.com>

**Hong Kong**  
Tel.+852-2880-6781  
FAX.+852-2565-9600  
[sales@hk.sumida.com](mailto:sales@hk.sumida.com)

**Saitama(Japan)**  
Tel.+81-48-691-7300  
FAX.+81-48-691-7340  
[sales@jp.sumida.com](mailto:sales@jp.sumida.com)

**Chicago**  
Tel.+1-847-545-6700  
FAX. +1-847-545-6720  
[sales@us.sumida.com](mailto:sales@us.sumida.com)

**Shanghai**  
Tel.+86-21-5836-3299  
FAX.+86-21-5836-3266  
[shanghai.sales@cn.sumida.com](mailto:shanghai.sales@cn.sumida.com)

**Seoul**  
Tel.+82-2-6237-0777  
FAX.+82-2-6237-0778  
[sales@kr.sumida.com](mailto:sales@kr.sumida.com)

**Oberzell**  
Tel.+49-8591-937-0  
FAX. +49-8591-937-103  
[contact@eu.sumida.com](mailto:contact@eu.sumida.com)

**Shenzhen**  
Tel.+86-755-8291-0228  
FAX.+86-755-8291-0338  
[shenzhen.sales@cn.sumida.com](mailto:shenzhen.sales@cn.sumida.com)

**Singapore**  
Tel.+65-6296-3388  
FAX.+65-6841-4426  
[sales@sg.sumida.com](mailto:sales@sg.sumida.com)

**Neumarkt**  
Tel.+49-9181-4509-110  
FAX. +49-9181-4509-310  
[infocomp@eu.sumida.com](mailto:infocomp@eu.sumida.com)

**Taipei**  
Tel.+886-2-8751-2737  
FAX.+886-2-8751-2738  
[sales@tw.sumida.com](mailto:sales@tw.sumida.com)

**San Jose**  
Tel.+1-408-321-9660  
FAX.+1-408-321-9308  
[sales@us.sumida.com](mailto:sales@us.sumida.com)