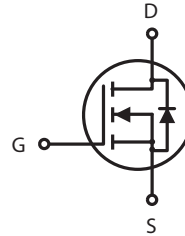

**N-Channel Logic Level Enhancement Mode Field Effect Transistor****PRODUCT SUMMARY**

V _{DSS}	I _D	R _{DS(ON)} (mΩ) Max
100V	38A	30 @ V _{GS} =10V

FEATURES

- Super high dense cell design for low R_{DS(ON)}.
- Rugged and reliable.
- TO-263 package.

**ABSOLUTE MAXIMUM RATINGS (T_C=25°C unless otherwise noted)**

Symbol	Parameter	Limit	Units
V _{DS}	Drain-Source Voltage	100	V
V _{GS}	Gate-Source Voltage	±20	V
I _D	Drain Current-Continuous ^c	T _C =25°C	38
		T _C =70°C	31.8
I _{DM}	-Pulsed ^{a c}	112	A
E _{AS}	Single Pulse Avalanche Energy ^d	100	mJ
P _D	Maximum Power Dissipation	T _C =25°C	136
		T _C =70°C	95
T _J , T _{STG}	Operating Junction and Storage Temperature Range	-55 to 175	°C

THERMAL CHARACTERISTICS

R _{θ JC}	Thermal Resistance, Junction-to-Case	1.1	°C/W
R _{θ JA}	Thermal Resistance, Junction-to-Ambient	62.5	°C/W

STB1082

Ver 1.0

ELECTRICAL CHARACTERISTICS (T_C=25°C unless otherwise noted)

Symbol	Parameter	Conditions	Min	Typ	Max	Units
OFF CHARACTERISTICS						
BV _{DSS}	Drain-Source Breakdown Voltage	V _{GS} =0V , I _D =250uA	100			V
I _{DSS}	Zero Gate Voltage Drain Current	V _{DS} =80V , V _{GS} =0V			1	uA
I _{GSS}	Gate-Body leakage current	V _{GS} = ±20V , V _{DS} =0V			±100	nA
ON CHARACTERISTICS						
V _{GS(th)}	Gate Threshold Voltage	V _{DS} =V _{GS} , I _D =250uA	2.0	3.0	4.0	V
R _{DS(ON)}	Drain-Source On-State Resistance	V _{GS} =10V , I _D =19A		24	30	m ohm
g _{FS}	Forward Transconductance	V _{DS} =10V , I _D =19A		56		S
DYNAMIC CHARACTERISTICS^b						
C _{ISS}	Input Capacitance	V _{DS} =25V, V _{GS} =0V f=1.0MHz		1217		pF
C _{OSS}	Output Capacitance			147		pF
C _{RSS}	Reverse Transfer Capacitance			98		pF
SWITCHING CHARACTERISTICS^b						
t _{D(ON)}	Turn-On DelayTime	V _{DD} =50V I _D =1A		31		ns
t _r	Rise Time			33		ns
t _{D(OFF)}	Turn-Off DelayTime	V _{GS} =10V R _{GEN} = 6 ohm		22		ns
t _f	Fall Time			36		ns
Q _g	Total Gate Charge	V _{DS} =50V, I _D =19A, V _{GS} =10V		19		nC
Q _{gs}	Gate-Source Charge	V _{DS} =50V, I _D =19A, V _{GS} =10V		2.9		nC
Q _{gd}	Gate-Drain Charge			5.1		nC
DRAIN-SOURCE DIODE CHARACTERISTICS						
V _{SD}	Diode Forward Voltage	V _{GS} =0V, I _S =6A		0.78	1.3	V
Notes						
<p>a.Pulse Test:Pulse Width < 10us, Duty Cycle < 1%.</p> <p>b.Guaranteed by design, not subject to production testing.</p> <p>c.Drain current limited by maximum junction temperature.</p> <p>d.Starting T_J=25°C, L=0.5mH, V_{DD} = 50V.</p> <p>e.Mounted on FR4 Board of 1 inch² , 2oz.</p>						

Apr,08,2016

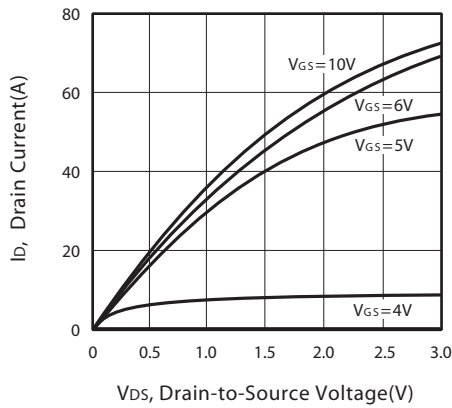

Figure 1. Output Characteristics

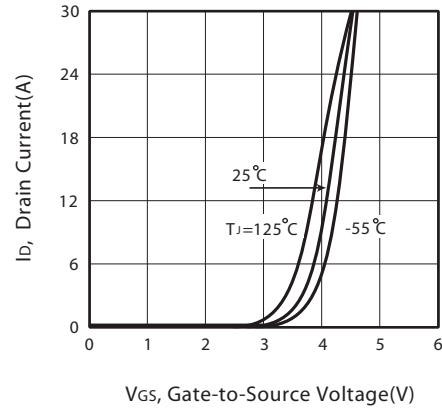

Figure 2. Transfer Characteristics

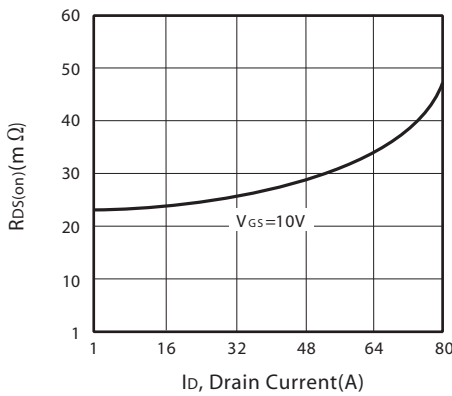

Figure 3. On-Resistance vs. Drain Current and Gate Voltage

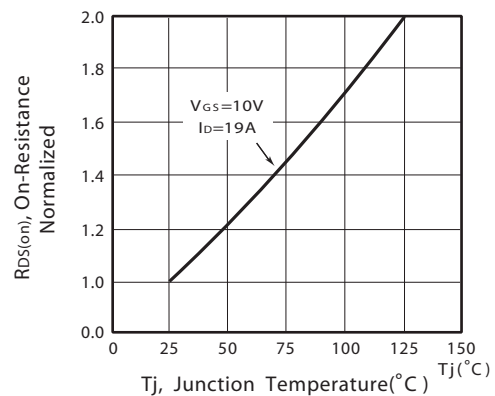

Figure 4. On-Resistance Variation with Drain Current and Temperature

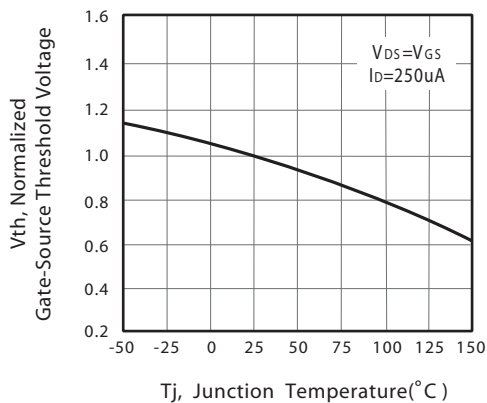

Figure 5. Gate Threshold Variation with Temperature

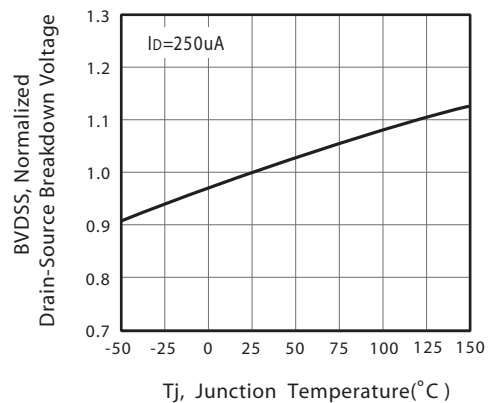

Figure 6. Breakdown Voltage Variation with Temperature

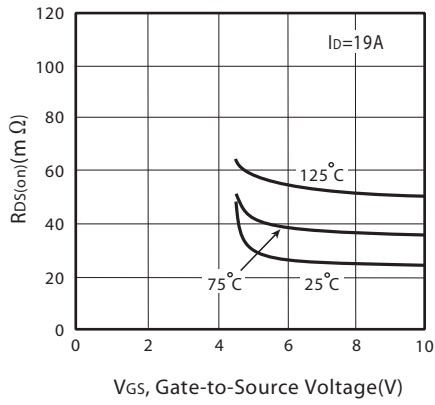

Figure 7. On-Resistance vs. Gate-Source Voltage

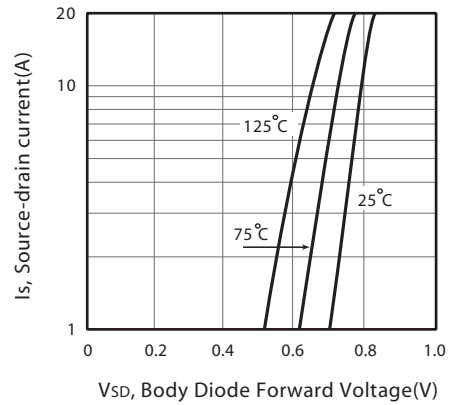

Figure 8. Body Diode Forward Voltage Variation with Source Current

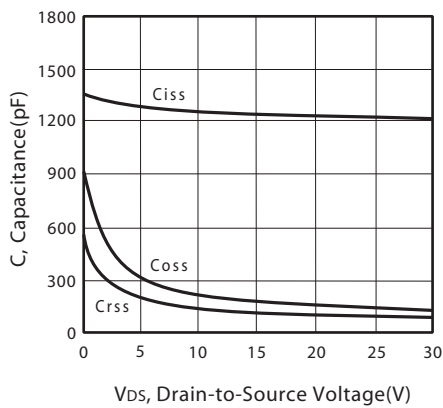

Figure 9. Capacitance

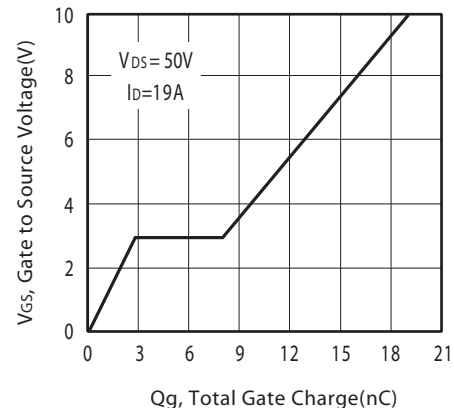

Figure 10. Gate Charge

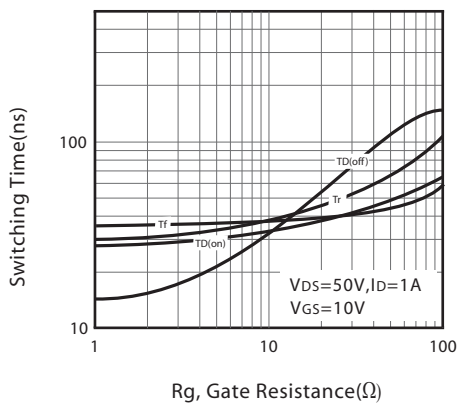

Figure 11. switching characteristics

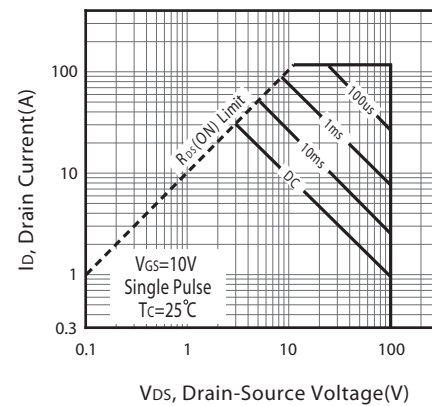
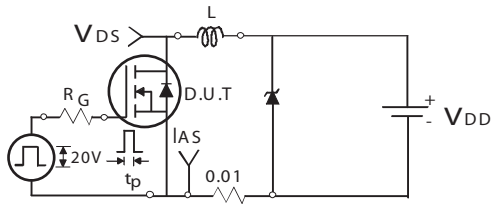
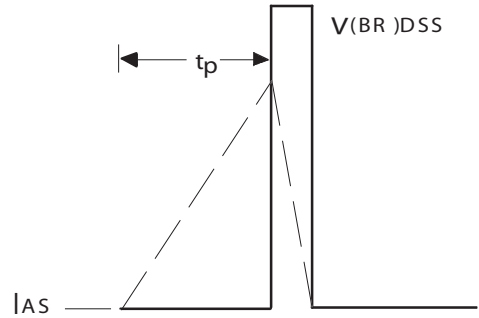

Figure 12. Maximum Safe Operating Area



Unclamped Inductive Test Circuit

Figure 13a.



Unclamped Inductive Waveforms

Figure 13b.

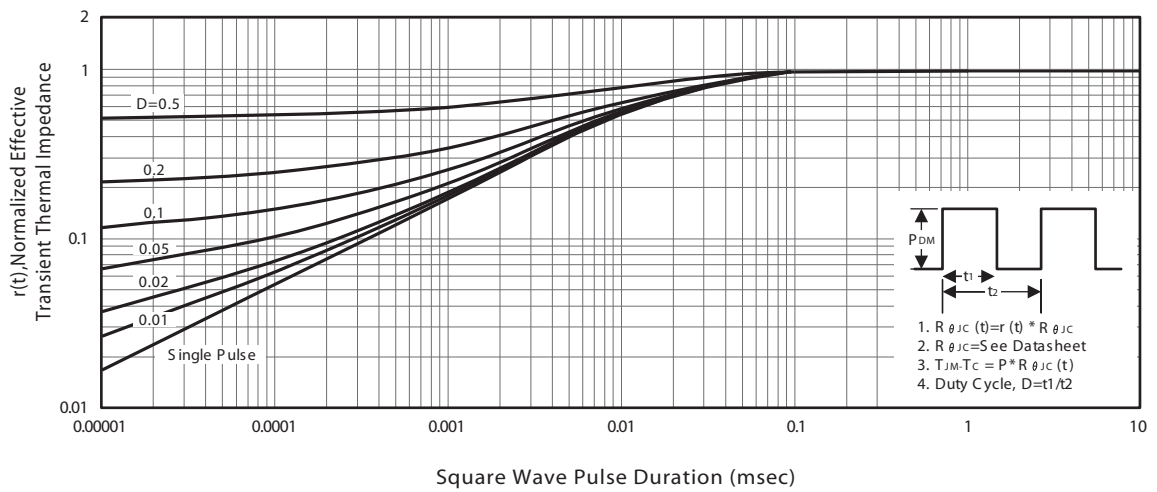
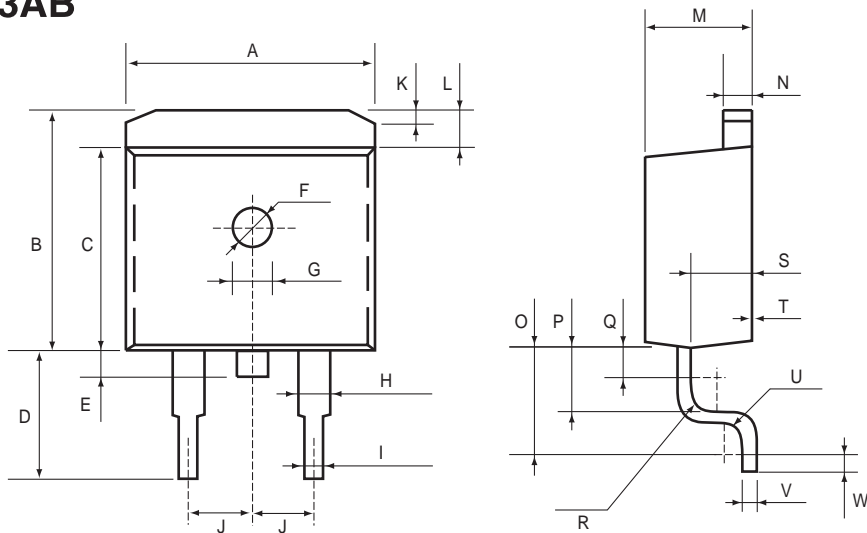

Figure 14. Normalized Thermal Transient Impedance Curve

PACKAGE OUTLINE DIMENSIONS

TO-263AB



SYMBOLS	MILLIMETERS		INCHES	
	MIN	MAX	MIN	MAX
A	9.9	10.5	0.390	0.413
B	9.5	10.3	0.374	0.406
C	8.3	8.9	0.327	0.350
D	4.7	5.5	0.185	0.217
E	1.5		0.059	
F	φ 1.6		φ 0.063	
G	1.0	1.4	0.039	0.055
H	1.07	1.47	0.042	0.058
I	0.76	1.06	0.030	0.042
J	2.04	3.04	0.080	0.120
K	0.2	0.6	0.0079	0.024
L	1.4		0.055	
M	4.24	4.64	0.167	0.183
N	1.15	1.45	0.045	0.057
O	3.25	3.75	0.128	0.148
P	2.3		0.091	
Q	1.6		0.063	
R	R0.4	R1.0	R0.0158	R0.0394
S	2.7 MAX		0.106 MAX	
T	0.0	0.3	0.0000	0.0118
U	R0.4	R1.0	R0.0158	R0.0394
V	0.3	0.5	0.0118	0.0197
W	1.2 min		0.047 min	

STB1082

Ver 1.0

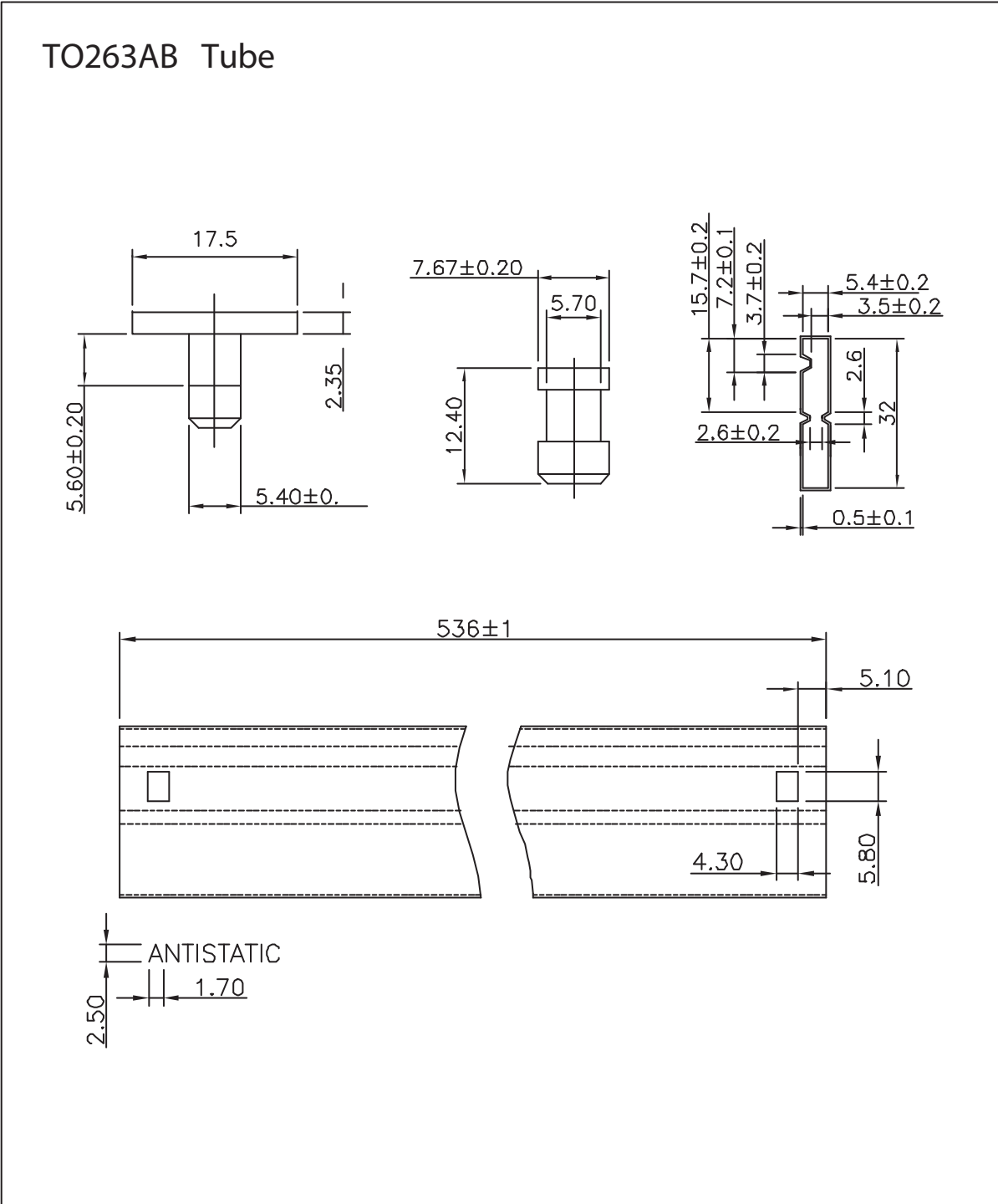

Apr,08,2016

TOP MARKING DEFINITION

