

**DFNWB5×2-6L-A Plastic-Encapsulate MOSFETS**

**CJND8804 Dual N-Channel MOSFET**

$V_{(BR)DSS}$	$R_{DS(on)MAX}$	$I_D$
20V	13mΩ@10V	8A
	14mΩ@4.5V	
	15.5mΩ@3.8V	
	19mΩ@2.5V	
	27mΩ@1.8V	

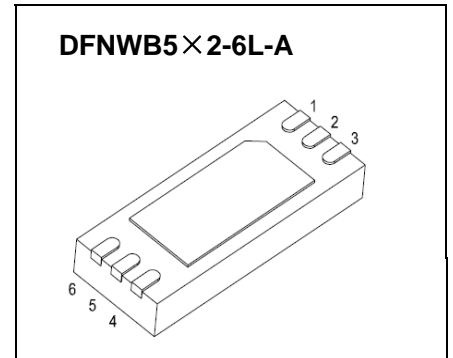

**DESCRIPTION**

The CJND8804 uses advanced trench technology to provide excellent  $R_{DS(on)}$  and low gate charge. It is ESD protected. This device is suitable for use as a uni-directional or bi-directional load switch, facilitated by its common-drain configuration.

**MARKING:**

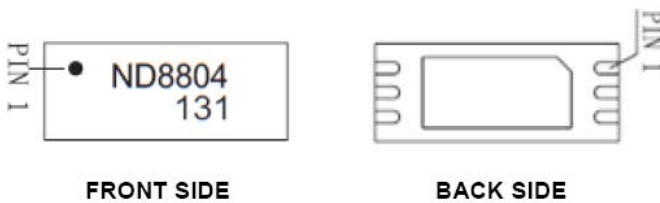

**Equivalent Circuit**

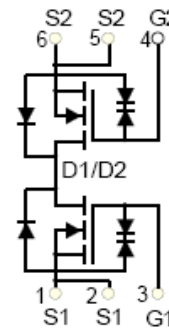

**MAXIMUM RATINGS ( $T_a=25^{\circ}C$  unless otherwise noted)**

Parameter	Symbol	Value	Unit
Drain-Source Voltage	$V_{DS}$	20	V
Gate-Source Voltage	$V_{GS}$	±12	V
Continuous Drain Current	$I_D$	8	A
Pulsed Drain Current	$I_{DM}^*$	30	A
Thermal Resistance from Junction to Ambient(note1)	$R_{\theta JA}$	175	$^{\circ}C/W$
Thermal Resistance from Junction to Ambient(note2)		70	$^{\circ}C/W$
Junction Temperature	$T_j$	150	$^{\circ}C$
Storage Temperature	$T_{stg}$	-55~+150	$^{\circ}C$
Lead Temperature for Soldering Purposes(1/8" from case for 10 s)	$T_L$	260	$^{\circ}C$

\*Repetitive rating: Pluse width limited by junction temperature.

Note: 1.When mounted on a minimum pad.

2.When mounted on 1 in<sup>2</sup> of 2oz copper board.

# MOSFET ELECTRICAL CHARACTERISTICS

$T_a=25^\circ\text{C}$  unless otherwise specified

Parameter	Symbol	Test Condition	Min	Typ	Max	Unit
<b>STATIC PARAMETERS</b>						
Drain-source breakdown voltage	$V_{(BR)DSS}$	$V_{GS} = 0V, I_D = 250\mu A$	20			V
Zero gate voltage drain current	$I_{DSS}$	$V_{DS} = 16V, V_{GS} = 0V$			10	$\mu A$
Gate-body leakage current	$I_{GSS}$	$V_{GS} = \pm 10V, V_{DS} = 0V$			$\pm 10$	$\mu A$
Gate threshold voltage (note 1)	$V_{GS(th)}$	$V_{DS} = V_{GS}, I_D = 250\mu A$	0.5		1	V
Drain-source on-resistance (note 1)	$R_{DS(on)}$	$V_{GS} = 10V, I_D = 8A$			13	m $\Omega$
		$V_{GS} = 4.5V, I_D = 5A$			14	m $\Omega$
		$V_{GS} = 3.8V, I_D = 5A$			15.5	m $\Omega$
		$V_{GS} = 2.5V, I_D = 4A$			19	m $\Omega$
		$V_{GS} = 1.8V, I_D = 3A$			27	m $\Omega$
Forward tranconductance (note 1)	$g_{FS}$	$V_{DS} = 5V, I_D = 8A$		17		S
Diode forward voltage(note 1)	$V_{SD}$	$I_S = 1A, V_{GS} = 0V$			1	V
<b>DYNAMIC PARAMETERS (note 2)</b>						
Input Capacitance	$C_{iss}$	$V_{DS} = 10V, V_{GS} = 0V, f = 1MHz$		1800		pF
Output Capacitance	$C_{oss}$			230		pF
Reverse Transfer Capacitance	$C_{rss}$			200		pF
Total gate charge	$Q_g$	$V_{DS} = 10V, V_{GS} = 4.5V, I_D = 8A$		17.9		nC
Gate-source charge	$Q_{gs}$			1.5		nC
Gate-drain charge	$Q_{gd}$			4.7		nC
<b>SWITCHING PARAMETERS (note 2)</b>						
Turn-on delay time	$t_{d(on)}$	$V_{GS} = 10V, V_{DD} = 10V,$ $R_L = 1.2\Omega, R_{GEN} = 3\Omega$		2.5		ns
Turn-on rise time	$t_r$			7.2		ns
Turn-off delay time	$t_{d(off)}$			49		ns
Turn-off fall time	$t_f$			10.8		ns

**Notes :**

1. Pulse Test : Pulse width  $\leq 300\mu s$ , duty cycle  $\leq 0.5\%$ .
2. Guaranteed by design, not subject to production testing.

# Typical Characteristics

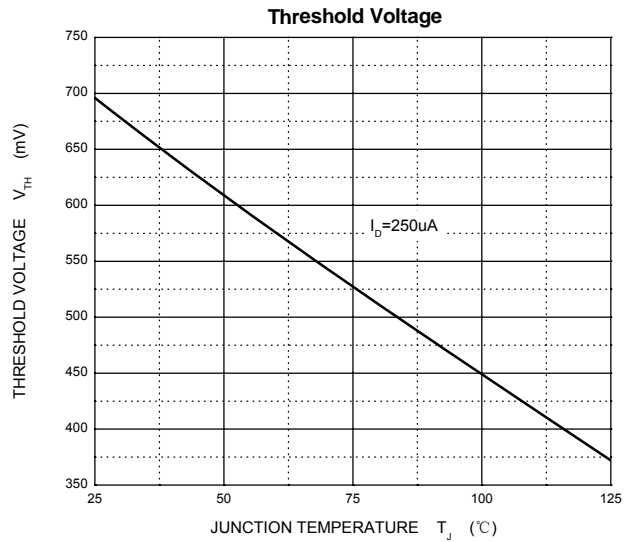
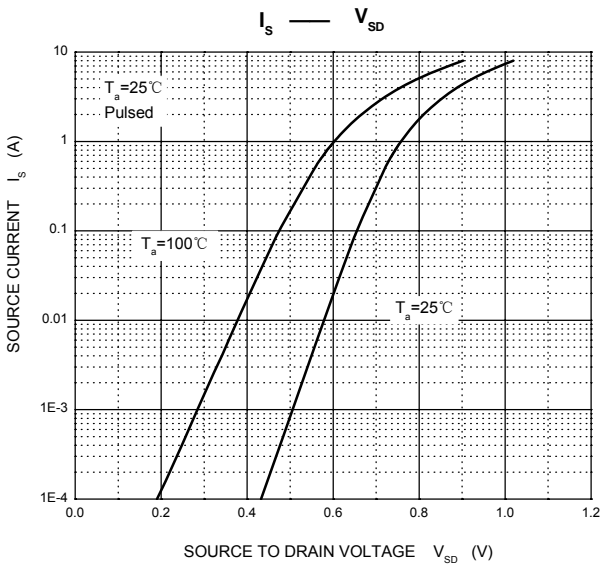
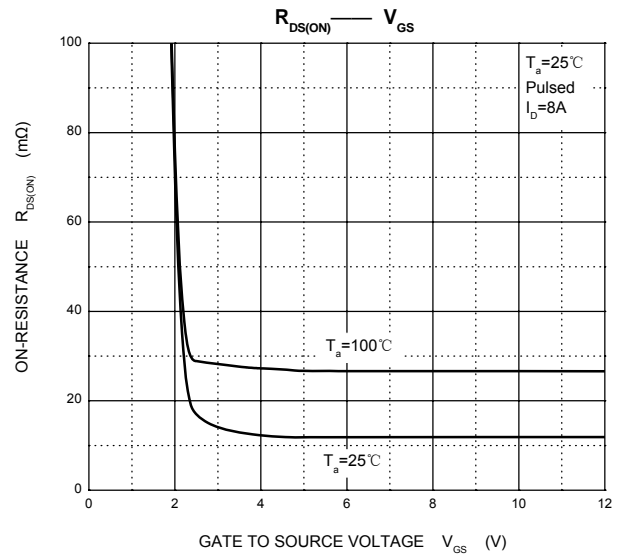
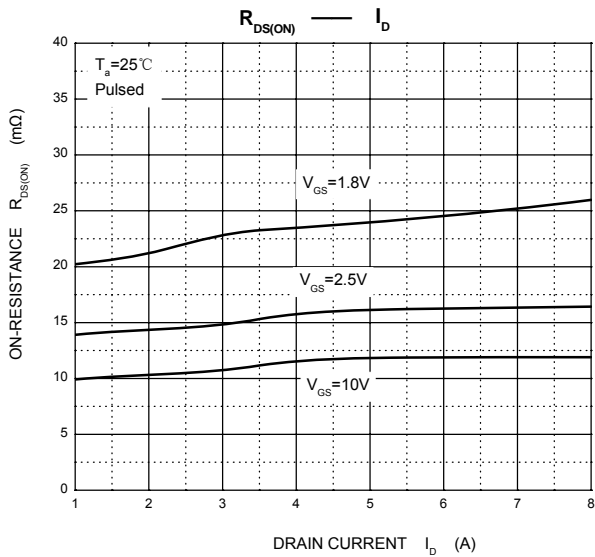
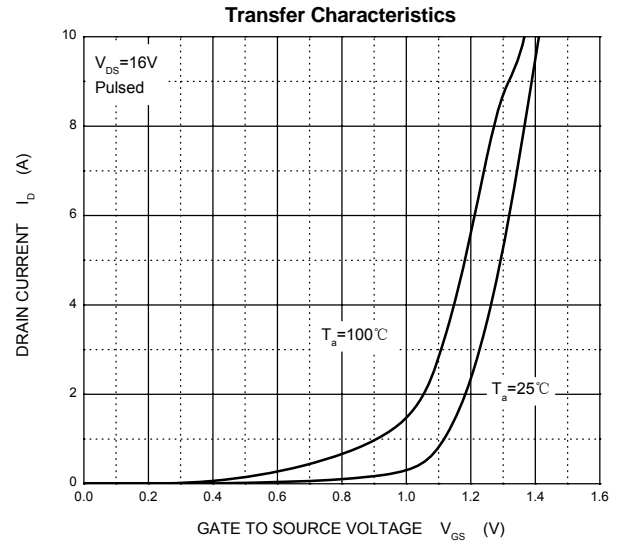
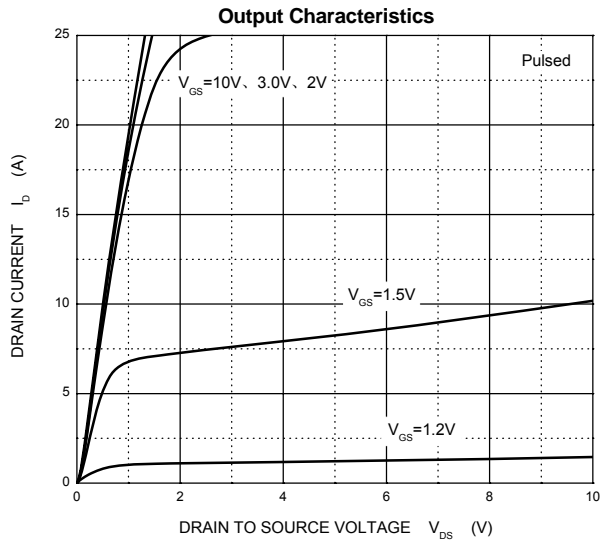

## DFNWB5X2-6L-A Package Outline Dimensions

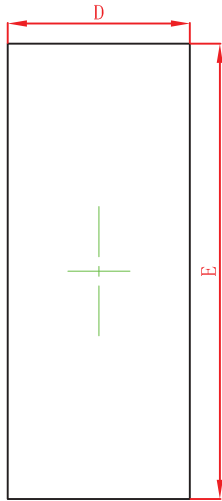

Top View

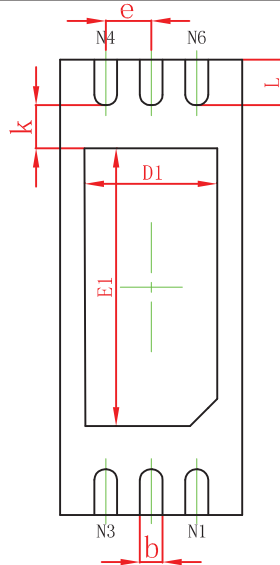

Bottom View

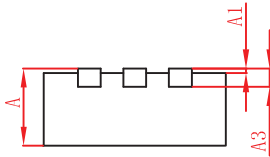

Side View

Symbol	Dimensions In Millimeters		Dimensions In Inches	
	Min.	Max.	Min.	Max.
A	0.700	0.800	0.028	0.031
A1	0.000	0.050	0.000	0.002
A3	0.203REF.		0.008REF.	
D	1.924	2.076	0.076	0.082
E	4.924	5.076	0.194	0.200
D1	1.350	1.550	0.053	0.061
E1	2.950	3.150	0.116	0.124
k	0.200MIN.		0.008MIN.	
b	0.200	0.300	0.008	0.012
e	0.500TYP.		0.020TYP.	
L	0.424	0.576	0.017	0.023

## DFNWB5X2-6L-A Suggested Pad Layout

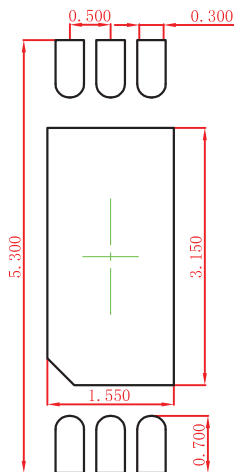

**Note:**

1. Controlling dimension: in millimeters.
2. General tolerance:  $\pm 0.050\text{mm}$ .
3. The pad layout is for reference purposes only.

**NOTICE**

JCET reserve the right to make modifications, enhancements, improvements, corrections or other changes without further notice to any product herein. JCET does not assume any liability arising out of the application or use of any product described herein.

# DFNWB5X2-6L Tape and Reel

## DFNWB5\*2-6L Embossed Carrier Tape

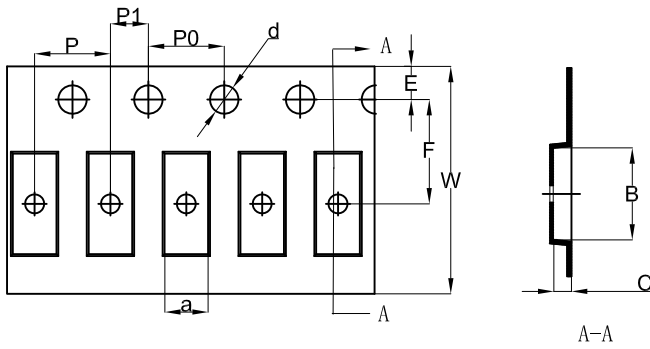

### Packaging Description:

DFNWB5\*2-6L parts are shipped in tape. The carrier tape is made from a dissipative (carbon filled) polycarbonate resin. The cover tape is a multilayer film (Heat Activated Adhesive in nature) primarily composed of polyester film, adhesive layer, sealant, and anti-static sprayed agent. These reeled parts in standard option are shipped with 2,500 units per 7" or 17.8cm diameter reel. The reels are clear in color and is made of polystyrene plastic (anti-static coated).

ALL DIM IN mm

Dimensions are in millimeter										
Pkg type	a	B	C	d	E	F	P0	P	P1	W
DFNWB2*2-6L	2.30	5.30	1.05	Ø1.50	1.75	5.50	4.00	4.00	2.00	12.00

## DFNWB5\*2-6L Tape Leader and Trailer

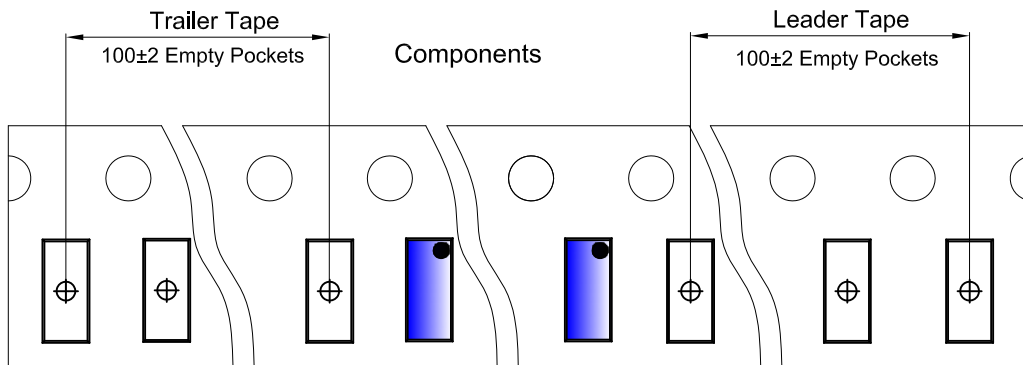

## DFNWB5\*2-6L Reel

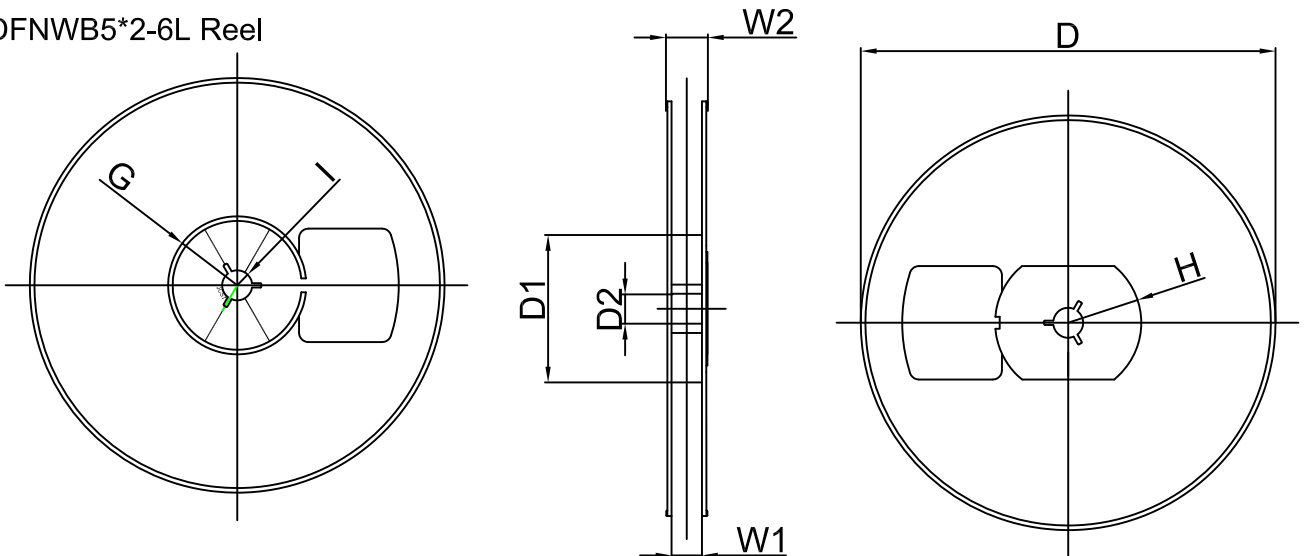

Dimensions are in millimeter								
Reel Option	D	D1	D2	G	H	I	W1	W2
7"Dia	Ø180.00	60.00	13.00	R30.00	R32.00	R6.50	13.20	16.50

REEL	Reel Size	Box	Box Size(mm)	Carton	Carton Size(mm)	G.W.(kg)
2500 pcs	7 inch	25,000 pcs	203×203×195	100,000 pcs	438×438×220	