



SRS50-HXA0-K22

SRS/SRM50

MOTOR FEEDBACK SYSTEMS ROTARY HIPERFACE®

SICK
Sensor Intelligence.

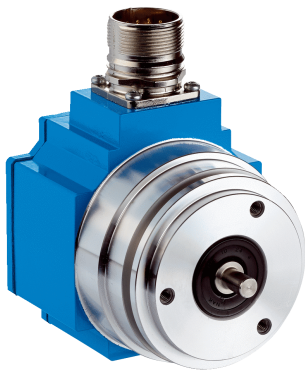

Illustration may differ



Ordering information

Type	Part no.
SRS50-HXA0-K22	1037100

Other models and accessories → www.sick.com/SRS_SRM50

Detailed technical data

Performance

Number of sine/cosine periods per revolution	1,024
Number of the absolute ascertainable revolutions	1
Total number of steps	32,768
Measuring step	0.3 Winkelsekunden For interpolation of the sine/cosine signals with, e. g., 12 bits
Integral non-linearity typ.	± 45 Winkelsekunden, Error limits for evaluating sine/cosine period
Differential non-linearity	± 7 Winkelsekunden, Non-linearity within a sine/cosine period
Operating speed	6,000 min ⁻¹ , up to which the absolute position can be reliably produced

Interfaces

Type of code for the absolute value	Binary
Code sequence	Increasing, when turning the shaft For clockwise rotation, looking in direction "A" (see dimensional drawing), for clockwise shaft rotation, looking in direction "A" (see dimensional drawing)
Communication interface	HIPERFACE®
Available memory area	1,792 Byte

Electrical data

Supply voltage range	7 V DC ... 12 V DC
Recommended supply voltage	8 V DC
Operating power consumption (no load)	≤ 80 mA ¹⁾
Output frequency for sine/cosine signals	0 kHz ... 200 kHz

¹⁾ Without load.

Mechanical data

Shaft version	Solid shaft
Flange type/stator coupling	Servo flange / stator coupling
Dimensions	See dimensional drawing
Weight	0.2 g

Moment of inertia of the rotor	25 gcm ²
Operating speed	6,000 min ⁻¹ , 12,000 U/min
Angular acceleration	≤ 200,000 rad/s ²
Operating torque	1 Ncm
Start up torque	1.5 Ncm
Permissible Load capacity of shaft	40 N (radial) 20 N (axial)
Life of ball bearings	3.6 x 10 ⁹ revolutions
Connection type	Male connector M12, 8-pin, radial

Ambient data

Operating temperature range	-30 °C ... +85 °C
Storage temperature range	-30 °C ... +90 °C, without package
Relative humidity/condensation	90 %, Condensation not permitted
Resistance to shocks	100 g, 10 ms, 10 ms (according to EN 60068-2-27)
Frequency range of resistance to vibrations	20 g, 10 Hz ... 2,000 Hz (according to EN 60068-2-6)
EMC	According to EN 61000-6-2 and EN 61000-6-3 ¹⁾
Enclosure rating	IP40, with mating connector inserted (according to IEC 60529)

¹⁾ The EMC according to the standards quoted is achieved when the motor feedback system is mounted in an electrically conductive housing, which is connected to the central earthing point of the motor controller via a cable screen. The GND (OV) connection of the supply voltage is also grounded here. If other screening concepts are used, users must perform their own tests.

Classifications

ECl@ss 5.0	27270590
ECl@ss 5.1.4	27270590
ECl@ss 6.0	27270590
ECl@ss 6.2	27270590
ECl@ss 7.0	27270590
ECl@ss 8.0	27270590
ECl@ss 8.1	27270590
ECl@ss 9.0	27270590
ETIM 5.0	EC001486
ETIM 6.0	EC001486
UNSPSC 16.0901	41112113

Dimensional drawing (Dimensions in mm (inch))

General tolerances according to DIN ISO 2768-mk

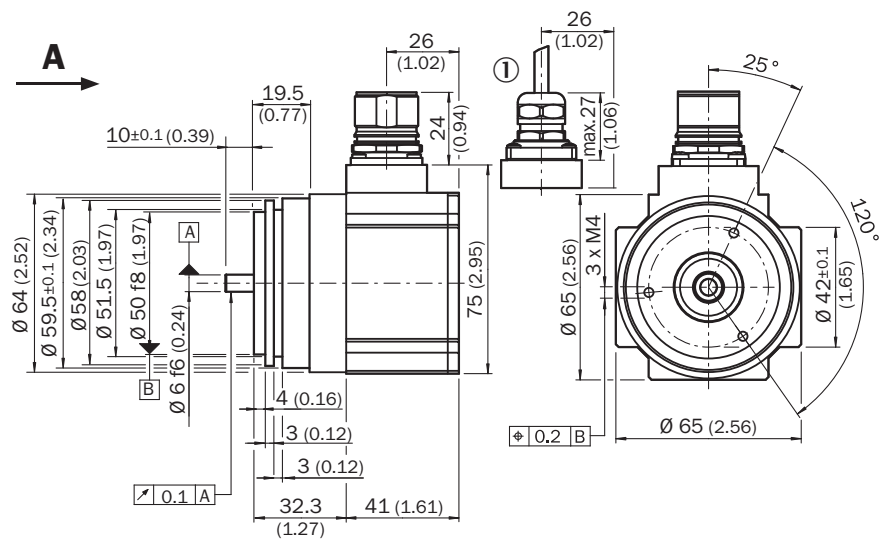

① R = min. bending radius 40 mm

PIN assignment

View of the M23 male connector plug-in face

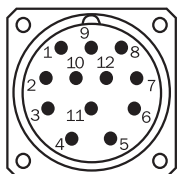

PIN	Signal	Colour of Wires	Explanation
1	REFCOS	black	Process data channel
2	Data +	grey or yellow	RS-485-parameter channel
3	N. C.	-	N. C.
4	N. C.	-	N. C.
5	SIN	white	Process data channel
6	REFSIN	brown	Process data channel
7	Data -	green or purple	RS-485-parameter channel
8	COS	pink	Process data channel
9	N. C.	-	N. C.
10	GND	blue	Ground connection
11	N. C.	-	N. C.
12	Us	red	7 ... 12 V Supply voltage

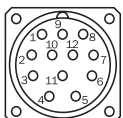

View of the plug-in face

Screen connection on connector housing

N. C. = Not connected



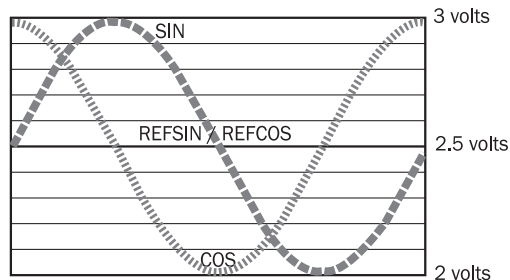

Diagram

Signal diagram for clockwise rotation of the shaft looking in direction "A" (see dimensional drawing) 1 period = 360 ° : 1024



Recommended accessories

Other models and accessories → www.sick.com/SRS_SRM50

	Brief description	Type	Part no.
Plug connectors and cables			
	Head A: cable Head B: cable Cable: HIPERFACE®, HIPERFACE®, drag chain use, PUR, halogen-free, shielded	LTG-2708-MW	6028361
	Head A: female connector, M23, 12-pin, straight Head B: male connector, M23, 17-pin, straight Cable: HIPERFACE®, unshielded, 1 m	DSL-2317-G01MJB2	2071328
	Head A: female connector, JST, 8-pin, straight Head B: male connector, M23, 17-pin, straight Cable: HIPERFACE®, unshielded, 1 m	DSL-2317-G01MJB6	2071327
	Head A: female connector, M12, 8-pin, straight Head B: male connector, M23, 17-pin, straight Cable: HIPERFACE®, unshielded, 1 m	DSL-2317-G01MJC1	2071329
	Head A: female connector, terminal box, 8-pin, straight Head B: male connector, M23, 17-pin, straight Cable: HIPERFACE®, unshielded, 1 m	DSL-2317-G01MJC6	2071330
Programming and configuration tools			
	SVip® LAN programming tool for all motor feedback systems	PGT-11-S LAN	1057324
	SVip® WLAN programming tool for all motor feedback systems	PGT-11-S WLAN	1067474

SICK AT A GLANCE

SICK is one of the leading manufacturers of intelligent sensors and sensor solutions for industrial applications. A unique range of products and services creates the perfect basis for controlling processes securely and efficiently, protecting individuals from accidents and preventing damage to the environment.

We have extensive experience in a wide range of industries and understand their processes and requirements. With intelligent sensors, we can deliver exactly what our customers need. In application centers in Europe, Asia and North America, system solutions are tested and optimized in accordance with customer specifications. All this makes us a reliable supplier and development partner.

Comprehensive services complete our offering: SICK LifeTime Services provide support throughout the machine life cycle and ensure safety and productivity.

For us, that is “Sensor Intelligence.”

WORLDWIDE PRESENCE:

Contacts and other locations –www.sick.com