

Aluminum Electrolytic, 105C LowZ, EST, 470 uF, 20%, 63 V, -40/+105C, Lead Spacing = 5mm

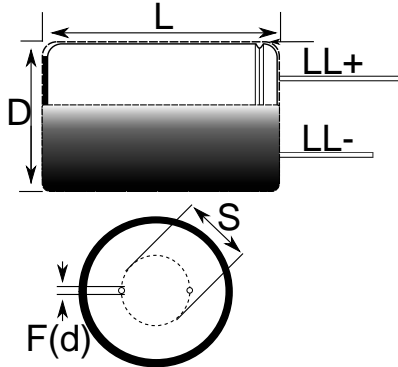

Note: '()' correspond to the letters used in the product bulletin

Dimensions	
D	13mm +/-0.5mm
L	30mm +2mm
S	5mm +/-0.5mm
LL Negative	15mm MIN
LL Positive	20mm MIN
F	0.6mm NOM

Packaging Specifications	
Packaging:	Bulk, Bag
Packaging Quantity:	1200

General Information	
Dielectric:	Aluminum Electrolytic
Series:	EST
Description:	LowZ, Long Life, Single Ended Aluminum Electrolytic
Features:	Low Z, Long Life, Low Impedance
RoHS:	Yes
Lead:	Wire Leads

Specifications	
Capacitance:	470 uF
Capacitance Tolerance:	20%
Voltage DC:	63 VDC, 79 VDC (Surge)
Temperature Range:	-40/+105C
Rated Temperature:	105C
Life:	10000 Hrs
Dissipation Factor:	14%
Resistance:	0.1 Ohms (100kHz 20C)
Current:	905 mAmps (100kHz 105C)
Leakage Current:	296.1 uA (2min 20C)
Impedance Ratio at -25C:	2
Impedance Ratio at -40C:	3