

Features and Benefits

- Programmable high speed current sensor
- Triaxis[®] Technology
- Very high sensitivity due to Integrated Magnetic Concentrator (IMC-Hall[®])
- Wideband: DC to 200kHz
- Very short response time: 3µs
- Programmable linear transfer characteristic
- Selectable analog ratiometric output
- SO-8 package, RoHS compliant
- Lead free component, suitable for lead free soldering profile 260°C (target), MSL3

Application Examples

- Inverter HEV and EV
- BLDC motor current monitoring
- Smart fuse (over-current detection)
- AC/DC Converter
- DC/AC Converter (Inverter)
- DC/DC switched mode power supply

Ordering Information

Part No.	Temperature Code	Package	Option code	Packing Form	Sensitivity Range (Default)
MLX91208	L (-40°C to 150°C)	DC (SOIC)	CAL-000 (low field)	TU/RE (tube/reel)	100-700mV/mT (250mV/mT)
MLX91208	L (-40°C to 150°C)	DC (SOIC)	CAH-000 (high field)	TU/RE (tube/reel)	50-300mV/mT (100mV/mT)
MLX91208	L (-40°C to 150°C)	DC (SOIC)	CAV-000 (v. high f.)	TU/RE (tube/reel)	30-200mV/mT (40mV/mT)
MLX91208	L (-40°C to 150°C)	DC (SOIC)	CAV-001 (v. high f.)	TU/RE (tube/reel)	30-200mV/mT (60mV/mT)

Ordering example: MLX91208LDC-CAH-000-RE

1 Functional Diagram

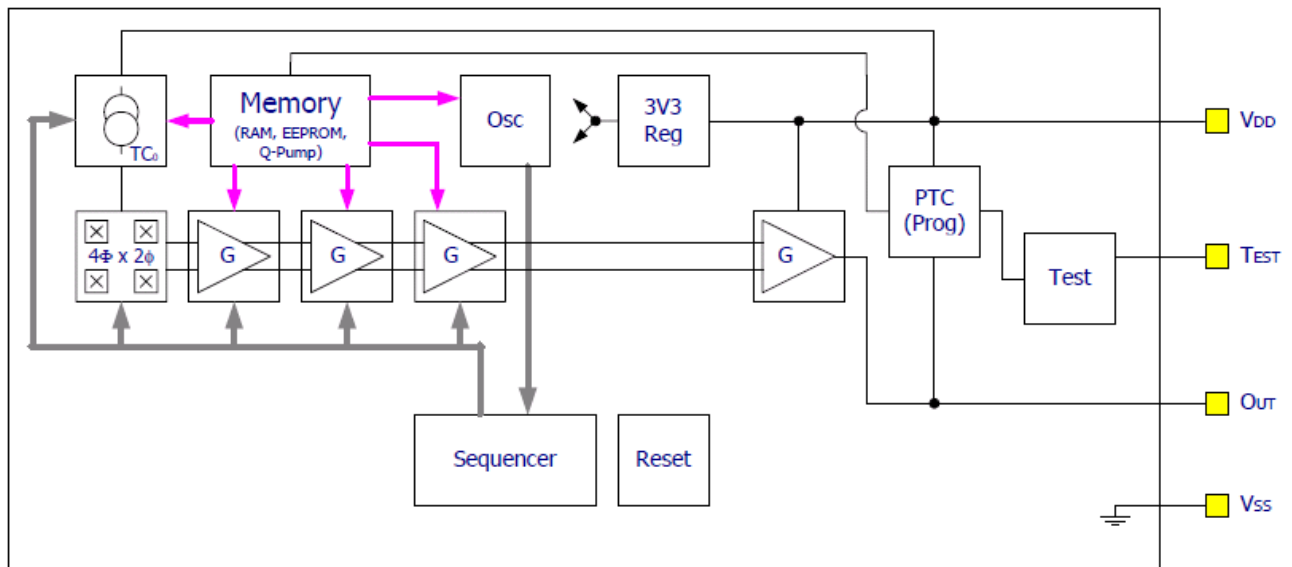

Figure 1: Block diagram

2 General Description

The MLX91208 is a monolithic sensor IC featuring the Tria[⊗]is™ Hall technology. Conventional planar Hall technology is only sensitive to the flux density applied orthogonally to the IC surface. The IMC-Hall[®] current sensor is sensitive to the flux density applied parallel to the IC surface. This is obtained through an Integrated Magneto-Concentrator (IMC-Hall[®]) which is deposited on the CMOS die (as an additional back-end step). The IMC-Hall[®] technology is automotive qualified.

The product is a single chip Hall sensor which provides an output signal proportional to the flux density applied horizontally and is therefore suitable for current measurement. It is ideally suited as an open loop current sensor for PCB or bus bar mounting. It features small size application design and a simple construction for various current ranges from few Amperes up to 1000 Amperes.

The transfer characteristic of the MLX91208 is programmable in terms of offset, gain or temperature compensation. The linear analog output is designed for applications where a very fast response is required, such as inverter applications.

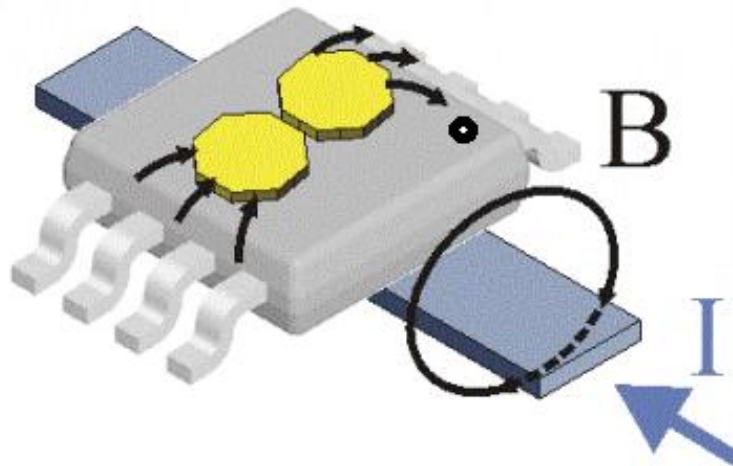

Figure 2: Typical application of MLX91208 (magnetic field generated by the current).

Table of Contents

1	Functional Diagram	1
2	General Description	2
3	Glossary of Terms	4
4	Absolute Maximum Ratings	4
5	Pin Definitions and Descriptions	4
6	General Electrical Specifications	5
7	Magnetic specification	6
	7.1 Low Field Version 10mT (marking xxL)	6
	7.2 High Field Version 25mT (marking xxH)	6
	7.3 Very High Field Version 60mT (marking xxV)	6
8	Analog output specification	7
	8.1 Timing specification	7
	8.2 Accuracy specification	8
	8.3 Remarks to the achievable accuracy	8
9	Programmable items	9
	9.1 Parameter table	9
	9.2 Sensitivity programming (RG, FG)	9
	9.3 Offset / output quiescent voltage programming (VOQ)	9
	9.4 Output ratiometry (ENRATIO)	9
	Sensitivity temperature drift programming (TC1ST, TC2ND_COLD, TC2ND_HOT)	10
	9.5	10
	9.6 Offset temperature drift programming (OFFDR2C, OFFDR2H)	10
	9.7 Noise filter (NOISEFILT)	10
	9.8 Identification code (ID)	10
10	Self diagnostic	10
11	Application information	11
	11.1 Low current measurement ± 2 -10A	11
	11.2 Medium current measurement up to ± 50 A	11
	11.3 High current measurement up to ± 1000 A	11
12	Recommended Application Diagrams	12
	12.1 Resistor and capacitor values	12
	12.2 Pull down resistor for diagnostic low	12
	12.3 Pull up resistor for diagnostic high	12
13	Typical performance	13
14	Standard information regarding manufacturability of Melexis products with different soldering processes	14
15	ESD Precautions	14
16	Package information	15
	16.1 SOIC-8 Package Dimensions	15
	16.2 SOIC-8 Pinout and Marking	15
	16.3 SOIC-8 Hall plate position	16
	SOIC-8 IMC Position and sensor active measurement dimension	16
	16.4	16
	Disclaimer	17

3 Glossary of Terms

ADC	Analog to Digital Converter
DAC	Digital to Analog Converter
DNL	Differential Non Linearity
IMC	Integrated Magneto Concentrator (IMC-Hall [®])
INL	Integral Non Linearity
LSB	Least Significant Bit
MSB	Most Significant Bit
NC	Not Connected
PTC	Programming Through Connector
TC	Temperature Coefficient in ppm/°C
Tesla	Units for the magnetic flux density, 1 mT = 10 Gauss

4 Absolute Maximum Ratings

Parameter	Symbol	Value	Units
Positive Supply Voltage (overvoltage)	V _{dd}	+10	V
Reverse Supply Voltage Protection		-0.3	V
Positive Output Voltage ⁽¹⁾		+10	V
Output Current	I _{out}	±70	mA
Reverse Output Voltage		-0.3	V
Reverse Output Current		-50	mA
Package Thermal Resistance	R _{th}	105	°C/W
Operating Ambient Temperature Range	T _A	-40 to +150	°C
Storage Temperature Range	T _S	-55 to +165	°C
Magnetic Flux Density		infinite	T

Table 1: Absolute maximum ratings

Exceeding the absolute maximum ratings may cause permanent damage. Exposure to absolute maximum rated conditions for extended periods may affect device reliability.

(1) Valid for supply=10V or supply-pin floating

5 Pin Definitions and Descriptions

Pin #	Name	Type	Function
1	VDEC	Digital	Digital Supply Voltage
3	VSS	Ground	Supply Voltage
4	TEST/MUST	Digital	Test and Factory Calibration
5	VDD	Supply	Supply Voltage
6	OUT	Analog	Current Sensor Output

Table 2: Pin definition and description

It is recommended to connect unused pins to the Ground for optimal EMC results.

6 General Electrical Specifications

Operating Parameters: $T_A = -40^{\circ}\text{C}$ to 125°C , $V_{dd} = 4.5\text{V}$ to 5.5V , $I_{out} = -2\text{mA}$ to $+2\text{mA}$, recommended application diagram in section 1, unless otherwise specified. All mentioned component values can have a $\pm 20\%$ tolerance.

Parameter	Symbol	Test Conditions	Min	Typ	Max	Units
Nominal Supply Voltage	Vdd		4.5	5	5.5	V
Supply Current	Idd	Without output load In application mode $T_A = -40^{\circ}\text{C}$ to 150°C	7	12	14	mA
DC Load Current	Iout	R_{load} in range [6k Ω , 100k Ω]	-2		2	mA
Maximum Output Current (driving capability)	I _{max}	Inside this range, output voltage reaches 3%Vdd and 97%Vdd	-2		2	mA
Output Resistance		$V_{out} = 50\% V_{dd}$, $R_L = 10\text{k}\Omega$		1	5	Ω
Output Capacitive Load	C _{load}	Capacitive load range for the stability of the output amplifier. Output amplifier optimized for the typical capacitive load.	1	2	10	nF
Output Resistive Load	R _{load}	Output resistive load for high linearity (both pull-up and pull-down resistor)	6			k Ω
Output Short Circuit Current	I _{short}	Output shorted to Vdd (Permanent)	35		180	mA
		Output shorted to Vss (Permanent)	35		180	mA
Output Leakage current	I _{leak}	High impedance mode ⁽¹⁾ $T = 150^{\circ}\text{C}$	0.5	1.5	20	μA
Output Voltage Swing (Linear Range)	V _{out_pd}	pull down $\geq 10\text{k}\Omega$	10		90	%Vdd
	V _{out_pu}	pull up $\geq 10\text{k}\Omega$	10		90	%Vdd
High-impedance mode levels ⁽¹⁾	V _{out_HiZ_pu}	pull-up $R_L \leq 25\text{k}\Omega$, $T \leq 125^{\circ}\text{C}$	95			%Vdd
	V _{out_HiZ_pd}	pull-down $R_L \leq 25\text{k}\Omega$, $T \leq 125^{\circ}\text{C}$			5	%Vdd
Under-voltage detection ⁽²⁾	V _{dd_uv d}	Low to High Voltage	3	3.3	4	V
	V _{dd_uv h}	Hysteresis	0.25	0.3	0.4	V
Over-voltage detection ⁽²⁾	V _{dd_ov d2}	Low to High Voltage	6.7		7.6	V
	V _{dd_ov h2}	Hysteresis	0.05		0.7	V
Ratiometry enable detection ⁽²⁾	V _{ratio_d}	Low to High Voltage	4		4.45	V
	V _{ratio_h}	Hysteresis	0.05		0.5	V

Table 3: General electrical parameter

- (1) Refer to chapter *Self diagnostic*, Table 10.
- (2) According to figure on the right:

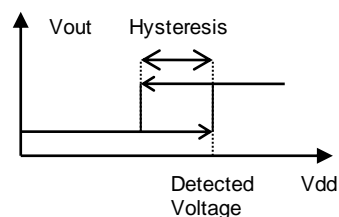

7 Magnetic specification

Operating Parameters $T_A = -40^{\circ}\text{C}$ to 125°C , $V_{dd} = 4.5\text{V}$ to 5.5V , unless otherwise specified.

7.1 Low Field Version 10mT (marking xxL)

Parameter	Symbol	Test Conditions	Min	Typ	Max	Units
Nominal Magnetic field range	Bnom		-7.5		+7.5	mT
Operational Field Range ⁽¹⁾	Bop		-10		+10	mT
Linearity Error	NL	B in range Bop Vout in [10%Vdd, 90%Vdd]	-0.7		+0.7	%FS
Hysteresis	Br	B = Bop	-10		+10	uT
Programmable Sensitivity	S		100	250	700	mV/mT
Sensitivity programming Resolution	Sres			0.1		%

Table 4: Magnetic specification for 10mT version (low field)

7.2 High Field Version 25mT (marking xxH)

Parameter	Symbol	Test Conditions	Min	Typ	Max	Units
Nominal Magnetic field range	Bnom		-20		+20	mT
Operational Field Range ⁽¹⁾	Bop		-25		+25	mT
Linearity Error	NL	B in range Bop Vout in [10%Vdd, 90%Vdd]	-0.7		+0.7	%FS
Hysteresis	Br	B = Bop	-25		+25	uT
Programmable Sensitivity	S		50	100	300	mV/mT
Sensitivity programming Resolution	Sres			0.1		%

Table 5: Magnetic specification for 25mT version (high field)

7.3 Very High Field Version 60mT (marking xxV)

Parameter	Symbol	Test Conditions	Min	Typ	Max	Units
Nominal Magnetic field range	Bnom		-50		+50	mT
Operational Field Range ⁽¹⁾	Bop		-60		+60	mT
Linearity Error	NL	B in range Bop Vout in [10%Vdd, 90%Vdd]	-0.7		+0.7	%FS
Hysteresis	Br	B = Bop	-50		+50	uT
Programmable Sensitivity	S	CAV-000 CAV-001	30 30	40 60	200 200	mV/mT mV/mT
Sensitivity programming Resolution	Sres			0.1		%

Table 6: Magnetic specification for 60mT version (very high field)

(1) Outside Bop, the IMC progressively enters saturation, yielding to an increase of the linearity error.

8 Analog output specification

8.1 Timing specification

Operating Parameters $T_A = -40^{\circ}\text{C}$ to 125°C , $V_{dd} = 4.5\text{V}$ to 5.5V (unless otherwise specified).

Parameter	Symbol	Test Conditions / Comments	Min	Typ	Max	Units
Refresh rate	T_{rr}		0.8	1	2	μs
Step Response Time	T_{resp}	Delay between the input signal reaching 90% and the output signal reaching 90%, (2V step at the output, input rise time = $1\mu\text{s}$) -Noise filter OFF -Noise filter ON		3 5	4 6	μs μs
Bandwidth	BW	-Noise filter OFF -Noise filter ON	200 120	250 150	300 180	kHz kHz
Power on Delay	T_{POD}	$V_{out} = 100\%$ of FS Pull-down resistor $\leq 100\text{k}\Omega$ During the Power-on delay, the output will remain within the 10% fault band at all time.			1	ms
Ratiometry Cut-off Frequency	F_{ratio}			250		Hz

Table 7: Timing specification for high speed analog output

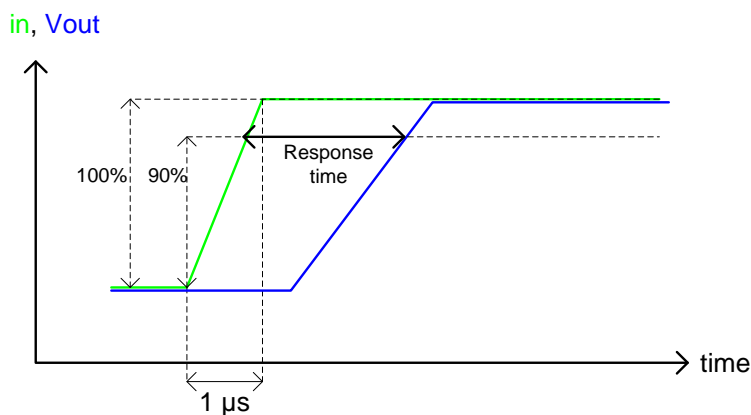

Figure 4: Response time definition

8.2 Accuracy specification

Operating Parameters $T_A = -40^{\circ}\text{C}$ to 125°C , $V_{dd} = 4.5\text{V}$ to 5.5V (unless otherwise specified).

Parameter	Symbol	Test Conditions	Min	Typ	Max	Units
Thermal Offset Drift	$\Delta^T\text{Voq}$	Offset drift referred to 25°C $S=40\text{mV/mT}$ (xxV version) $S=100\text{mV/mT}$ (xxH version) $S=250\text{mV/mT}$ (xxL version) $V_{dd}=5\text{V}$ $\text{TC}=0\pm 150\text{ppm}/^{\circ}\text{C}$ $\text{Voq}=50\pm 0.2\%V_{dd}$	-10		+10	mV
Thermal Offset Drift Resolution	$\Delta^T\text{VoqRes}$			0.075		mV/ $^{\circ}\text{C}$
Thermal Sensitivity Drift	TC		-1.5	0	+1.5	% of S
Thermal Sensitivity Drift Resolution	TCres			40		ppm/ $^{\circ}\text{C}$
RMS Output noise	N_{rms}	$S=40\text{mV/mT}$ (xxV version) $S=100\text{mV/mT}$ (xxH version) $S=250\text{mV/mT}$ (xxL version) -Noise filter OFF -Noise filter ON			0.2 0.12	%V _{dd} %V _{dd}
Ratiometry Error Offset	ΔVoq	$\text{Voq} = 50\%V_{dd}$ $\Delta V_{dd} = 10\%V_{dd}$	-0.4		+0.4	% of Voq
Ratiometry Error Sensitivity	ΔS	$\Delta V_{dd} = 10\%V_{dd}$	-0.4		+0.4	% of S

Table 8: Accuracy-Specific Parameters

8.3 Remarks to the achievable accuracy

The achievable target accuracy depends on the user end of line calibration. The resolution for the offset and offset drift calibration is better than $0.1\%V_{dd}$. Trimming capability is higher than measurement accuracy. End user calibration can increase the accuracy of the system.

9 Programmable items

9.1 Parameter table

Parameter	Bits	Comment
VOQ[11:0]	12	Quiescent output level (0 Gauss) adjustment
RG[2:0]	3	Rough gain adjustment
FG[9:0]	10	Fine gain adjustment
ENRATIO	1	Ratiometry enablement
TC1[7:0]	8	Adjustment of the first order temperature compensation of the magnetic sensitivity
TC2HOT[4:0]	5	Adjustment of the extra temperature compensation of the magnetic sensitivity at high temperature
TC2COLD[4:0]	5	Adjustment of the extra temperature compensation of the magnetic sensitivity at low temperature
OFFDR2C[5:0]	6	Adjustment of the offset drift at low temperature after the VGA
OFFDR2H[5:0]	6	Adjustment of the offset drift at high temperature after the VGA
NOISEFILT	1	Noise filter enablement
CRC[15:0]	16	16-bit CRC for the checksum calculation of the configuration register.
ID[47:0]	48	Customer identification code

Table 9: Customer programmable items

9.2 Sensitivity programming (RG, FG)

The sensitivity can be programmed from 50 to 300mV/mT (high field version) or 100 to 700mV/mT (low field version), with the ROUGHGAIN (3 bits) and FINEGAIN (10 bits) parameters.

9.3 Offset / output quiescent voltage programming (VOQ)

The offset is programmable with 12 bits in 1.5 mV steps over the full output range. This corresponds to a calibration resolution of 0.03 %VDD.

The typical step size would be $5V/4096 = 1.22$ mV, but the actual step size can differ from the nominal value because of internal gain tolerance. A maximum step size of 1.5 mV is guaranteed.

Note: for optimal performance over temperature, the VOQ should be programmed in the range from 2 to 3V.

9.4 Output ratiometry (ENRATIO)

The ratiometry of the output versus the supply can be disabled by setting this bit to 0.

Note: for optimal performance over temperature, the ratiometry setting should not be changed on customer side. By default, this setting is enabled during final test calibration.

9.5 Sensitivity temperature drift programming (TC1ST, TC2ND_COLD, TC2ND_HOT)

First order sensitivity temperature drift can be trimmed with TC1. The programming resolution is 40ppm/K. Second order sensitivity temperature drift can be trimmed with TC2COLD and TC2HOT. The programming resolution is 2ppm/K² for TC2COLD and 0.6ppm/K² for TC2HOT. The second order can also be seen as third order correction since cold and hot sides are independently adjusted.

Note: for optimal performance over temperature, the first order sensitivity drift compensation (TC1ST) should not exceed ± 250 ppm/K.

9.6 Offset temperature drift programming (OFFDR2C, OFFDR2H)

Offset temperature drift caused by the output amplifier can be compensated with these two parameters. This first order correction is done independently for temperatures over and below 25°C.

Note: Two additional parameters (OFFDR1C, OFFDR1H) are calibrated by Melexis to compensate for the offset temperature drift caused by the Hall element (before the variable gain amplifier). These parameters should not be adjusted on customer-side.

9.7 Noise filter (NOISEFILT)

Setting this bit to 1 enables the noise filter, reducing noise and increasing response time.

9.8 Identification code (ID)

48 bits programmable identification code.

10 Self diagnostic

The MLX91208 provides self diagnostic features to detect internal memory errors and over- / under-voltage. Those features increase the robustness of the IC functionality, as they prevent the IC from providing erroneous output signal in case of internal or external failure modes.

Error	Action	Effect on Outputs	Remarks
Calibration Data CRC Error (at power up and in normal working mode)	Faultmode	High Impedance mode	Pull down resistive load => Diag Low Pull up resistive load => Diag High
Power On delay		High Impedance mode	5ms max in high impedance followed by settling
Undervoltage Mode	IC is reset	High Impedance mode	300mV Hysteresis (typical)
Overvoltage detection	IC is reset	High Impedance mode	100mV Hysteresis (typical)

Table 10: Self diagnostic

11 Application information

Please refer to our current sensor reference design guide for more application information:
<http://melexis.com/Assets/Current-Sensors-Reference-Designs-6187.aspx>

11.1 Low current measurement $\pm 2-10A$

Low currents can be measured by either using a multi-turn/multi-layer PCB where the current is allowed to flow several times under the sensor, or by adding a closed ferromagnetic shield around the current trace with a small air gap to concentrate the magnetic flux above the sensor.

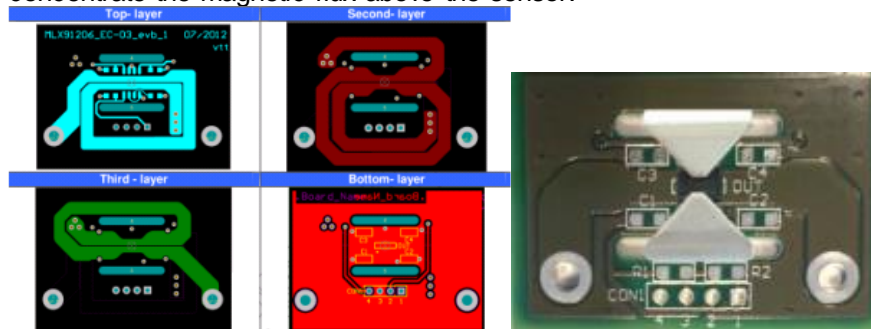

Figure 3: Low current applications with either multi-trace/multi-layer PCB (left) or closed shield (right).

11.2 Medium current measurement up to $\pm 50A$

For medium currents, a single PCB trace can be used. The sizing of the PCB trace should take into account the current handling capability and the total power dissipation. The PCB trace should be thick and wide enough to handle the RMS current continuously.

A simple “U-shaped” ferromagnetic shield is often required to protect the sensor from cross-talk or external stray fields, if they cannot be cancelled-out by other means (peak-peak detection, etc.).

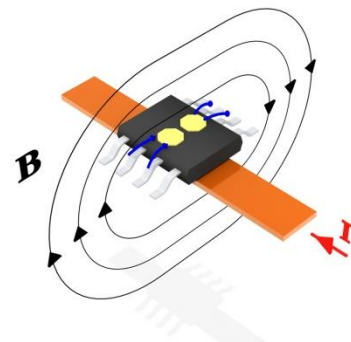

Figure 4: Medium current application on PCB

11.3 High current measurement up to $\pm 1000A$

For high currents flowing in a bus bar, MLX91208 is typically assembled on a PCB lying immediately above the current conductor.

A ferromagnetic shield is usually added to protect the sensor from external fields and ensure good homogeneity of the magnetic flux, for optimal robustness against vibrations and mechanical tolerances.

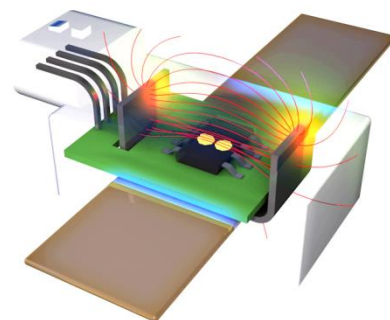

Figure 5: High current application on bus bar

12 Recommended Application Diagrams

12.1 Resistor and capacitor values

Part	Description	Value	Unit
C1	Supply capacitor, EMI, ESD	100	nF
C2	Decoupling, EMI, ESD	2-10 ⁽¹⁾	nF
C3	Decoupling, EMI, ESD	47	nF
R1	Pull up or pull down resistor	6-100	kΩ

Table 11: Resistor and capacitor values

(1) 10nF is recommended for better EMC and ESD performance.

12.2 Pull down resistor for diagnostic low

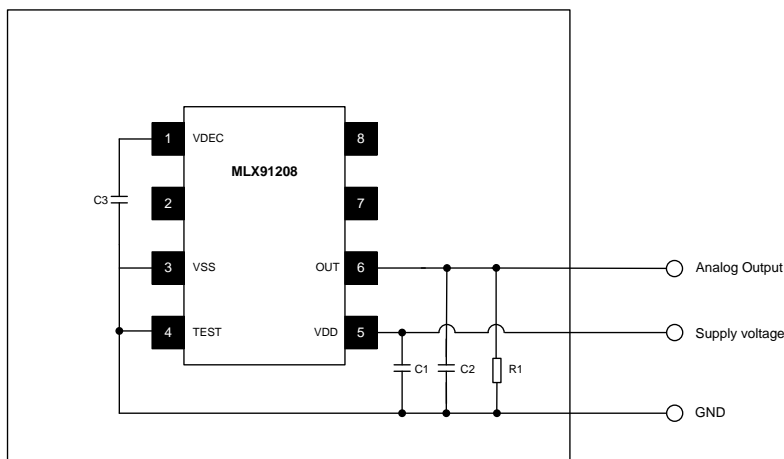

Figure 6: Diagnostic low

12.3 Pull up resistor for diagnostic high

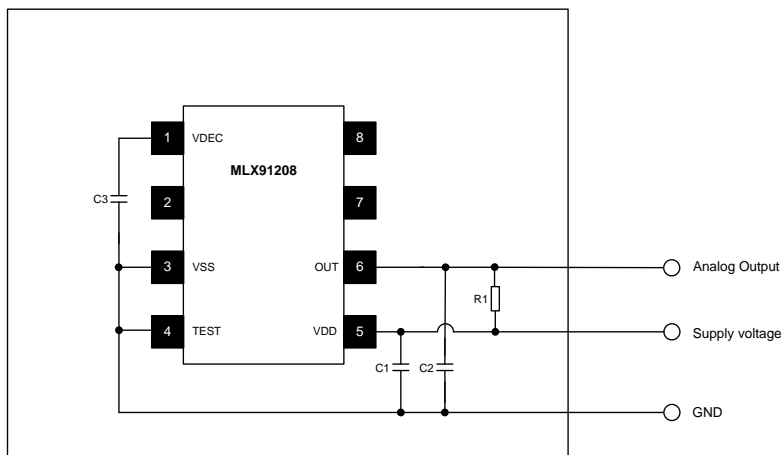

Figure 7: Diagnostic high

13 Typical performance

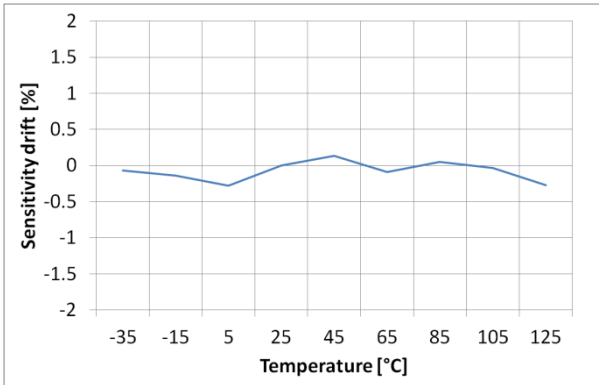

Figure 8: Thermal sensitivity drift.

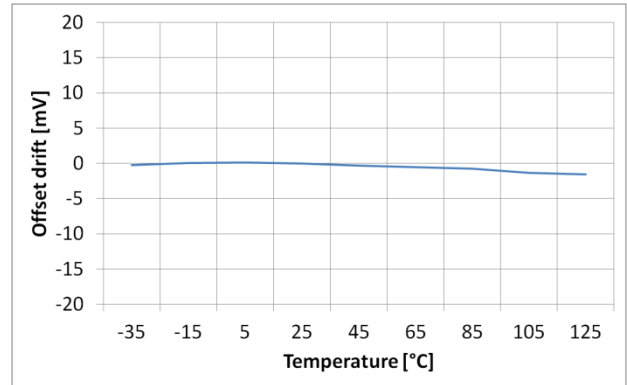

Figure 9: Thermal offset drift.

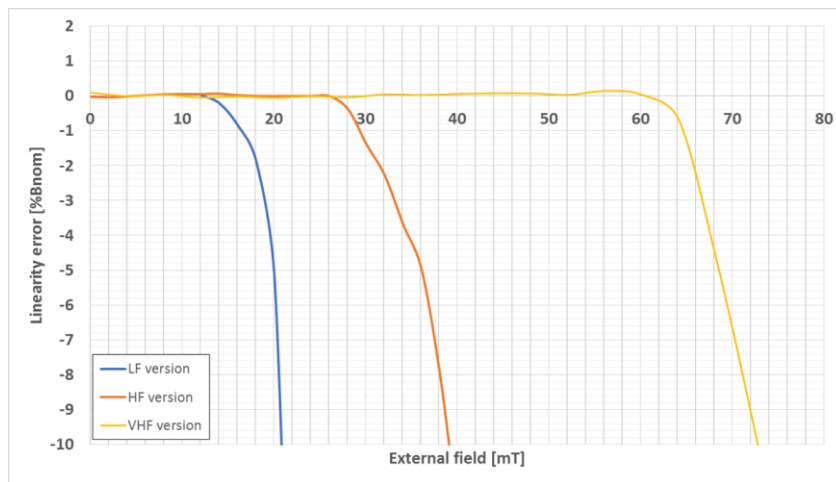

Figure 10: Linearity error for all versions.

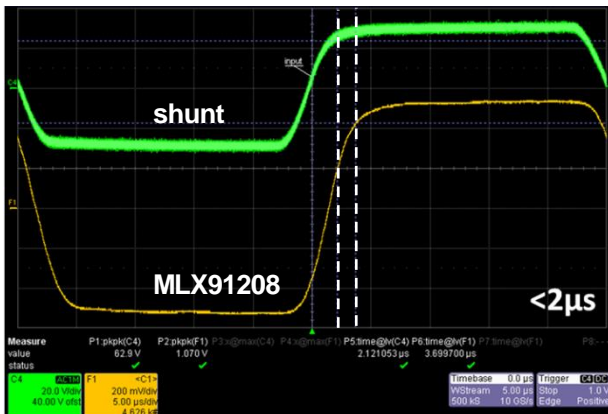

Figure 11: Response time with noise filter OFF.

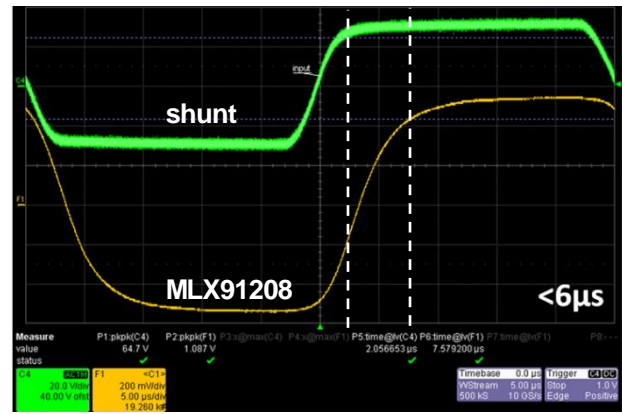

Figure 12: Response time with noise filter ON.

14 Standard information regarding manufacturability of Melexis products with different soldering processes

Melexis devices are qualified using state-of-the-art practices in accordance with automotive and environmental requirements.

Through qualifications, various soldering techniques are considered; please refer to “Soldering recommendations for Melexis products” for more information:

http://www.melexis.com/Asset/Soldering_Application_Note_and_Recommendations_DownloadLink_5446.aspx.

For components normally soldered using Surface Mounted Device techniques (eg: Reflow process), Melexis has defined and qualified Moisture Sensitivity Level and Peak Temperature in accordance with the Jedec J-STD-020 standard. Delivered material is conditioned accordingly. Moisture Sensitivity Level and Peak Temperature information can be found on the label identifying the material.

In case you intend to use a reflow soldering process for through hole devices (Melexis’ package codes: SA, UA, VA, VK, VM), please contact Melexis to verify your soldering process compatibility.

The application of Wave Soldering for SMD’s is allowed only after consulting Melexis regarding assurance of adhesive strength between device and board.

Based on Melexis commitment to environmental responsibility, Europe legislations (Direction on the Restriction of the Use of Certain Hazardous substances, RoHS) and customer requests, Melexis has deployed Pb free leadfinish (typically Matte Tin) on all ASSP products.

For through hole devices (Melexis’ package codes: SA, UA, VA, VK, VM) Trim&Form, please refer to “Trim & Form recommendations for Melexis products” for more information:

http://www.melexis.com/Assets/Trim_and_form_recommendations_DownloadLink_5565.aspx

15 ESD Precautions

Electronic semiconductor products are sensitive to Electro Static Discharge (ESD).

Always observe Electro Static Discharge control procedures whenever handling semiconductor products.

ESD HBM robustness is 2kV on external pins according to AEC-Q100-002 REV-D.

16 Package information

16.1 SOIC-8 Package Dimensions

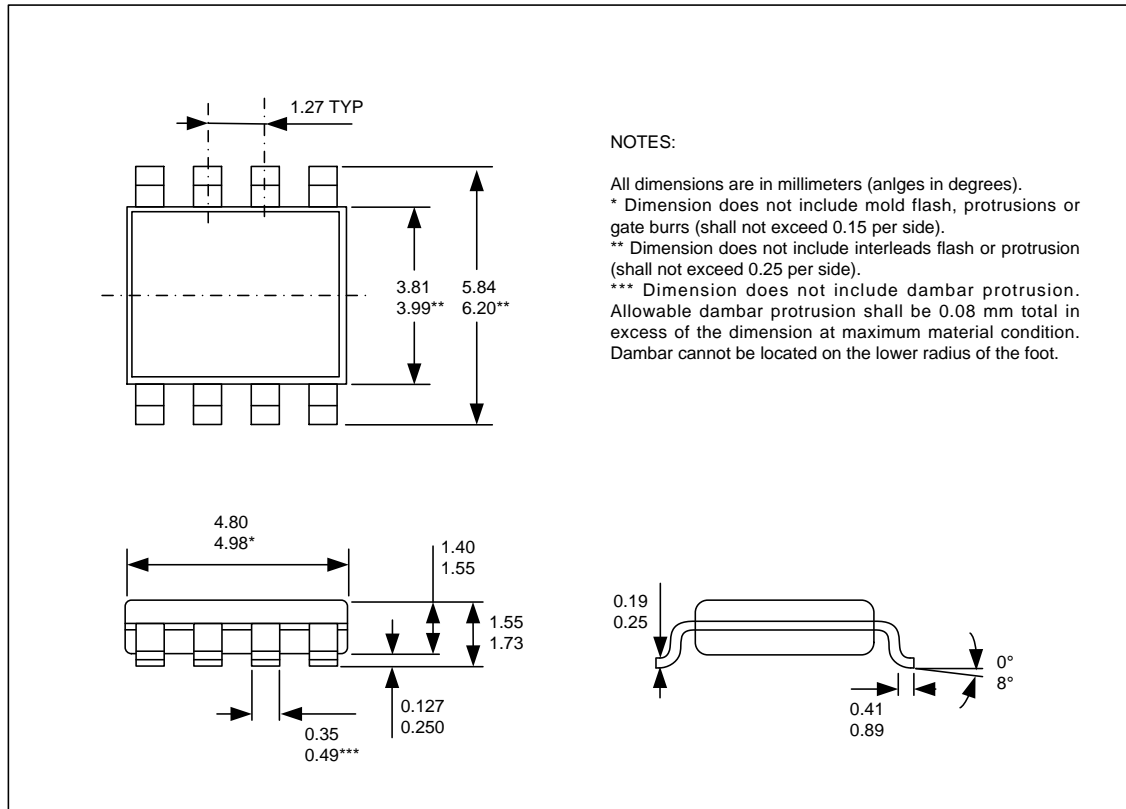

Figure 13: SOIC-8 Package dimensions

16.2 SOIC-8 Pinout and Marking

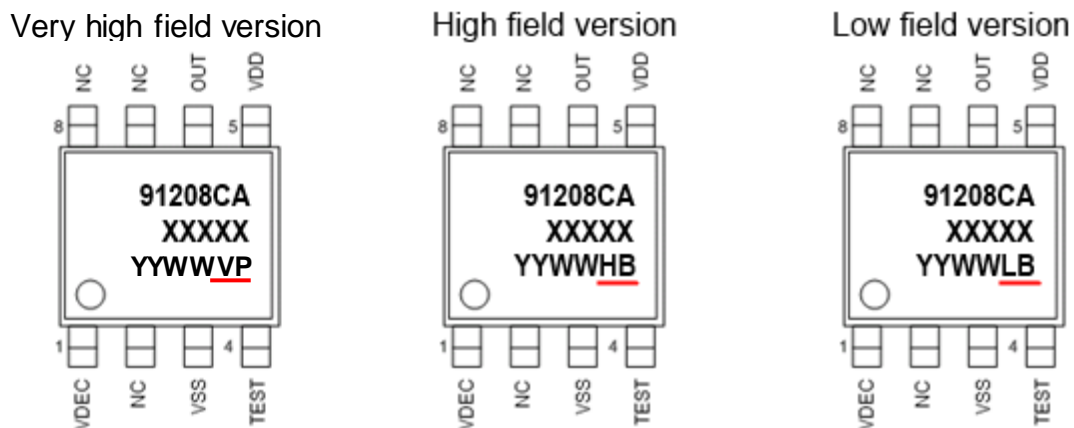

Figure 14: SOIC-8 Pinout and marking (Very High Field, High Field and Low Field version)

16.3 SOIC-8 Hall plate position

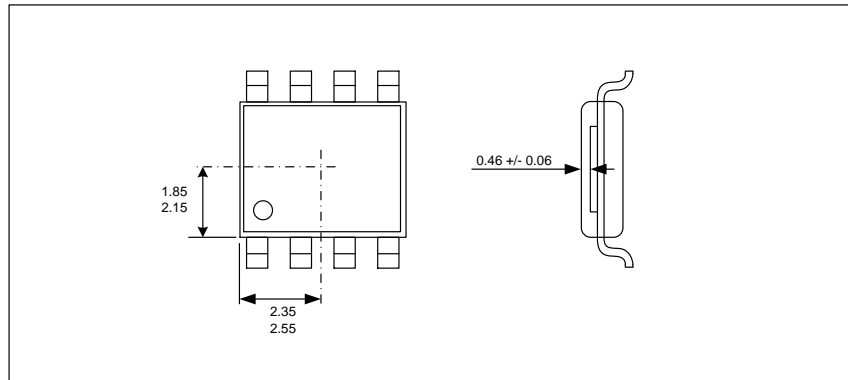

Figure 15: SOIC-8 Hall Plate positioning

16.4 SOIC-8 IMC Position and magnetic sensitive direction

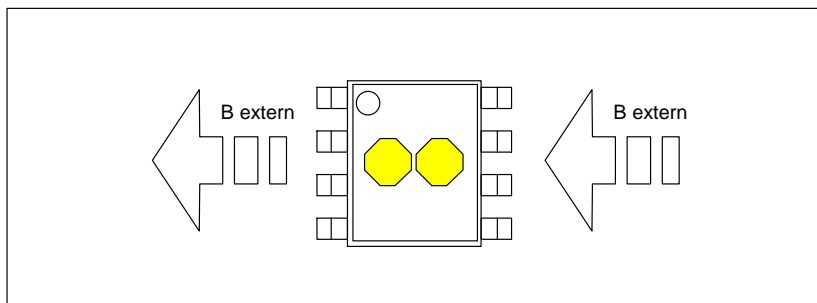

Figure 16: IMC position and geometry for low-field version

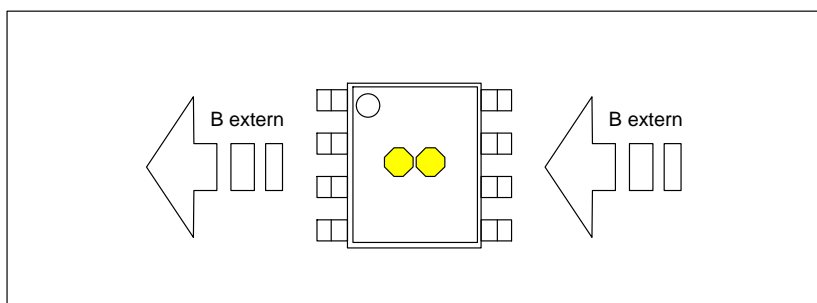

Figure 17: IMC position and geometry high-field version

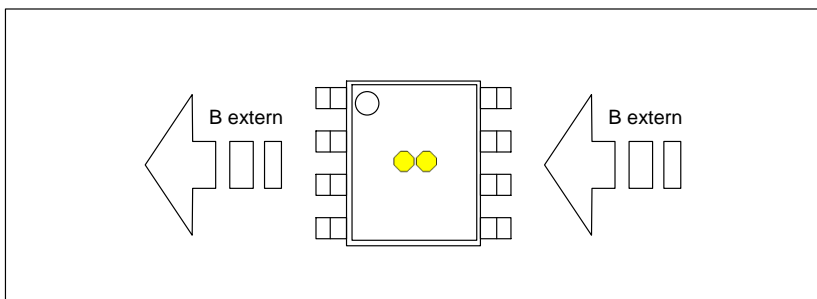

Figure 18: IMC position and geometry very high-field version

Disclaimer

Devices sold by Melexis are covered by the warranty and patent indemnification provisions appearing in its Term of Sale. Melexis makes no warranty, express, statutory, implied, or by description regarding the information set forth herein or regarding the freedom of the described devices from patent infringement. Melexis reserves the right to change specifications and prices at any time and without notice. Therefore, prior to designing this product into a system, it is necessary to check with Melexis for current information. This product is intended for use in normal commercial applications. Applications requiring extended temperature range, unusual environmental requirements, or high reliability applications, such as military, medical life-support or life-sustaining equipment are specifically not recommended without additional processing by Melexis for each application.

The information furnished by Melexis is believed to be correct and accurate. However, Melexis shall not be liable to recipient or any third party for any damages, including but not limited to personal injury, property damage, loss of profits, loss of use, interrupt of business or indirect, special incidental or consequential damages, of any kind, in connection with or arising out of the furnishing, performance or use of the technical data herein. No obligation or liability to recipient or any third party shall arise or flow out of Melexis' rendering of technical or other services.

© 2009 Melexis NV. All rights reserved.

For the latest version of this document, go to our website at
www.melexis.com

Or for additional information contact Melexis Direct:

Europe, Africa, Asia:	America:
Phone: +32 1367 0495	Phone: +1 603 223 2362
E-mail: sales_europe@melexis.com	E-mail: sales_usa@melexis.com

ISO/TS 16949 and ISO14001 Certified