

---

SURFACE MOUNT LED TAPE AND REEL



Lead-Free Parts

## LRGB9553/S27-J

# DATA SHEET

DOC. NO : QW0905-LRGB9553/S27-J

REV. : A

DATE : 17 - Sep. - 2012



### Features:

1. Top view white LED.
2. white SMT package.
3. Leadframe package with individual 4 pin.
4. Wide viewing angle.
5. Soldering methods: IR reflow soldering.
6. Feature of the device: more light due to higher optical efficiency; extremely wide viewing angle; ideal for backlighting and coupling in light guide.

### Descriptions:

The LRGB9553 SMD has wide viewing angle and optimized light coupling by inter reflector, The low current requirement makes this device ideal for portable equipment or any other application where power is at a premium.

### Applications:

1. LCD back light.
2. Mobile phones.
3. Indicators.
4. Switch lights.
5. Lighting.

### Device Selection Guide:

PART NO	MATERIAL	COLOR	
		Emitted	Lens
LRGB9553/S27-J	AlGaInP	Red	Water Clear
	InGaN/GaN	Green	
	InGaN/GaN	Blue	

## Package Dimensions

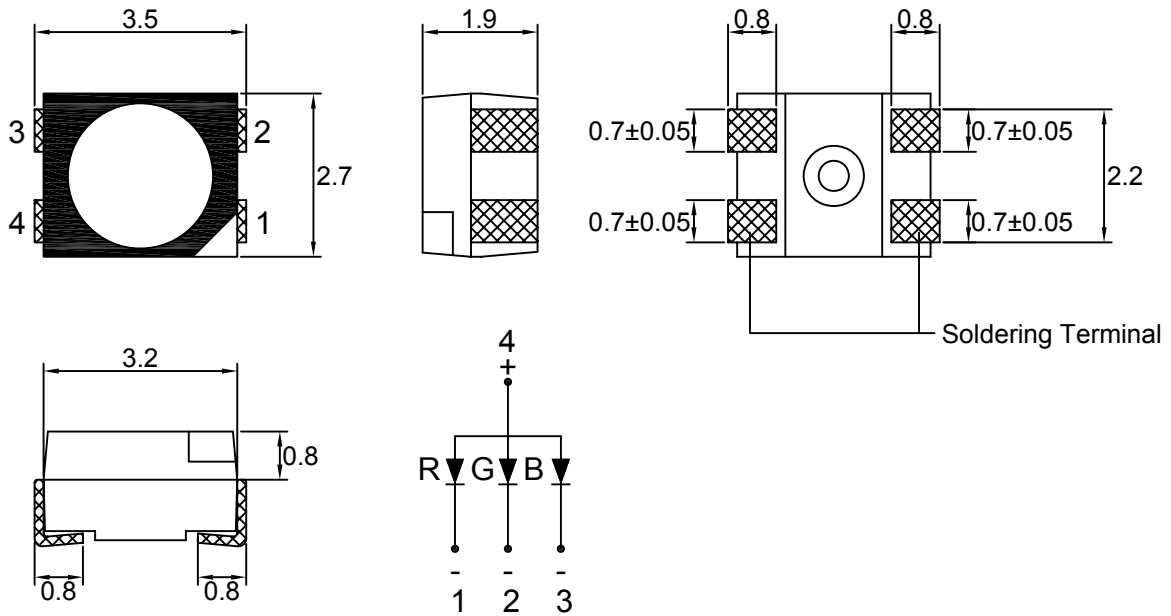

Note : 1.All dimension are in millimeter tolerance is  $\pm 0.2\text{mm}$  unless otherwise noted.  
2.Specifications are subject to change without notice.

## Recommended Soldering Pad Dimensions

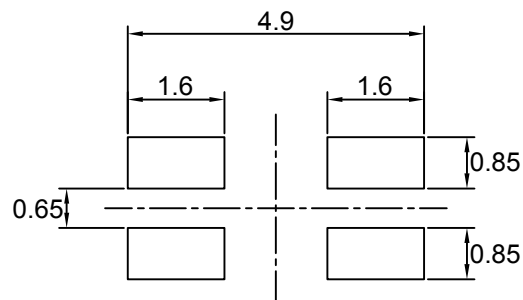

Note : The tolerances unless mentioned is  $\pm 0.1\text{mm}$ , Unit=mm.

### Absolute Maximum Ratings at Ta=25°C

Parameter	Symbol	Ratings			UNIT
		UEL	DGM	DBK	
Forward Current	IF	50	30	30	mA
Peak Forward Current Duty 1/10@10KHz	IFP	90	100	100	mA
Power Dissipation	PD	120	120	120	mW
Reverse Current @5V	Ir	10	50	50	μA
Electrostatic Discharge	ESD	2000			V
Operating Temperature	Topr	- 20 ~ + 80			°C
Storage Temperature	Tstg	- 30 ~ + 100			°C

### Typical Electrical & Optical Characteristics (Ta=25°C)

Items	Symbol	Min.	Typ.	Max.	UNIT	CONDITION	
Luminous Intensity	Iv	UEL	125	250	----	mcd	IF=20mA
		DGM	200	450	----		
		DBK	50	100	----		
Dominant Wavelength	λD	UEL	----	624	----	nm	IF=20mA
		DGM	----	525	----		
		DBK	----	470	----		
Spectral Line Half-Width	Δλ	UEL	----	20	----	nm	IF=20mA
		DGM	----	36	----		
		DBK	----	30	----		
Forward Voltage	VF	UEL	1.7	----	2.6	V	IF=20mA
		DGM	2.8	----	3.6		
		DBK	2.8	----	3.6		
Viewing Angle	2θ 1/2	UEL	----	120	----	deg	IF=20mA
		DGM	----	120	----		
		DBK	----	120	----		

Note : 1.The forward voltage data did not including ±0.1V testing tolerance.  
2.The luminous intensity data did not including ±15% testing tolerance.

### Luminous Intensity Classification

BIN CODE		lv(mcd) at 20mA	
		Min.	Max.
UEL	R	125	200
	S	200	320
	T	320	500
	U	500	800

BIN CODE		lv(mcd) at 20mA	
		Min.	Max.
DGM	S	200	320
	T	320	500
	U	500	800
	V-1	800	1000

BIN CODE		lv(mcd) at 20mA	
		Min.	Max.
DBK	P	50	80
	Q	80	125
	R	125	200
	S	200	320

## Typical Electro-Optical Characteristics Curve UEL CHIP

Fig.1 Forward current vs. Forward Voltage

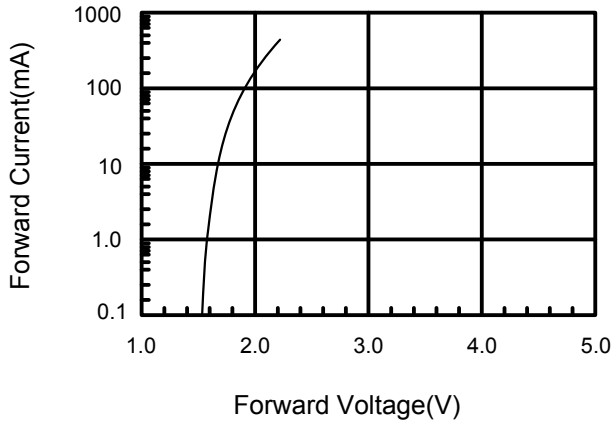

Fig.2 Relative Intensity vs. Forward Current

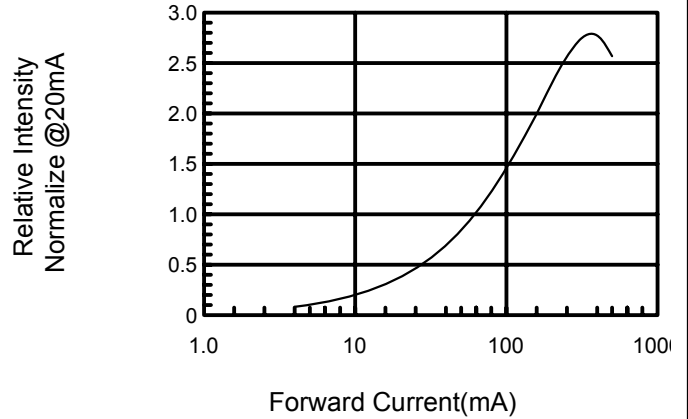

Fig.3 Forward Voltage vs. Temperature

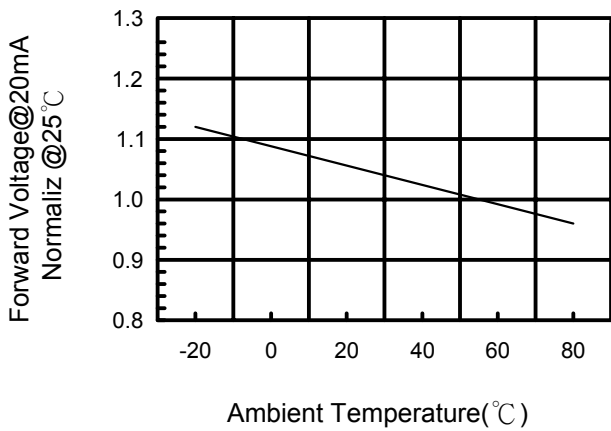

Fig.4 Relative Intensity vs. Temperature

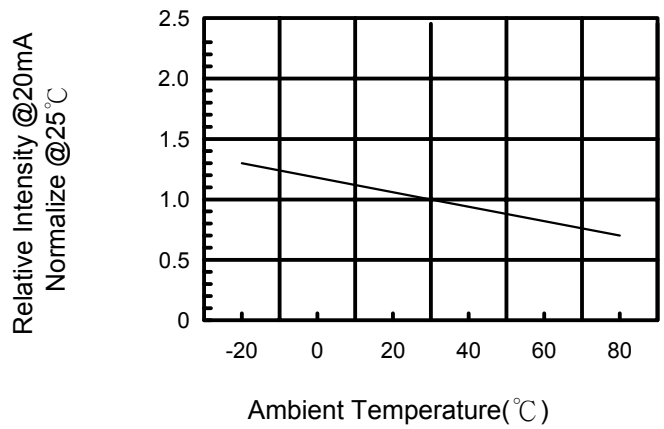

Fig.5 Relative Intensity vs. Wavelength

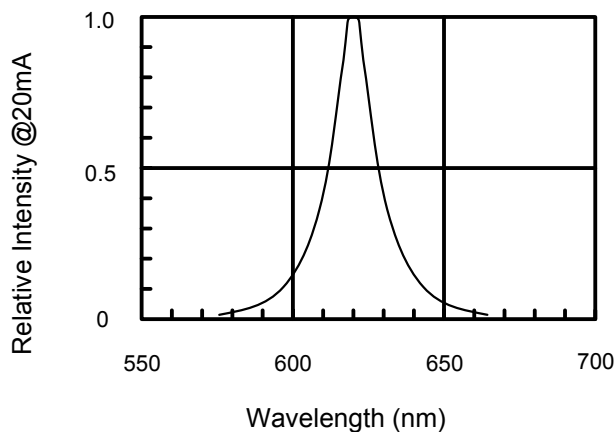
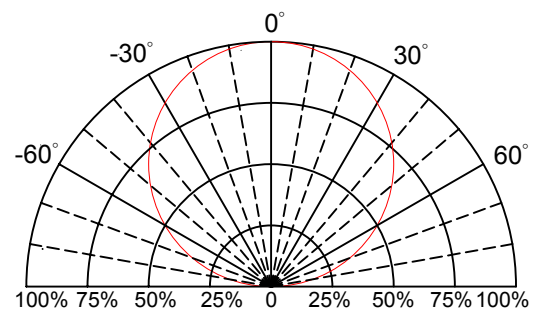

Fig.6 Directive Radiation



### Typical Electro-Optical Characteristics Curve

DGM CHIP

Fig.1 Forward current vs. Forward Voltage

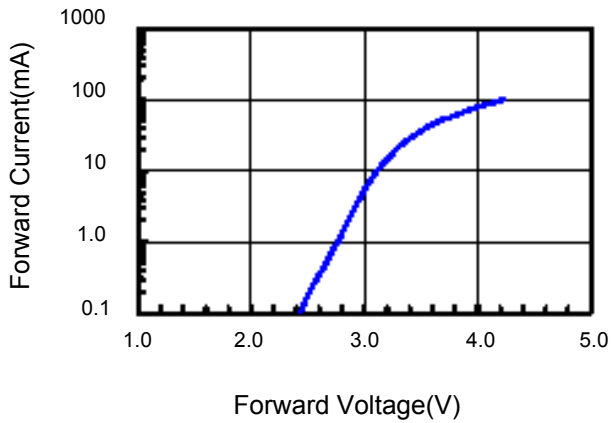

Fig.2 Relative Intensity vs. Forward Current

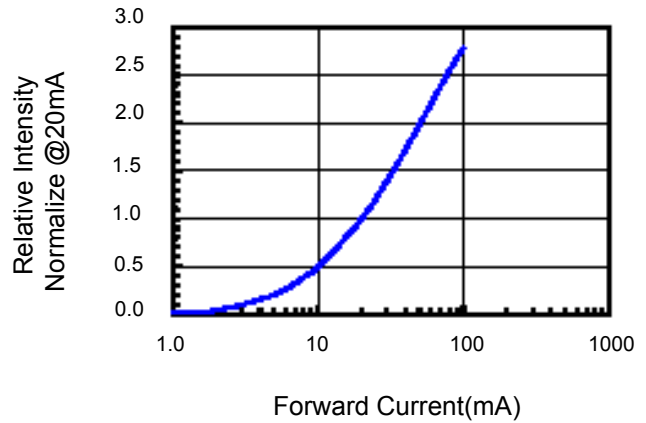

Fig.3 Forward Voltage vs. Temperature

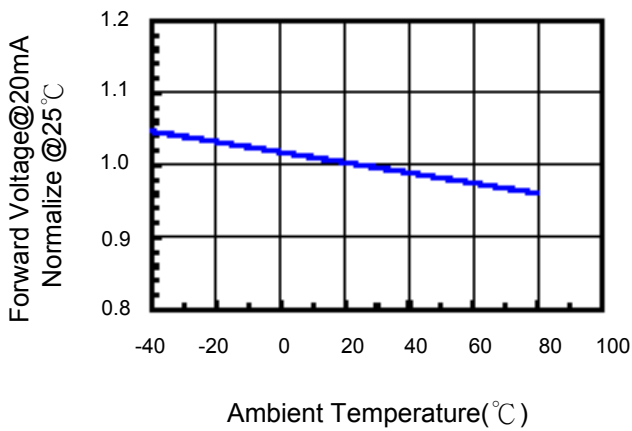

Fig.4 Relative Intensity vs. Temperature

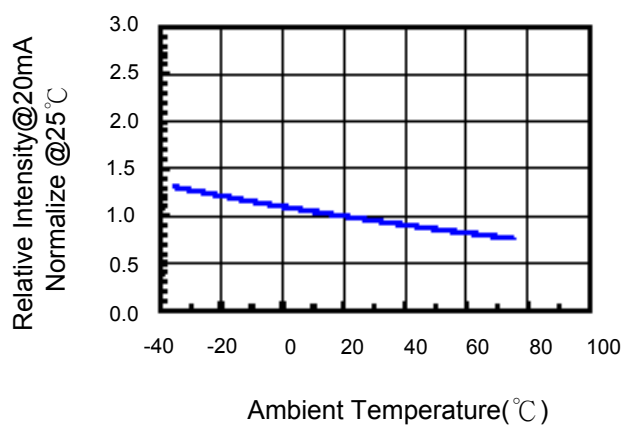

Fig.5 Relative Intensity vs. Wavelength

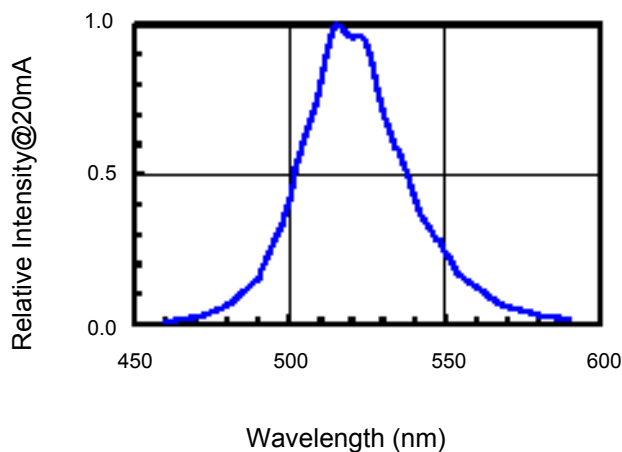
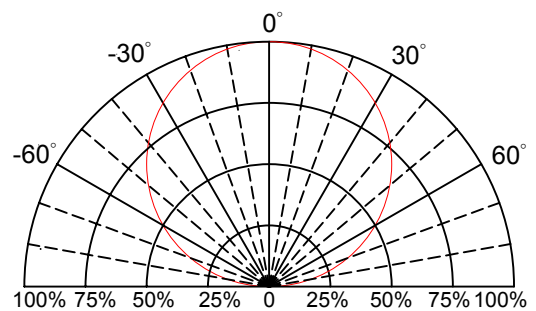

Fig.6 Directive Radiation



## Typical Electro-Optical Characteristics Curve

DBK CHIP

Fig.1 Forward current vs. Forward Voltage

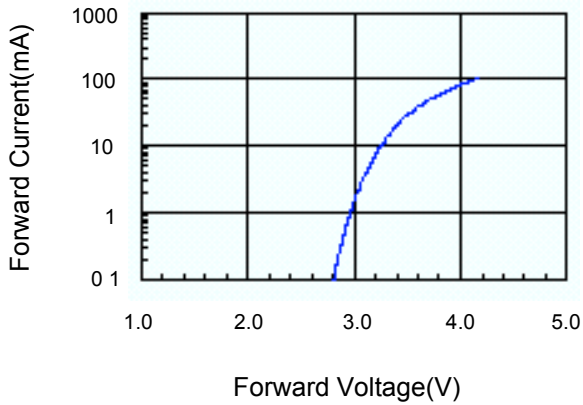

Fig.2 Relative Intensity vs. Forward Current

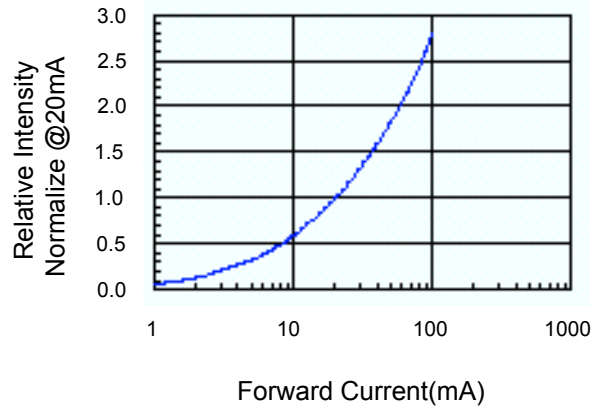

Fig.3 Forward Voltage vs. Temperature

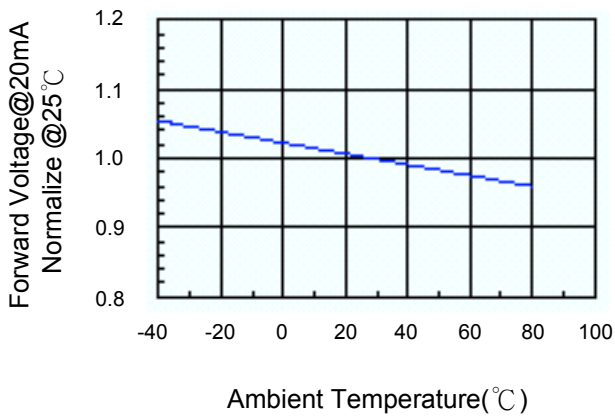

Fig.4 Relative Intensity vs. Temperature

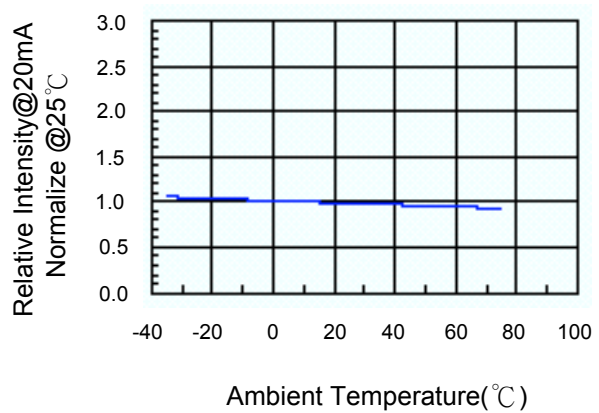

Fig.5 Relative Intensity vs. Wavelength

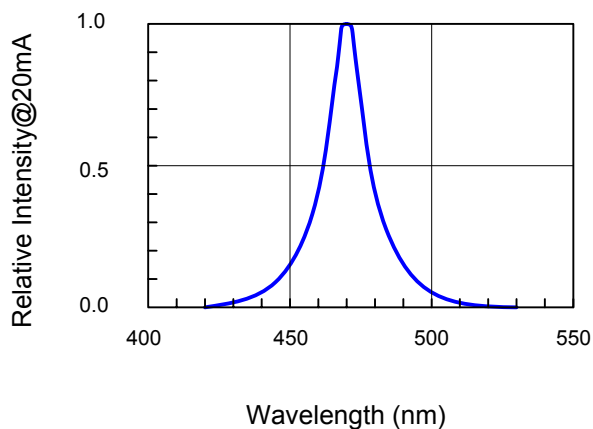
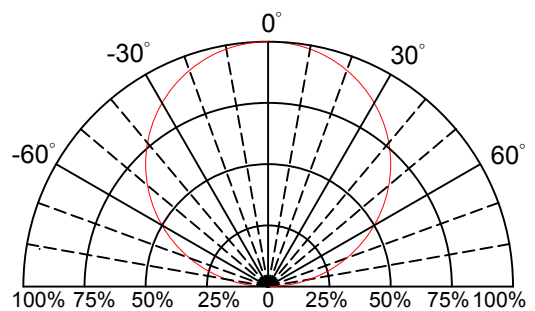
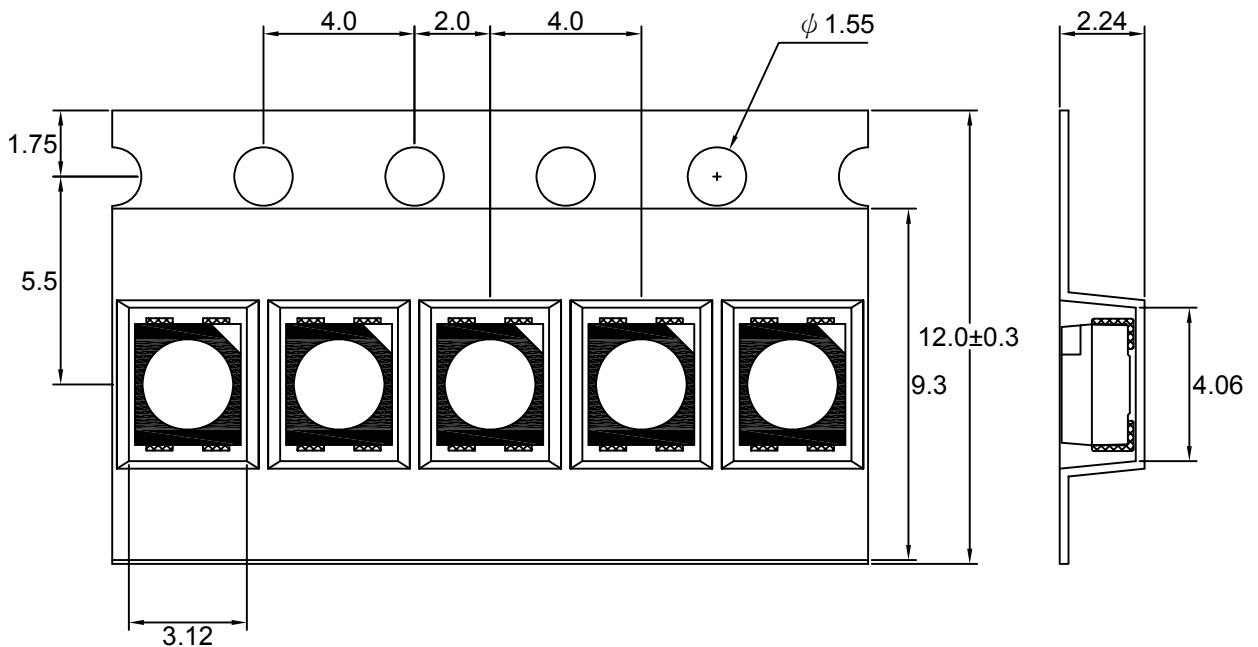

Fig.6 Directive Radiation





### Carrier Type Dimensions







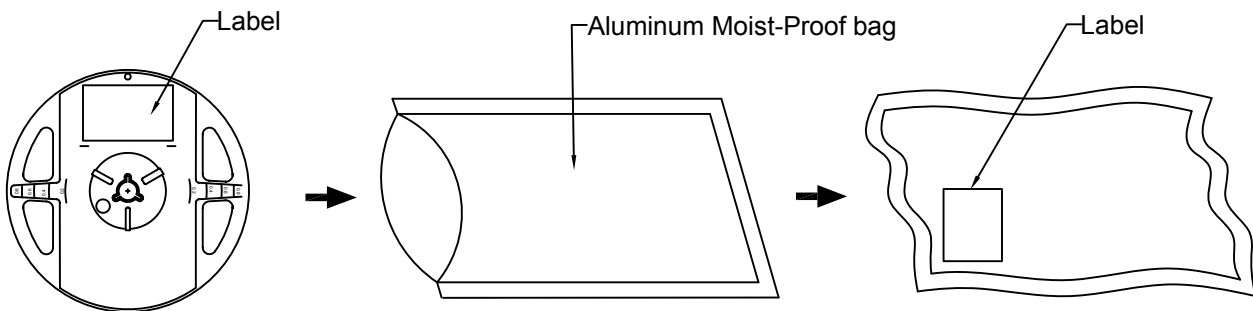



Note : The tolerances unless mentioned is  $\pm 0.1$ mm, Angle  $\pm 0.5$ . Unit=mm.

### • Packing Specifications



Part No.	Description	Quantity/Reel
LRGB9553/S27-J	12.0mm tape, 7" reel	1500 PCS

## Label Explanation

	LIGITEK ELECTRONICS CO., LTD.	
		
	PART :	LRGB9553/S27-J
		
	LOT :	GS1-070142
		
QTY(PCS):	1500	VF:1.7-2.6
		
BIN/HUE :	R/S/P	VF:2.8-3.6
		
		VF:2.8-3.6

BIN : Luminous Intensity

VF : Forward Voltage

## Reel Dimensions

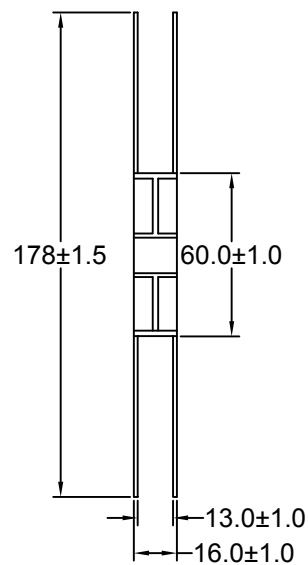
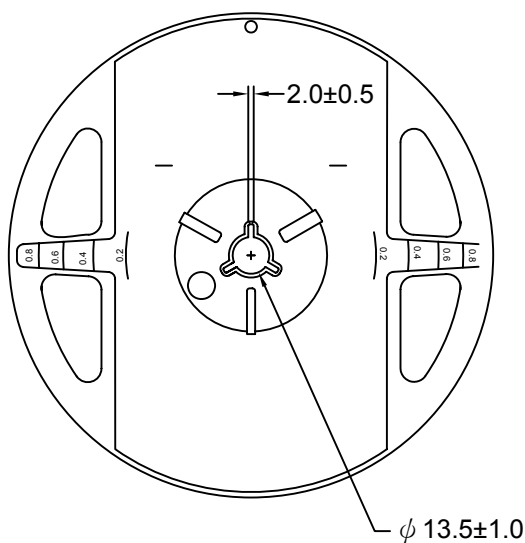

## Box Explanation

1. 4 BAG / INNER BOX

2. INNER BOX SIZE : L X W X H 23cm X 8.5cm x 26cm

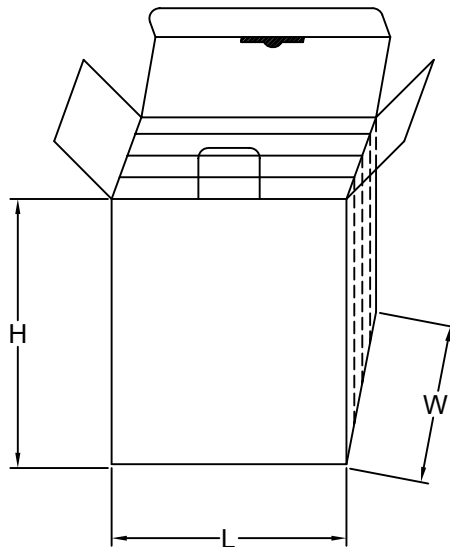

3. 10 INNER BOXES / CARTON

4. CARTON SIZE : L X W X H 58cm X 34cm x 35cm

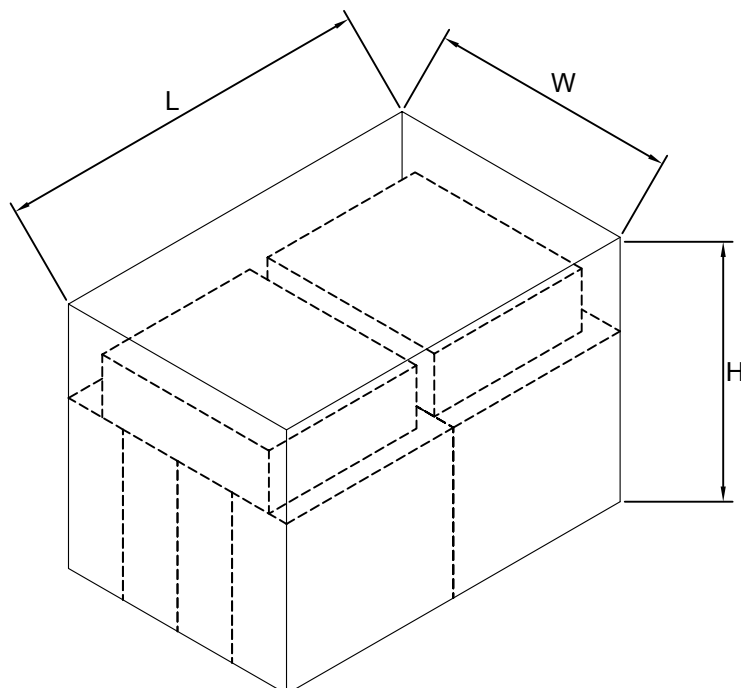

## Recommended Soldering Conditions

### 1. Hand Solder

Basic spec is  $\leq 320^{\circ}\text{C}$  3 sec one time only.

### 2. Wave Solder

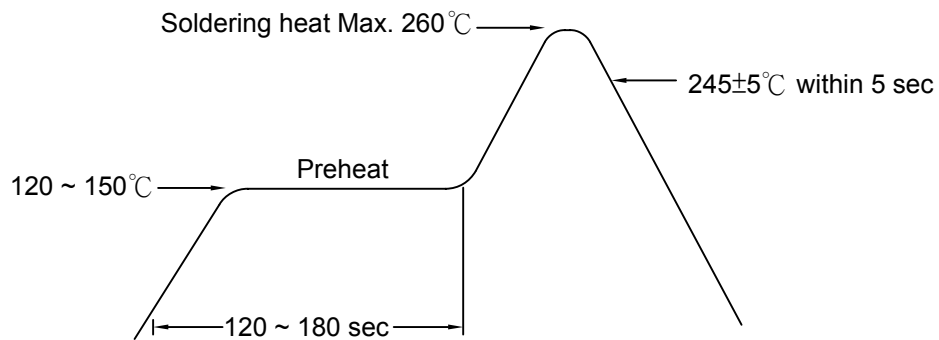

### 3. PB-Free Reflow Solder

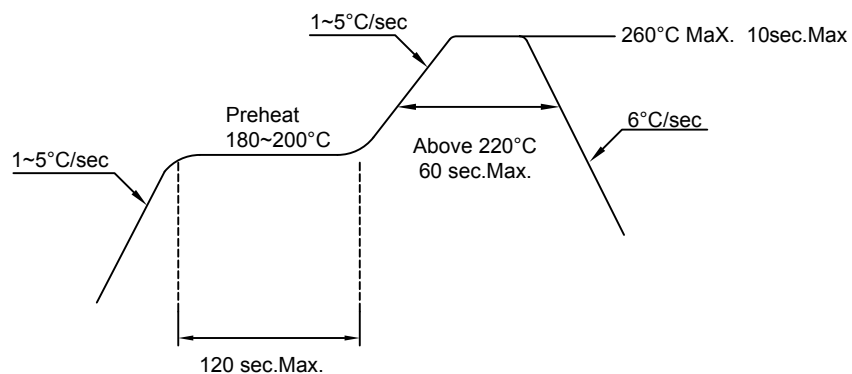

#### Note:

- 1.Reflow soldering should not be done more than two times.
- 2.When soldering,do not put stress on the LEDs UELing heating.
- 3.After soldering,do not warp the circuit board.

**Precautions For Use:****Storage time:**

- 1.The operation of Temperatures and RH are :  $5^{\circ}\text{C}\sim 35^{\circ}\text{C}$  ,RH60%.
- 2.Once the package is opened, the products should be used within a week.  
Otherwise, they should be kept in a damp proof box with desiccating agent.  
Considering the tape life, we suggest our customers to use our products within a year(from production date).
- 3.If opened more than one week in an atmosphere  $5^{\circ}\text{C} \sim 35^{\circ}\text{C}$  ,RH60%, they should be treated at  $60^{\circ}\text{C}\pm 5^{\circ}\text{C}$  for 15hrs.

**Drive Method:**

LED is a current operated device, and therefore, requires some kind of current limiting incorporated into the driver circuit. This current limiting typically takes the form of a current limiting resistor placed in series with the LED.

Consider worst case voltage variations that could occur across the current limiting resistor. The forward current should not be allowed to change by more than 40% of its desired value.

Circuit model A

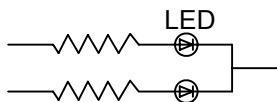

Circuit model B

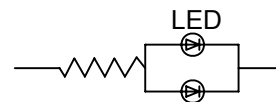

(A) Recommended circuit.

(B) The difference of brightness between LED could be found due to the VF-IF characteristics of LED.

**Cleaning:**

Use alcohol-based cleaning solvents such as isopropyl alcohol to clean the LED.

**ESD(Electrostatic Discharge):**

Static Electricity or power surge will damage the LED. Use of a conductive wrist band or anti-electrostatic glove is recommended when handling these LED. All devices, equipment and machinery must be properly grounded.

**Reliability Test:**

(1) Test items and results

Classification	Test Item	Test Condition	Sample Size
EnUELance Test	Operating Life Test	1.Ta=Under Room Temperature As Per Data Sheet Maximum Rating. 2.If=20mA 3.t=1000 hrs	22
	High Temperature Storage Test	1.Ta=105°C±5°C 2.t=500 hrs	22
	Low Temperature Storage Test	1.Ta=-40°C±5°C 2.t=1000 hrs	22
	High Temperature High Humidity Storage Test	1.IR-Reflow In-Board, 2 Times 2.Ta=85°C±5°C 3.RH=90%~95% 4.t=500hrs±2hrs	22
Environmental Test	Thermal Shock Test	1.IR-Reflow In-Board,2 times 2.Ta=105°C ±5°C & -40°C±5°C (30min) (30min) 3.total 100 cycles	22
	Reflow Soldering Test	1.T.Sol=260°C±5°C 2.Dwell Time= 10Max.	22
	Temperature Cycling	1.105°C ~ 25°C ~ -40°C 30mins 15mins 30mins 2.100 Cyeles	22

(2) Criteria for judging the damage

Item	Symbol	Test Conditions	Criteria for Judgement	
			Min.	Max.
Forward Voltage	Vf	If=20mA	-	U.S.L x1.2
Reverse Current	Ir	Vr=5V	-	U.S.L x2.0
Luminous Intensity	Iv	If=20mA	L.S.L x 0.5	-

**Note:**

1.U.S.L.:Upper Standard Level.

2.L.S.L.:Lower Standard Level.