

SURFACE MOUNT LED TAPE AND REEL



Lead-Free Parts

LRGB9553/S32

DATA SHEET

DOC. NO : QW0905-LRGB9553/S32

REV. : A

DATE : 08 - Aug. - 2016



Features:

1. Top view white LED.
2. white SMT package.
3. Leadframe package with individual 4 pin.
4. Wide viewing angle.
5. Soldering methods: IR reflow soldering.
6. Feature of the device: more light due to higher optical efficiency; extremely wide viewing angle; ideal for backlighting and coupling in light guide.

Descriptions:

The LRGB9553 SMD has wide viewing angle and optimized light coupling by inter reflector, The low current requirement makes this device ideal for portable equipment or any other application where power is at a premium.

Applications:

1. LCD back light.
2. Mobile phones.
3. Indicators.
4. Switch lights.
5. Lighting.

Device Selection Guide:

PART NO	MATERIAL	COLOR	
		Emitted	Lens
LRGB9553/S32	AlGaInP	Red	Water Clear
	InGaN	Green	
	InGaN	Blue	

Package Dimensions

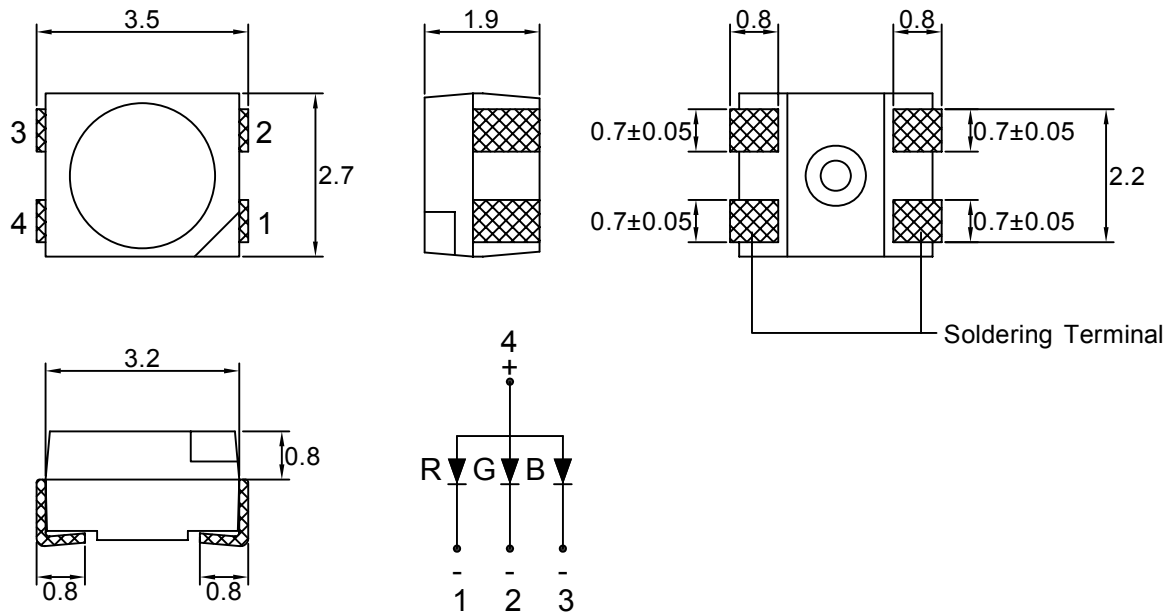

Note : 1.All dimension are in millimeter tolerance is ± 0.2 mm unless otherwise noted.
2.Specifications are subject to change without notice.

Recommended Soldering Pad Dimensions

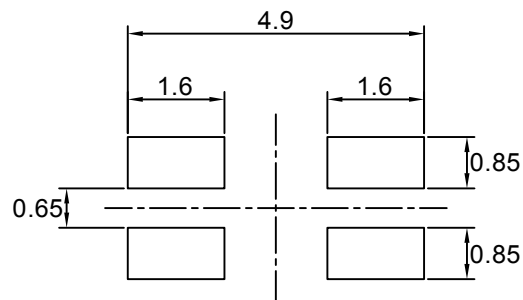

Note : The tolerances unless mentioned is ± 0.1 mm, Unit=mm.

Absolute Maximum Ratings at Ta=25°C

Parameter	Symbol	Ratings			UNIT
		R	G	B	
Forward Current	IF	30	30	30	mA
Peak Forward Current Duty 1/10@10KHz	IFP	90	100	100	mA
Power Dissipation	PD	72	108	108	mW
Reverse Current @5V	Ir	10	50	50	μA
Electrostatic Discharge	ESD	2000	500	500	V
Operating Temperature	Topr	-40 ~ + 85			°C
Storage Temperature	Tstg	-40 ~ + 100			°C

Typical Electrical & Optical Characteristics (Ta=25°C)

Items	Symbol	Min.	Typ.	Max.	UNIT	CONDITION	
Luminous Intensity	Iv	R	125	---	320	mcd	IF=20mA
		G	320	---	800		
		B	125	---	320		
Dominant Wavelength	λD	R	---	630	---	nm	IF=20mA
		G	---	525	---		
		B	---	470	---		
Spectral Line Half-Width	Δλ	R	---	20	---	nm	IF=20mA
		G	---	36	---		
		B	---	30	---		
Forward Voltage	VF	R	1.5	---	2.4	V	IF=20mA
		G	2.8	---	3.6		
		B	2.8	---	3.6		
Viewing Angle	2θ 1/2	R	---	120	---	deg	IF=20mA
		G	---	120	---		
		B	---	120	---		

Note : 1.The forward voltage data did not including ±0.1V testing tolerance.
 2.The luminous intensity data did not including ±15% testing tolerance.
 3.The color coordinates measurement allowance is ±0.01 testing tolerance.

Luminous Intensity Classification

BIN CODE		lv(mcd) at 20mA	
		Min.	Max.
R	R	125	200
	S	200	320

BIN CODE		lv(mcd) at 20mA	
		Min.	Max.
G	T	320	500
	U	500	800

BIN CODE		lv(mcd) at 20mA	
		Min.	Max.
B	R	125	200
	S	200	320

Typical Electro-Optical Characteristics Curve

HRF CHIP

Fig.1 Forward current vs. Forward Voltage

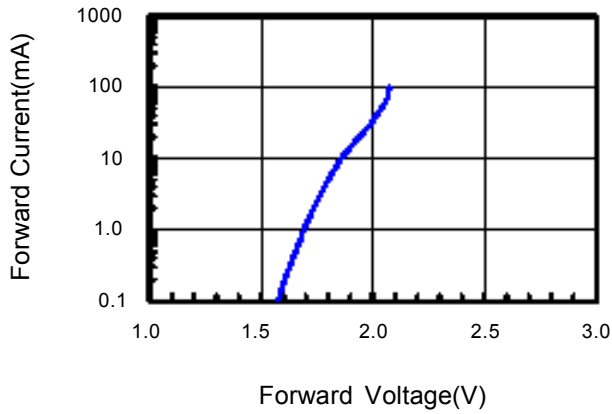

Fig.2 Relative Intensity vs. Forward Current

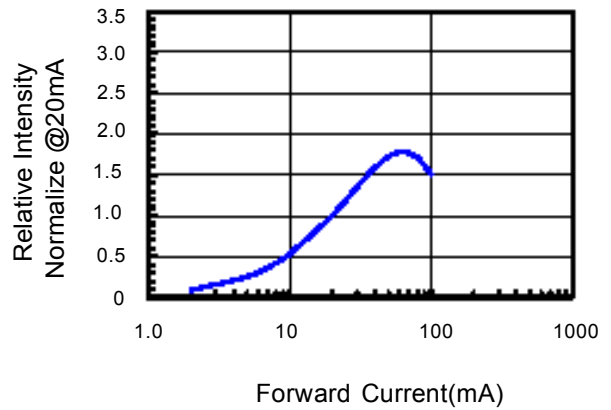

Fig.3 Forward Voltage vs. Temperature

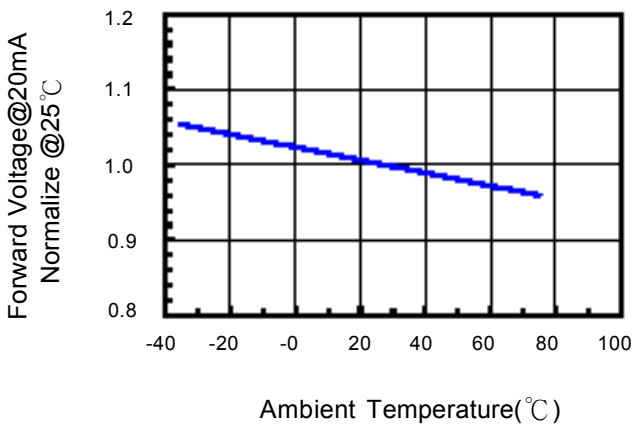

Fig.4 Relative Intensity vs. Temperature

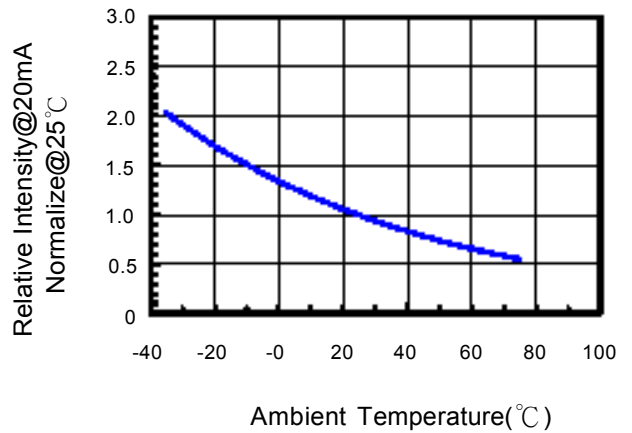

Fig.5 Relative Intensity vs. Wavelength

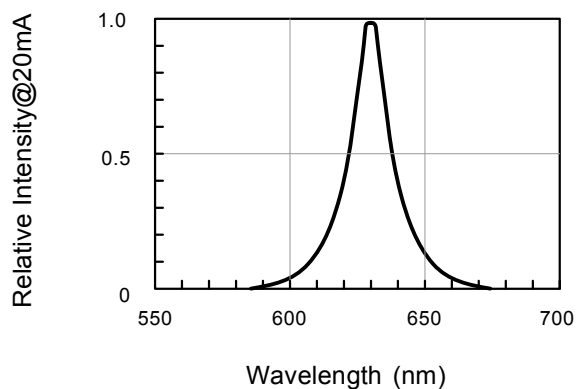
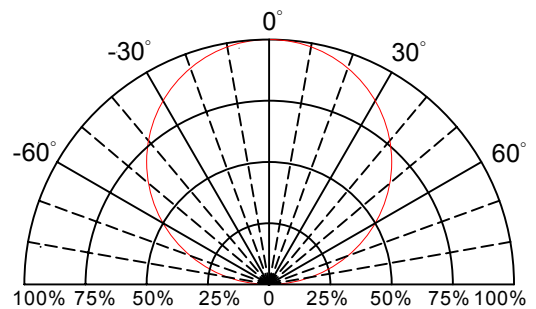

Fig.6 Directive Radiation



Typical Electro-Optical Characteristics Curve

DGM CHIP

Fig.1 Forward current vs. Forward Voltage

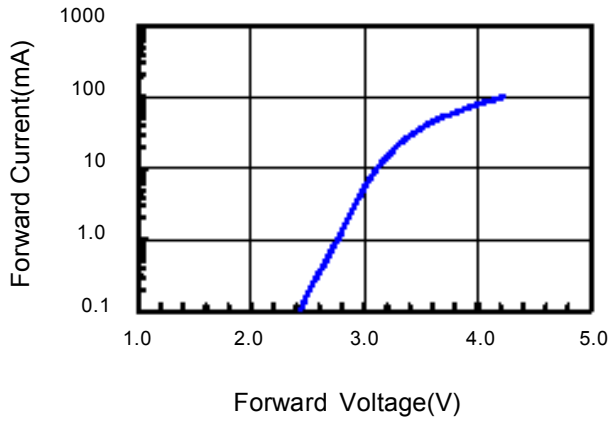

Fig.2 Relative Intensity vs. Forward Current

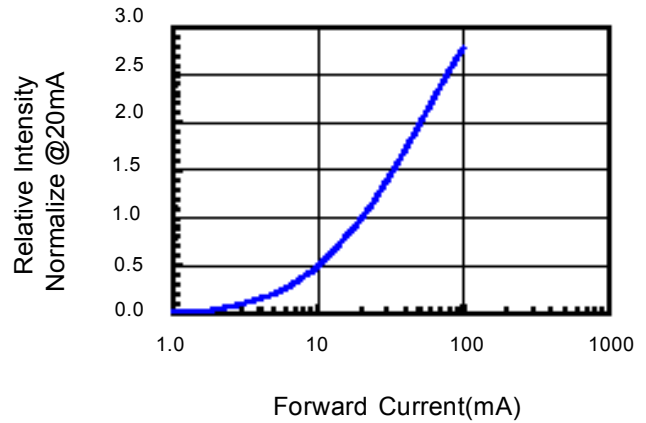

Fig.3 Forward Voltage vs. Temperature

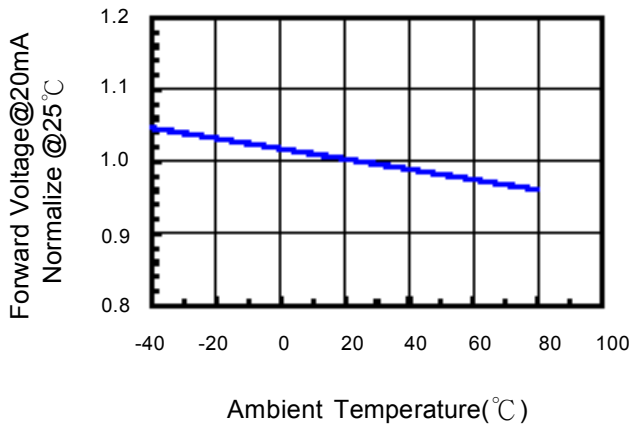

Fig.4 Relative Intensity vs. Temperature

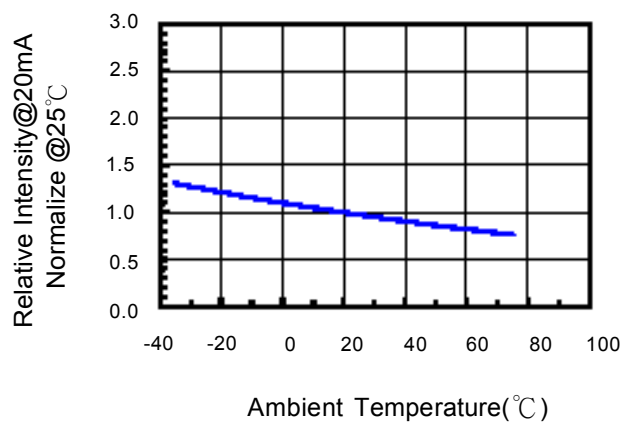

Fig.5 Relative Intensity vs. Wavelength

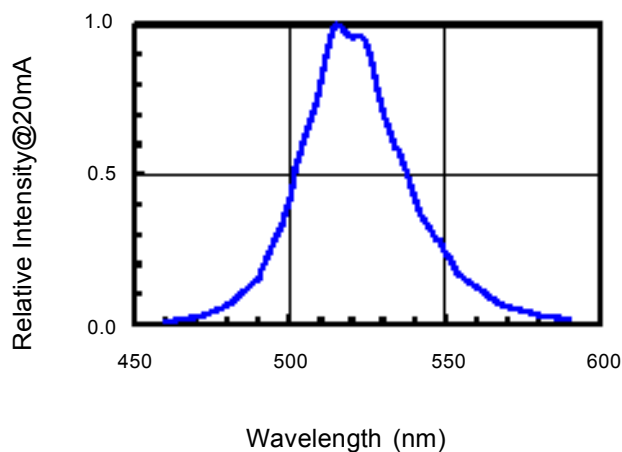
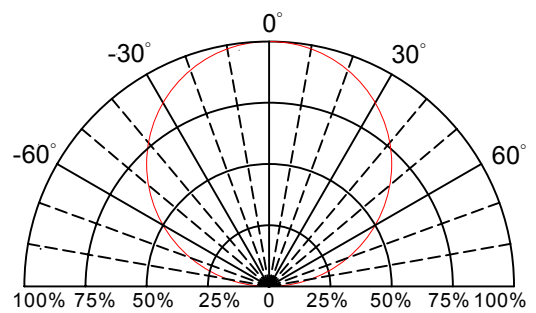

Fig.6 Directive Radiation



Typical Electro-Optical Characteristics Curve

DBK CHIP

Fig.1 Forward current vs. Forward Voltage

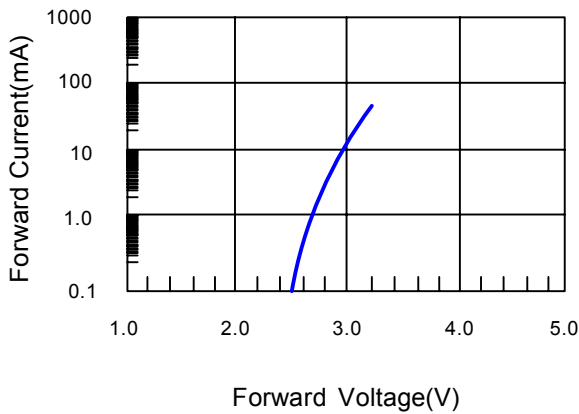

Fig.2 Relative Intensity vs. Forward Current

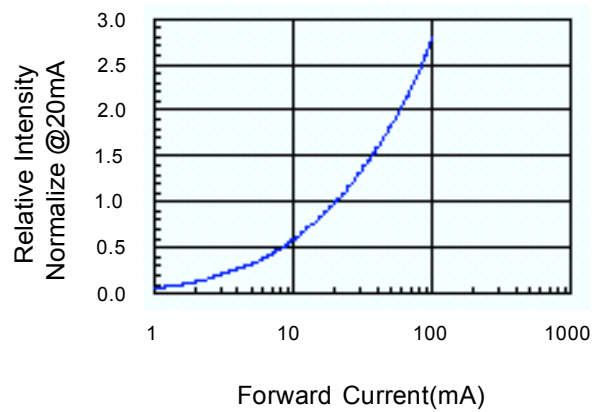

Fig.3 Forward Voltage vs. Temperature

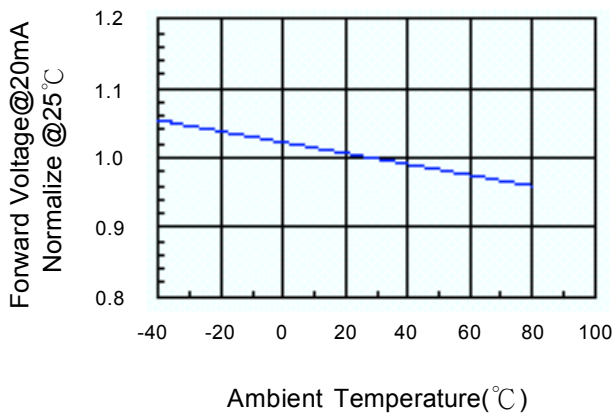

Fig.4 Relative Intensity vs. Temperature

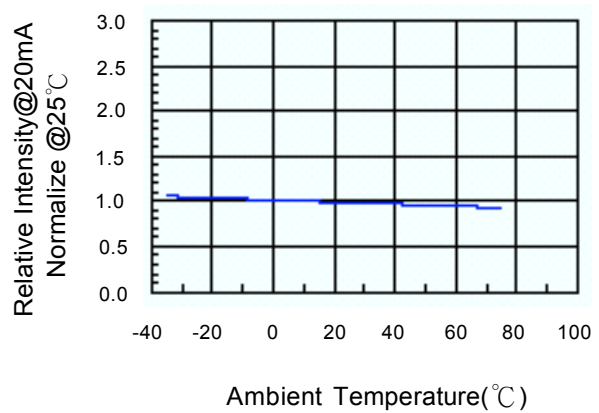

Fig.5 Relative Intensity vs. Wavelength

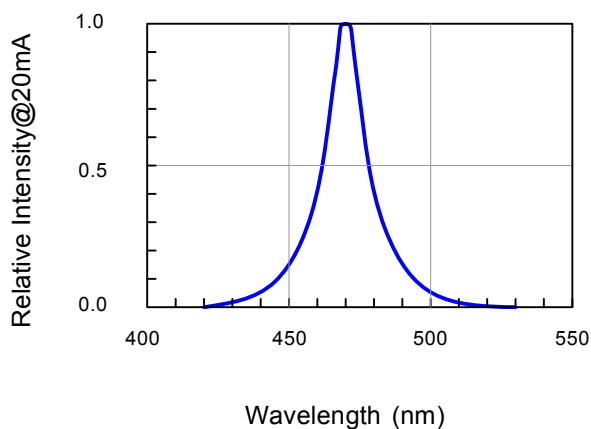
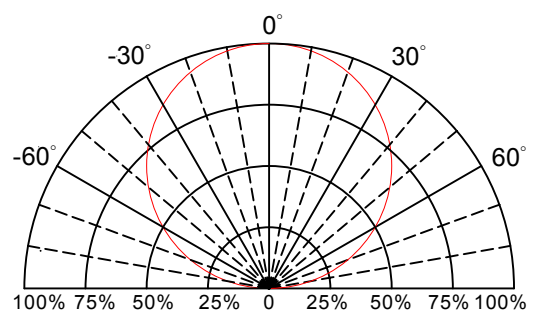
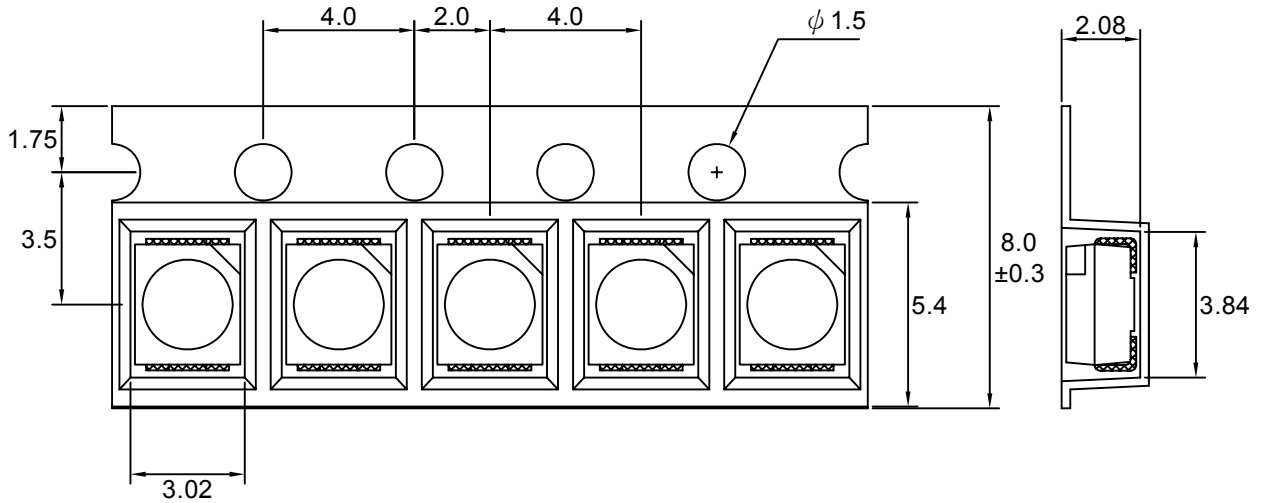

Fig.6 Directive Radiation



Carrier Type Dimensions





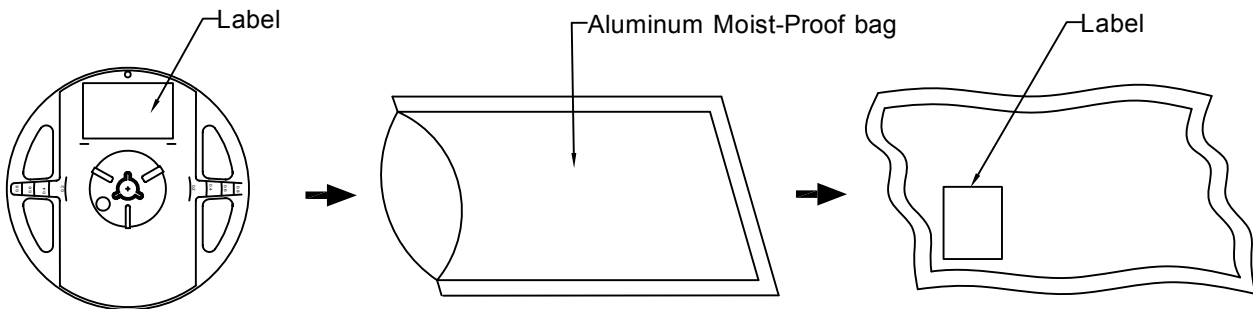

Note : The tolerances unless mentioned is $\pm 0.1\text{mm}$, Angle ± 0.5 . Unit=mm.

• Packing Specifications



Part No.	Description	Quantity/Reel
LRGB9553/S32	8.0mm tape,7"reel	2000 PCS

Label Explanation

	LIGITEK ELECTRONICS CO., LTD.		
			
	PART :	LRGB9553/S32	
	LOT :	GS11560168	 VF:1.5-2.4
	QTY(PCS):	2000	 VF:2.8-3.6
BIN/HUE :	S-T-S	 VF:2.8-3.6	

BIN : Luminous Intensity

VF : Forward Voltage

Reel Dimensions

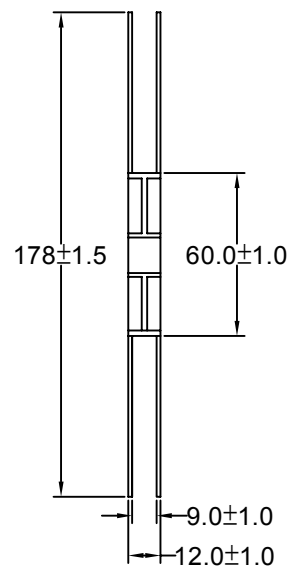
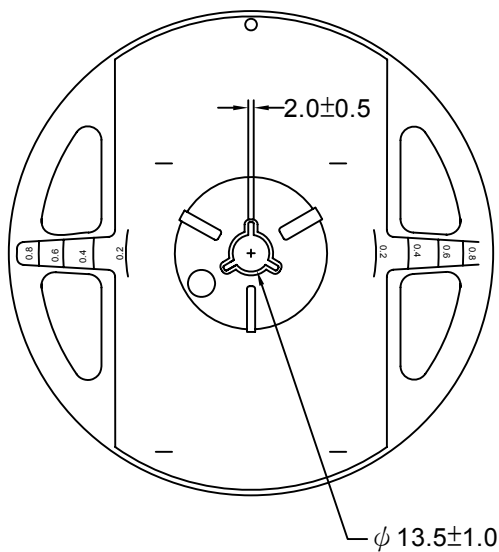

Box Explanation

1. 5 BAG / INNER BOX

2. INNER BOX SIZE : L X W X H 23cm X 8.5cm x 26cm

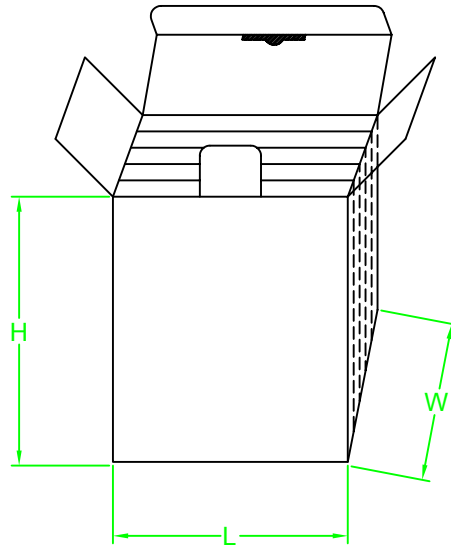

3. 10 INNER BOXES / CARTON

4. CARTON SIZE : L X W X H 58cm X 34cm x 35cm

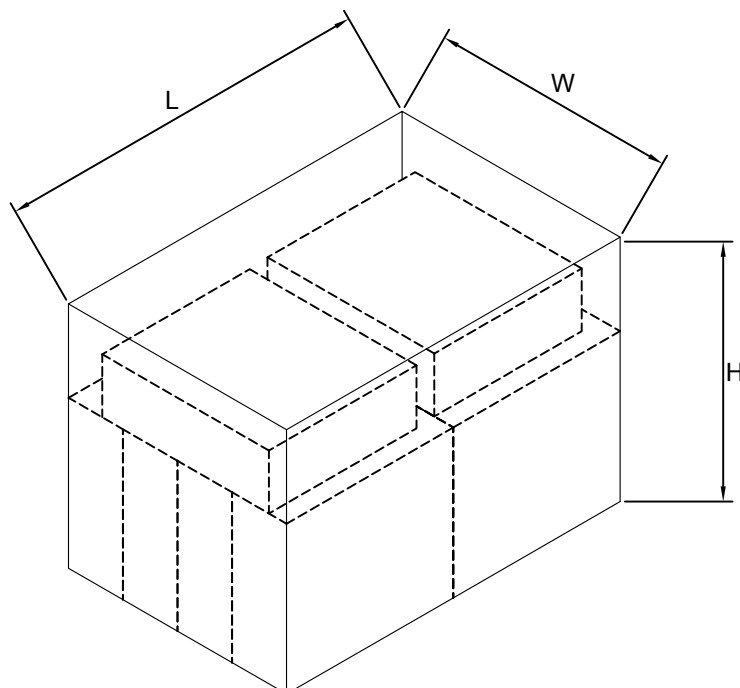

Recommended Soldering Conditions**1. Hand Solder**

Basic spec is $\leq 320^{\circ}\text{C}$ 3 sec one time only.

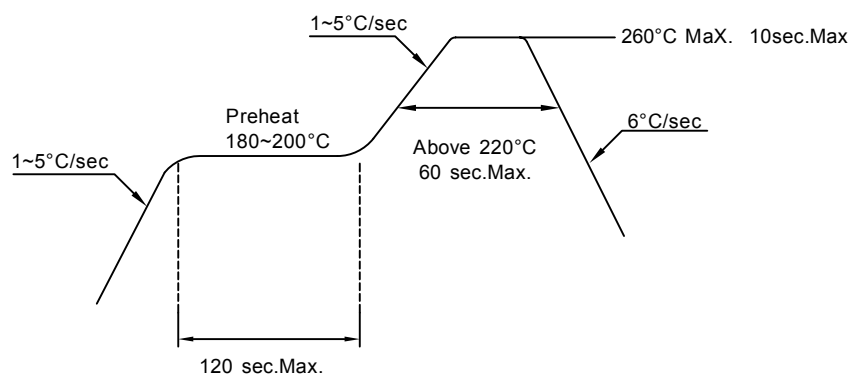
2. PB-Free Reflow Solder**Note:**

- 1.Reflow soldering should not be done more than two times.
- 2.When soldering,do not put stress on the LEDs during heating.
- 3.After soldering,do not warp the circuit board.

Precautions For Use:**Storage time:**

1. Calculated shelf life before opening is 12 months at $< 30^{\circ}\text{C}$ and $< 90\%$ relative humidity (RH)
2. After bag is opened, devices which will be subjected to reflow soldering or other high temperature processes must be
 - a) Assembled within 168 hours in an environment of $\leq 30^{\circ}\text{C} / 60\%$ RH, or
 - b) Stored at ambient of 10% RH or less
3. Devices are required baking before assembly if:
 - a) Humidity Indicator Card reads $>10\%$ (for level 2a -5a) or $>60\%$ (for level 2) at ambient temperature $23 \pm 5^{\circ}\text{C}$
 - b) 2.a) or 2.b) doesn't meet
4. If baking is required, devices should be baked for >24 hours at $60 \pm 5^{\circ}\text{C}$. Performing baking only once, and using the baked devices within 72 hours.

Drive Method:

LED is a current operated device, and therefore, requires some kind of current limiting incorporated into the driver circuit. This current limiting typically takes the form of a current limiting resistor placed in series with the LED.

Consider worst case voltage variations than could occur across the current limiting resistor. The forward current should not be allowed to change by more than 40% of its desired value.

Circuit model A

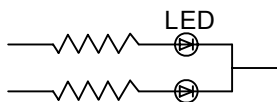

Circuit model B

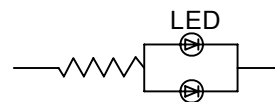

(A) Recommended circuit.

(B) The difference of brightness between LED could be found due to the VF-IF characteristics of LED.

Cleaning:

Use alcohol-based cleaning solvents such as isopropyl alcohol to clean the LED.

ESD(Electrostatic Discharge):

Static Electricity or power surge will damage the LED. Use of a conductive wrist band or anti-electrostatic glove is recommended when handling these LED. All devices, equipment and machinery must be properly grounded.

Reliability Test:

Classification	Test Item	Test Condition	Sample Size
Endurance Test	Operating Life Test	1.Ta=25°C 2.If=20mA 3.t=1000 hrs (-24hrs,+72hrs)	22
	High Temperature Storage Test	1.Ta=100°C±5°C 2.t=1000 hrs (-24hrs,+72hrs)	22
	Low Temperature Storage Test	1.Ta=-40°C±5°C 2.t=1000 hrs (-24hrs,+72hrs)	22
	High Temperature High Humidity Storage Test	1.Ta=85°C 2.RH=85% 3.t=1000hrs(-24hrs,+72hrs)	22
Environmental Test	Thermal Shock Test	1.Ta=100°C±5°C ~ -40°C±5°C 20min/ 10sec / 20min 2.total 100 cycles	22
	Temperature Cycling	1.100°C±5°C ~ -40°C±5°C 30mins / 5mins / 30mins 2.100 Cyeles	22
	IR Reflow	1.T=260°C Max. 10sec.Max. 2. 6 Min	22