

ACDDB540-HF

Reverse Voltage: 40 Volts
Forward Current: 5.0 Amp
RoHS Device
Halogen free

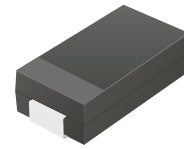

Features

- High current capability.
- High surge current capability.
- Low reverse current.
- Comply with AEC-Q101

Mechanical data

- Case: DO-214AA / SMB, molded plastic.
- Epoxy: UL flammability classification rate 94V-0 .
- Terminals: Lead free plating (Tin finish).
Solderable per MIL-STD-202, Method 208.
- Polarity: Indicated by cathode band.
- Weight: 0.092 grams(approx.).

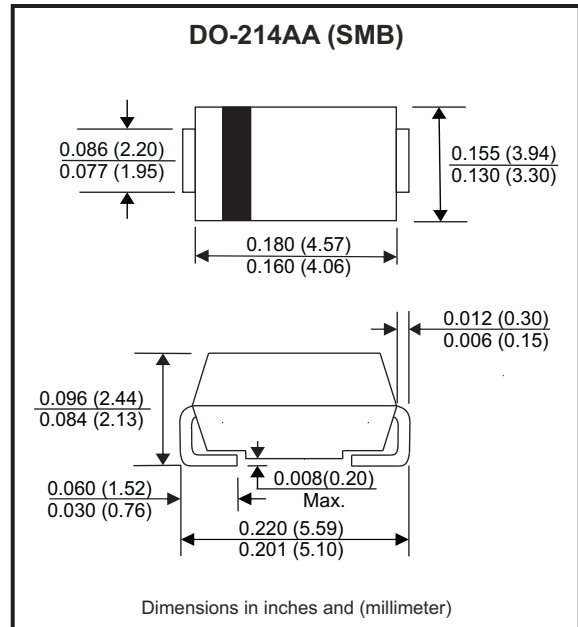

Circuit diagram



Maximum Ratings (at TA=25°C unless otherwise noted)

Parameter	Conditions	Symbol	MIN.	TYP.	MAX.	Unit
Repetitive peak reverse voltage		V_{RRM}			40	V
DC blocking voltage		V_{DC}			40	V
RMS voltage		V_{RMS}			28	V
Average forward rectified current		I_F			5	A
Peak forward surge current	8.3ms single half sine-wave superimposed on rate load (JEDEC method)	I_{FSM}			100	A
Operating Temperature range		T_J	-55		+125	°C
Storage temperature range		T_{STG}	-55		+150	°C

Electrical Characteristics (at TA=25°C unless otherwise noted)

Parameter	Conditions	Symbol	MIN.	TYP.	MAX.	Unit
Instantaneous forward voltage	$I_F = 5A, T_A = 25^\circ C$	V_F			0.55	V
Reverse Current	$V_R = V_{RRM}, T_A = 25^\circ C$	I_R			0.5	mA
	$V_R = V_{RRM}, T_A = 100^\circ C$	I_R			10	mA
Junction capacitance (Note 1)	f=1MHz and applied 4V DC reverse Voltage	C_J		300		pF
Thermal Resistance	Junction to case	$R_{\theta JC}$		15		°C/W

Note: 1. Measured at 1.0MHZ and applied reverse voltage of 4.0V DC.

Company reserves the right to improve product design , functions and reliability without notice.

REV: A

Rating and Characteristics Curvers (ACDBB540-HF)

Fig.1 - Typical Forward Current Derating Curve

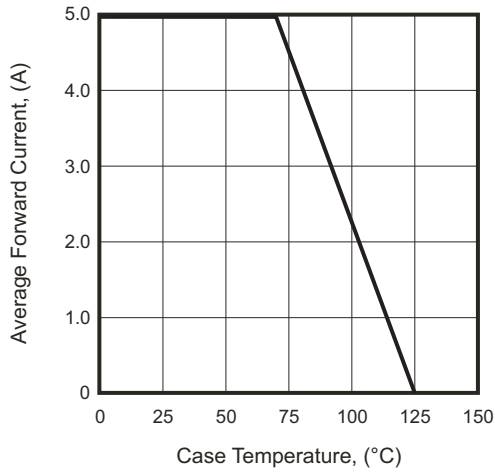

Fig.2 - Typical Forward Characteristics

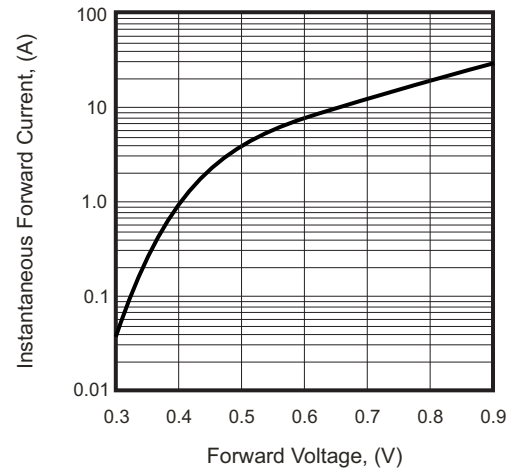

Fig.3 - Maximum Non-repetitive Forward Surge Current

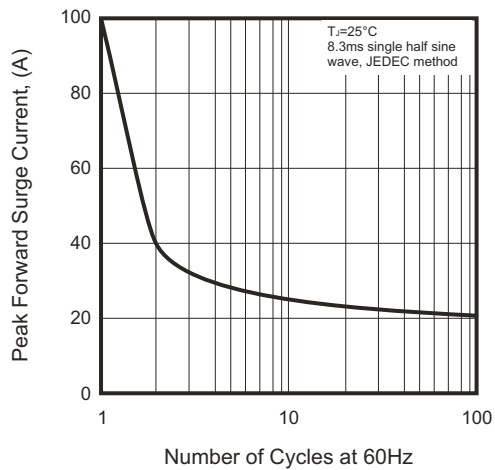

Fig.4 - Typical Reverse Characteristics

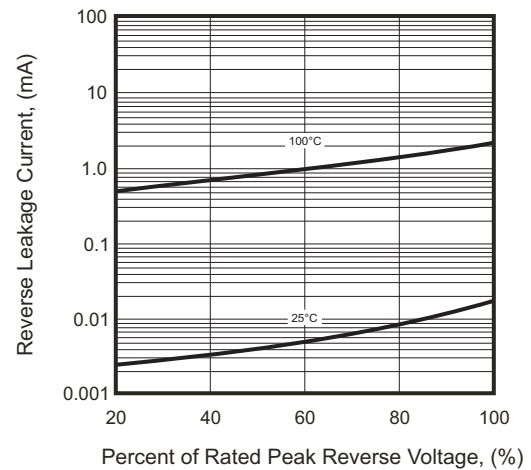
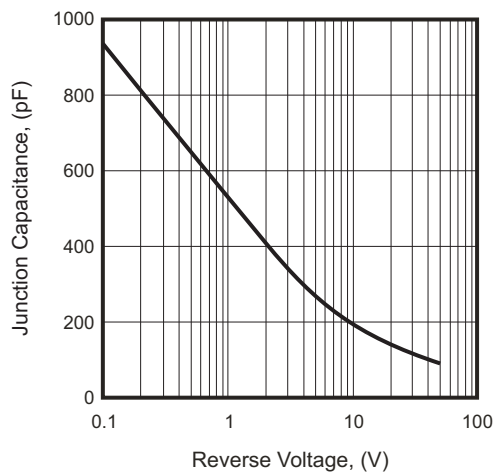

Fig.5 - Typical Junction Capacitance



Company reserves the right to improve product design , functions and reliability without notice.

REV: A

Reel Taping Specification



DO-214AA (SMB)	SYMBOL	A	B	C	d	D	D ₁	D ₂
	(mm)	4.00 MAX.	5.90 MAX.	3.00 MAX.	1.50 ± 0.10	330 ± 2.00	50 MIN.	13.50 ± 1.00
	(inch)	0.157 MAX.	0.232 MAX.	0.118 MAX.	0.059 ± 0.004	13.00 ± 0.079	1.969 MIN.	0.531 ± 0.039

DO-214AA (SMB)	SYMBOL	E	F	P	P ₀	P ₁	W	W ₁
	(mm)	1.75 ± 0.10	5.50 ± 0.05	8.00 ± 0.10	4.00 ± 0.10	2.00 ± 0.05	12.00 ± 0.30	18.40 MAX.
	(inch)	0.069 ± 0.004	0.217 ± 0.002	0.315 ± 0.004	0.157 ± 0.004	0.079 ± 0.002	0.472 ± 0.012	0.724 MAX.

Company reserves the right to improve product design, functions and reliability without notice.

REV: A

Marking Code

Part Number	Marking Code
ACDBB540-HF	540

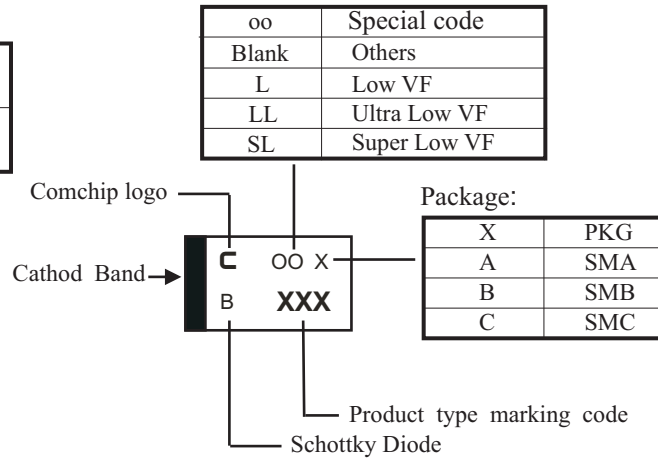

xxx = Product type marking code

Suggested PAD Layout

SIZE	DO-214AA (SMB)	
	(mm)	(inch)
A	2.30	0.091
B	2.50	0.098
C	1.80	0.071
D	4.30	0.169
E	6.80	0.268

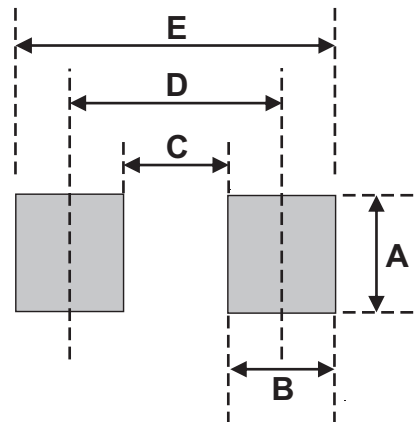

Note:

1. The pad layout is for reference purposes only.

Standard Packaging

Case Type	REEL PACK	
	REEL (pcs)	Reel Size (inch)
DO-214AA (SMB)	3,000	13