

ULN2003A, ULN2003AD, ULN2004A, ULN2004AD

7CH DARLINGTON SINK DRIVER

The ULN2003A/AD Series are high-voltage, high-current darlington drivers comprised of seven NPN darlington pairs.

All units feature integral clamp diodes for switching inductive loads.

Applications include relay, hammer, lamp and display (LED) drivers.

FEATURES

- Output current (single output) 500mA MAX.
- High sustaining voltage output
50V MIN. (ULN2003A/AD Series)
- Output clamp diodes
- Inputs compatible with various types of logic
- Package Type-A : DIP-16pin
- Package Type-AD : SOP-16pin

TYPE	INPUT BASE RESISTOR	DESIGNATION
ULN2003A/AD	2.7k	TTL, 5V CMOS
ULN2004A/AD	10.5 k	6~15V PMOS, CMOS

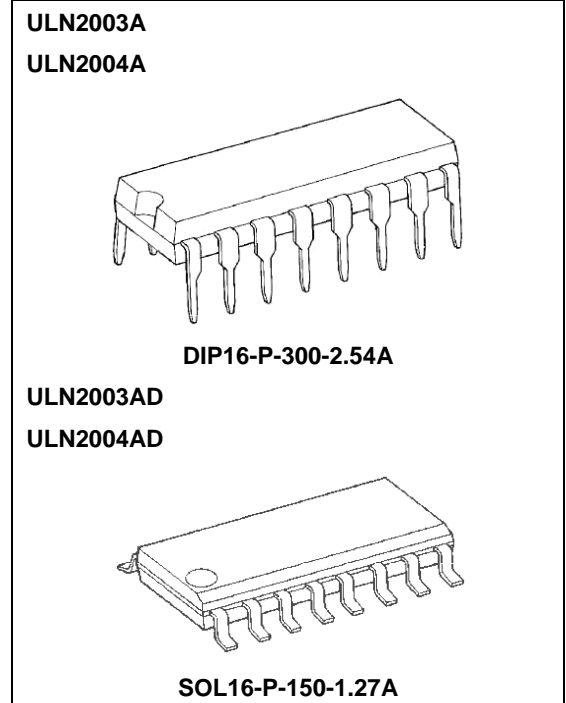

Weight

DIP16-P-300-2.54A : 1.11g (Typ.)

SOP16-P-150-1.27A : 0.15g (Typ.)

PIN CONNECTION (TOP VIEW)

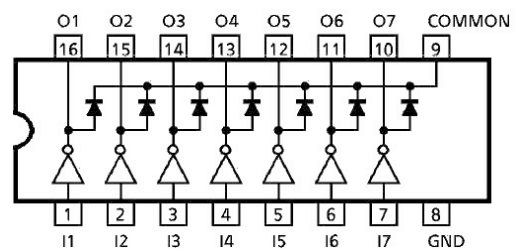

980910EBA1

SCHEMATICS (EACH DRIVER)

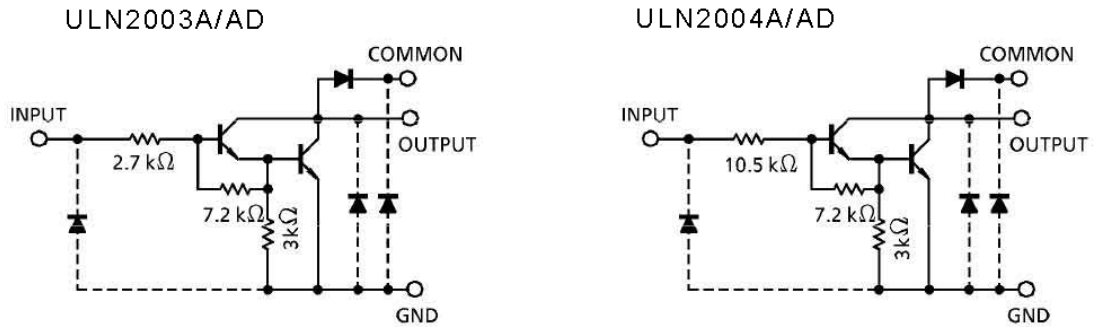

(Note) : The input and output parasitic diodes cannot be used as clamp diodes.

MAXIMUM RATINGS (Ta = 25 °C)

CHARACTERISTIC		SYMBOL	RATING	UNIT
Output Sustaining Voltage		$V_{CE(SUS)}$	-0.5~50	V
Output Current		I_{OUT}	500	mA/ch
Input Voltage		V_{IN}	-0.5~30	V
Clamp Diode Reverse Voltage		V_R	50	V
Clamp Diode Forward Current		I_F	500	mA
Power Dissipation	A	P_D	1.47	W
	AD		0.54/0.625 (Note)	
Operating Temperature		T_{opr}	-40~85	
Storage Temperature		T_{stg}	-55~150	

(Note) : On glass epoxy PCB (30 x 30 x 1.6mm Cu 50%)

RECOMMENDED OPERATING CONDITIONS (Ta= -40-85)

CHARACTERISTIC		SYMBOL	CONDITION	MIN.	TYP.	MAX.	UNIT	
Output Sustaining Voltage		V _{CE (SUS)}		0	-	50		
Output current	A	I _{OUT}	T _{pw} = 25ms 7 Circuits	Duty=10%	0	-	370	mA/ch
				Duty=50%	0	-	130	
	AD		Ta =85	Duty=10%	0	-	233	
			Tj=120	Duty=50%	0	-	70	
Input Voltage		V _{IN}		0	-	24	V	
Input Voltage (Output On)	ULN2003A	V _{IN(ON)}	I _{OUT} =400mA h _{FE} =800	2.8	-	24	V	
	ULN2004A			6.2	-	24		
Input Voltage (Output Off)	ULN2003A	V _{IN(OFF)}		0	-	0.7	V	
	ULN2004A			0	-	1.0		
Clamp Diode Reverse Voltage		V _R		-	-	50	V	
Clamp Diode Forward Current		I _F		-	-	350	mA	
Power Dissipation	A	P _D	Ta =85	-	-	0.76	W	
	AD		(Note) Ta =85	-	-	0.325		

(Note) : On glass epoxy PCB (30 X 30 X1.6mm Cu 50%)

ELECTRICAL CHARACTERISTICS (Ta =25 unless otherwise noted)

CHARACTERISTIC	SYMBOL	TEST CIRCUIT	TEST CONDITION	MIN.	TYP.	MAX.	UNIT			
Output Leakage Current	I _{CEX}	1	V _{CE} = 50V, Ta = 25	-	-	50	μA			
			V _{CE} = 50V, Ta = 85	-	-	100				
Collector-Emitter Saturation Voltage	V _{CE(sat)}	2	I _{OUT} = 350mA, I _{IN} = 500 μA	-	1.3	1.6	V			
			I _{OUT} = 200mA, I _{IN} = 350 μA	-	1.1	1.3				
			I _{OUT} = 100mA, I _{IN} = 250 μA	-	0.9	1.1				
DC Current Transfer Ratio	h _{FE}	2	V _{CE} = 2V, I _{OUT} = 350mA	1000	-	-				
Input Current (Output On)	ULN2003A	I _{IN(ON)}	3	V _{IN} = 2.4V, I _{OUT} = 350mA	-	0.4	0.7	mA		
	ULN2004A								V _{IN} = 9.5V, I _{OUT} = 350mA	-
Input Current (Output Off)	I _{IN(OFF)}	4	I _{OUT} = 500 μA, Ta =85	50	65	-	μA			
Input Voltage (Output On)	ULN2003A	V _{IN(ON)}	5	V _{CE} = 2V H _{FE} = 800		I _{OUT} = 350mA	-	-	3.2	V
						I _{OUT} = 200mA	-	-	2.5	
	ULN2004A					I _{OUT} = 350mA	-	-	4.7	
						I _{OUT} = 200mA	-	-	4.4	
Clamp Diode Reverse Current	I _R	6	V _R = 50V, Ta = 25	-	-	50	μA			
			V _R = 50V, Ta = 85	-	-	100				
Clamp Diode Forward Voltage	V _F	7	I _F = 350 mA	-	-	2.0	V			
Input Capacitance	C _{IN}	-		-	15	-	pF			
Turn-On Delay	t _{ON}	8	V _{OUT} = 50V, R _L = 125 C _L = 15pF	-	0.1	-	μS			
Turn-Off Delay	t _{OFF}	8	V _{OUT} = 50V, R _L = 125 C _L = 15pF	-	0.2	-				

TEST CIRCUIT

1. I_{CEX}

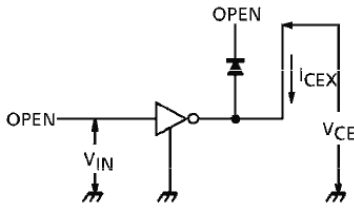

2. $V_{CE(sat)}$, h_{FE}

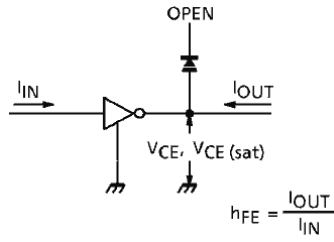

3. $I_{IN(ON)}$

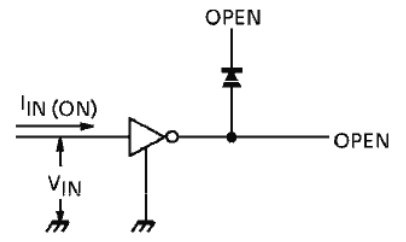

4. $I_{IN(OFF)}$

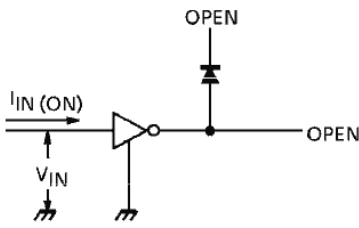

5. $V_{IN(ON)}$

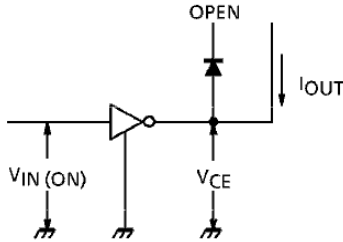

6. I_R

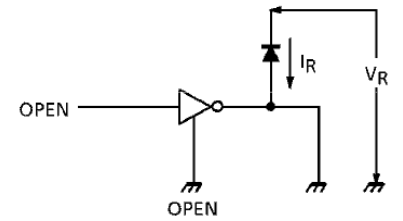

7. V_F

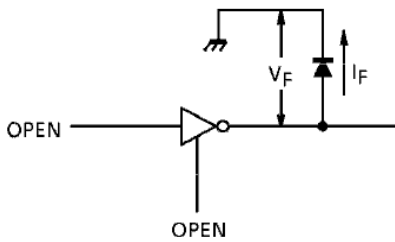

8. t_{ON} , t_{OFF}

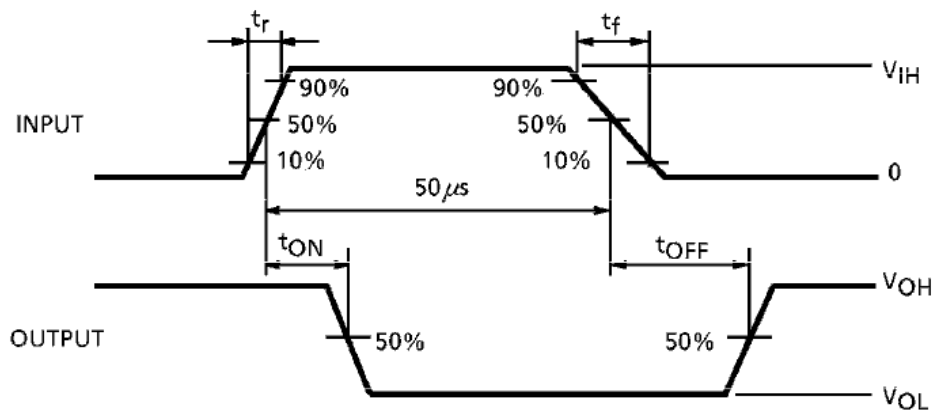
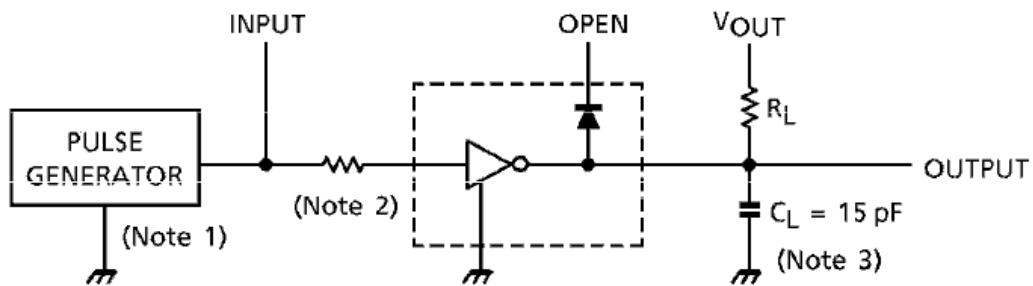

- (Note 1) : Pulse width $50 \mu s$, duty cycle 10%
 Output impedance 50Ω , t_r 5ns, t_f 10ns
- (Note 2) : See below

INPUT CONDITION

TYPE NUMBER	R1	V_{IH}
ULN2003A/AD	0	3V
ULN2004A/AD	0	8V

- (Note 3) : C_L includes probe and jig capacitance.

PRECAUTIONS for USING

Utmost care is necessary in the design of the output line, COMMON and GND line since IC may be destroyed due to short-circuit between outputs, air contamination fault, or fault by improper grounding.

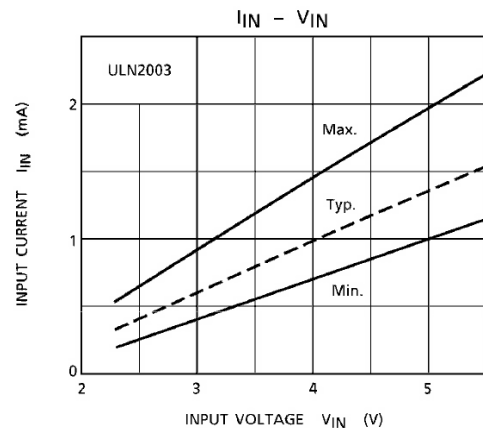
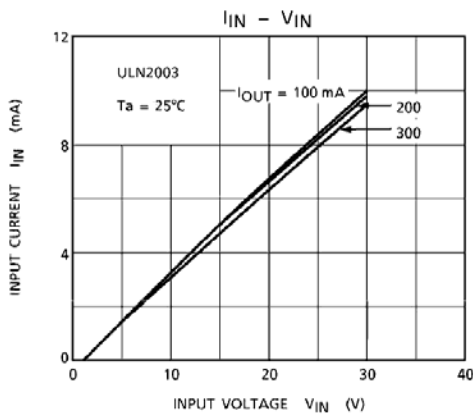
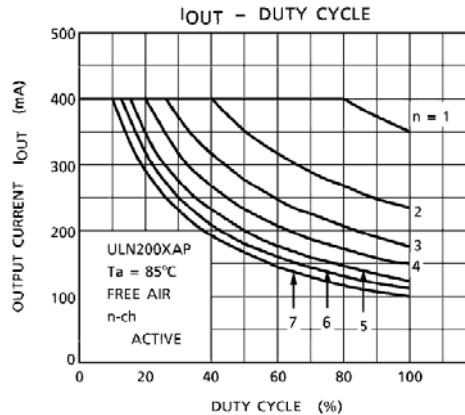
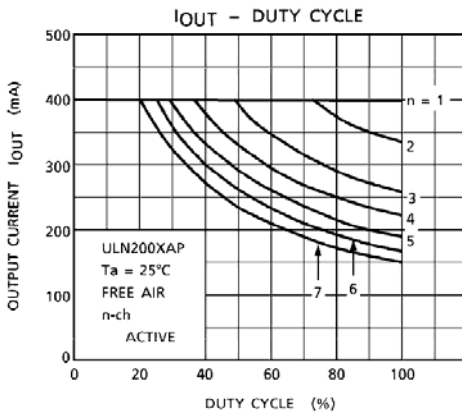
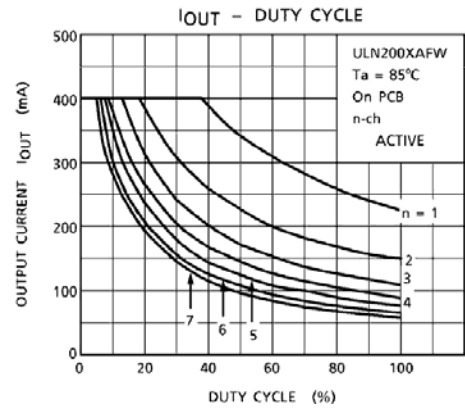
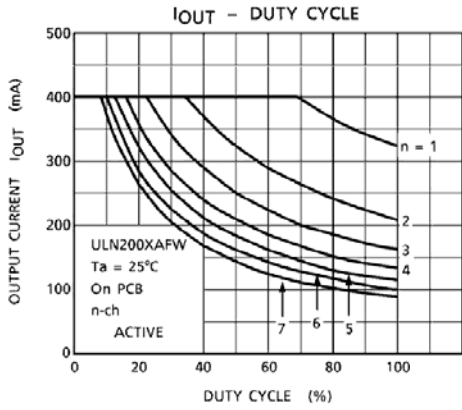

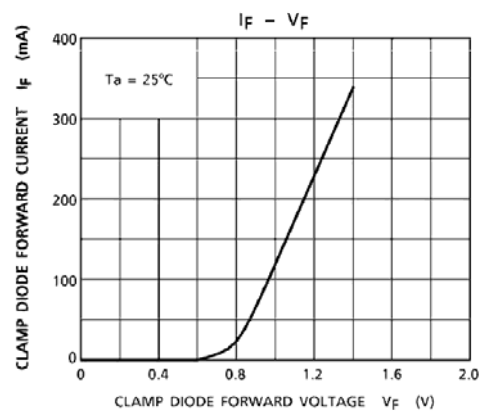
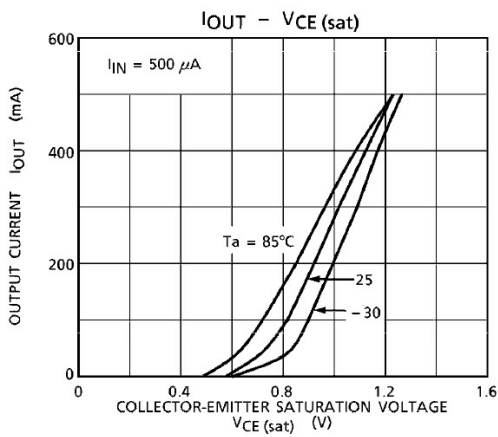
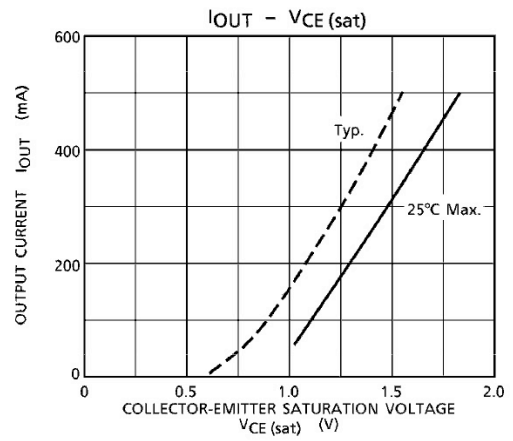
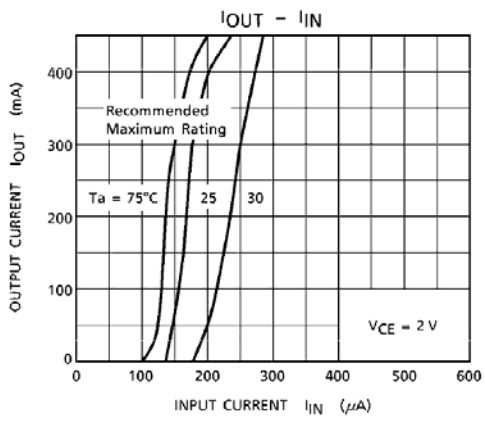
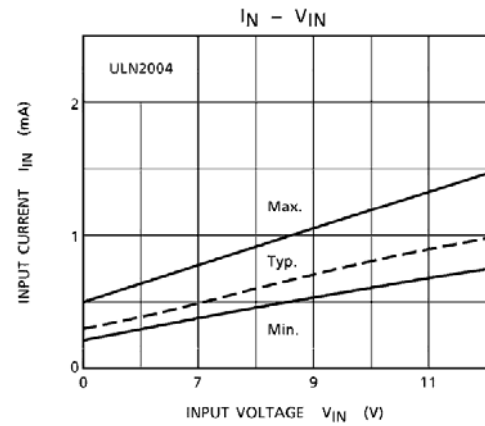
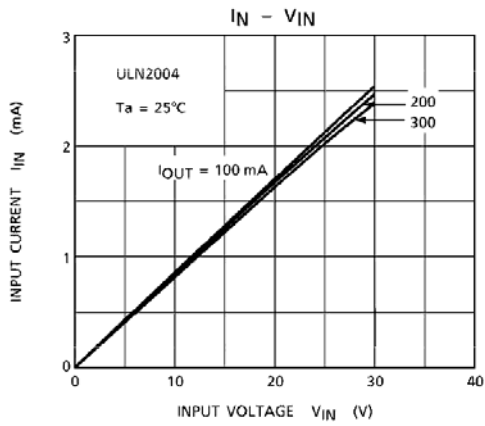

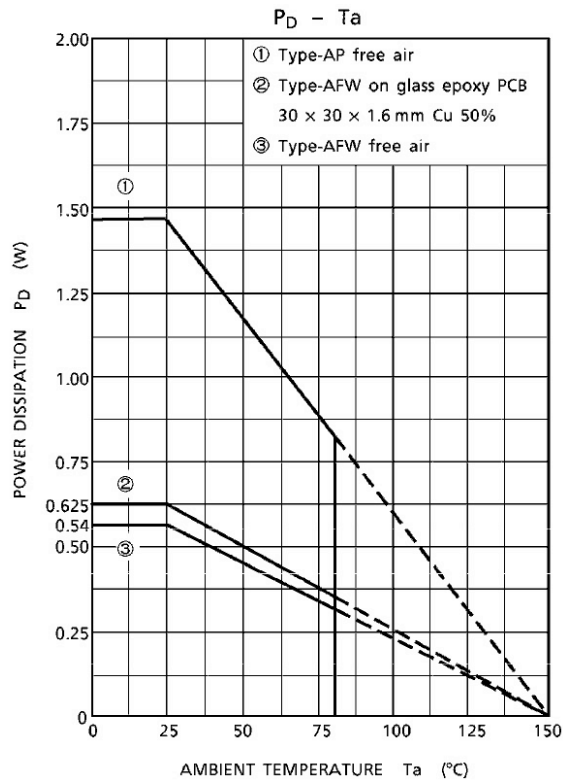
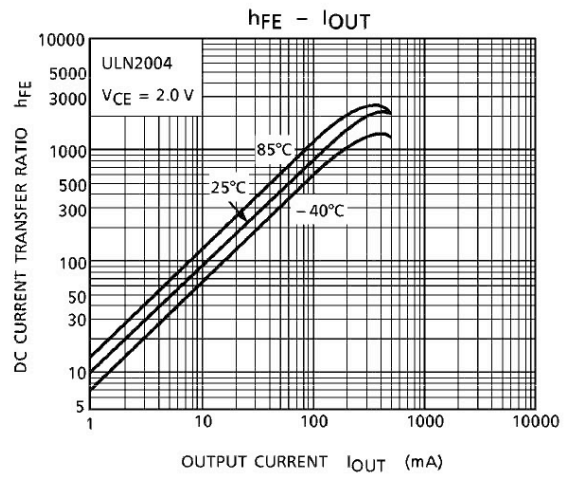
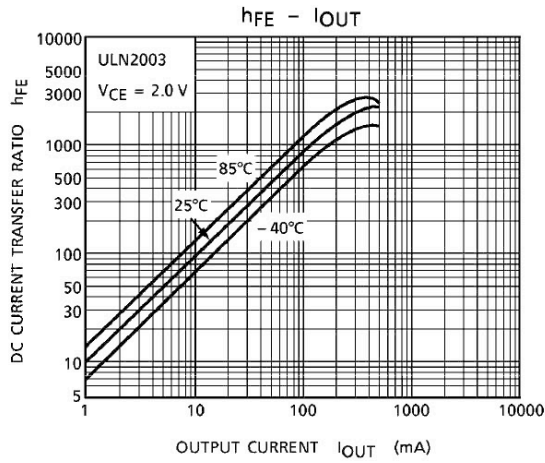

OUTLINE DRAWING

DIP16-P-300-2.54A

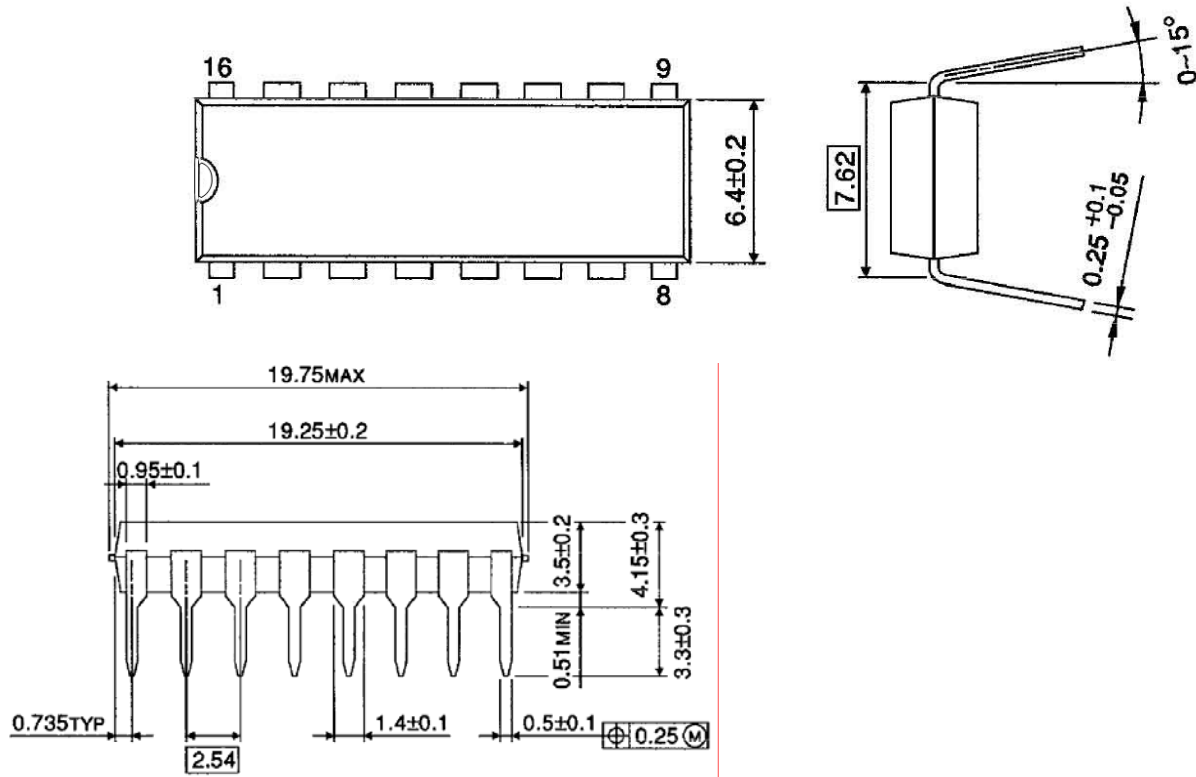

Weight : 1.11g (Typ.)

OUTLINE DRAWING
SOL16-P-150-1.27A

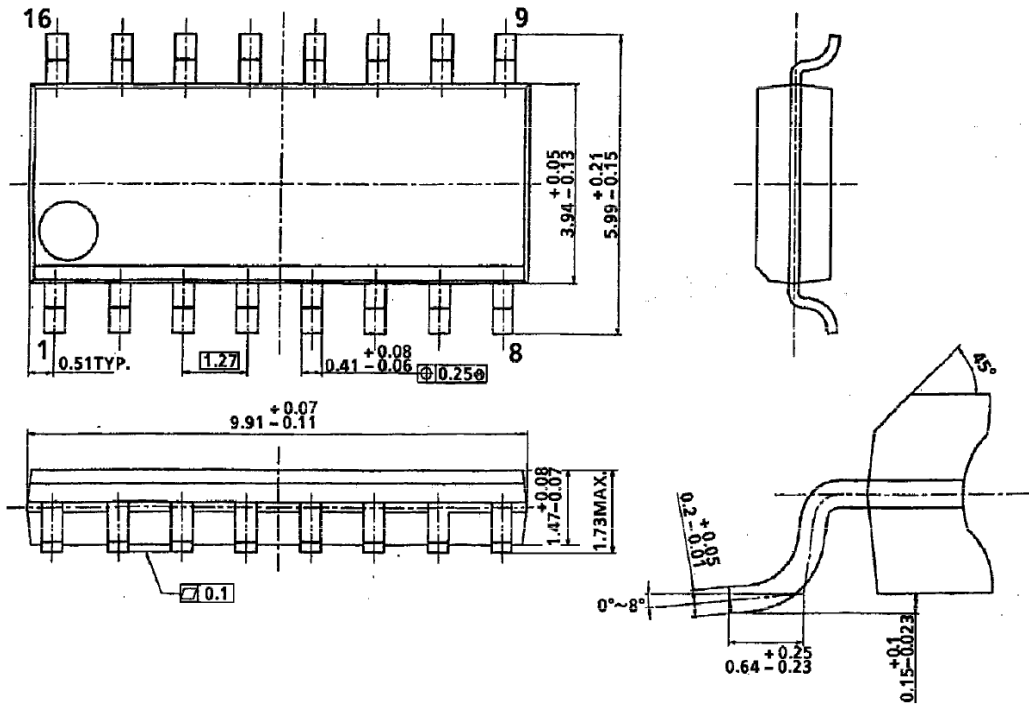

Weight : 0.15g (Typ.)